



Sigma 8KS

from serial no. 162923



Operating Manual

Please retain for later use!

© Copyright by
Sigma Laborzentrifugen GmbH
An der Unteren Söse 50
37520 Osterode am Harz
Germany

Tel.: +49 (0) 5522 / 5007-0
Fax: +49 (0) 5522 / 5007-12
Web: www.sigma-zentrifugen.de
E-mail: info@sigma-zentrifugen.de

1	General information	9
1.1	Importance of the operating manual	9
1.2	Further applicable documents	9
1.3	Intended use	9
1.4	Warranty and liability	10
1.5	Copyright	10
1.6	Standards and regulations	10
1.7	Scope of supply	11
2	Layout and mode of operation	12
2.1	Layout of the centrifuge	12
2.1.1	Functional and operating elements	12
2.1.2	Name plate	15
2.2	Mode of operation	16
2.2.1	Centrifugation principle	16
2.2.2	Area of application	16
2.2.2.1	Speed, radius, and relative centrifugal force	17
2.2.2.2	Density	17
3	Safety	18
3.1	Marking of the unit	18
3.2	Explanation of the symbols and notes	19
3.3	Responsibility of the operator	20
3.4	Requirements concerning the personnel	21
3.5	Informal safety instructions	22
3.6	Safety instructions	23
3.6.1	Electrical safety	23
3.6.2	Mechanical safety	23
3.6.3	Fire prevention	24
3.6.4	Chemical and biological safety	24
3.6.5	Safety instructions for centrifugation	25
3.6.6	Resistance of plastics	25
3.6.7	Rotors and accessories	26
3.6.7.1	Lifting and carrying rotors	26
3.6.7.2	Service life of rotors and accessories	26
3.6.8	Safety of rotors and accessories	27
3.6.8.1	Marking	27
3.7	Safety devices	29
3.7.1	Lid lock device	29
3.7.2	Standstill monitoring system	29
3.7.3	System check	29
3.7.4	Earth conductor check	29
3.7.5	Imbalance monitoring system	29
3.7.6	Temperature monitoring system	29
3.7.7	Rotor monitoring system	29

Table of contents

3.8	Measures in the event of hazards and accidents	30
3.9	Remaining hazards.....	30
4	Storage and transport	31
4.1	Storage conditions	31
4.2	Transport.....	31
5	Set-up and connection	32
5.1	Condensate drain	32
5.2	Cover holder.....	33
6	Using the centrifuge	34
6.1	Initial start-up	34
6.2	Switching the centrifuge on.....	34
6.2.1	Opening and closing the lid.....	34
6.2.2	Installation of rotors and accessories	35
6.2.2.1	Installation of a rotor	35
6.2.2.2	Installation of an angle rotor with a hermetic lid.....	37
6.2.2.3	Installation of accessories	38
6.2.2.4	Adapters	39
6.2.2.5	Vessels	39
6.2.2.6	Blood bag systems.....	40
6.3	Control system "Spincontrol S"	42
6.3.1	User interface	42
6.3.2	Manual mode.....	43
6.3.2.1	Starting a centrifugation run	43
6.3.2.2	Interrupting a centrifugation run	43
6.3.2.3	Interrupting a deceleration process	43
6.3.2.4	Selection, display, and modification of data.....	43
6.3.2.5	Standard menu	44
6.3.2.6	Process library menu	50
6.3.2.7	Parameters menu	51
6.3.2.8	Setup menu	55
6.3.2.9	Curve menu	58
6.3.2.10	Option: Barcode menu	59
6.3.2.11	Help menu	61
6.3.2.12	Changing the contrast.....	62
6.3.3	Program mode.....	62
6.3.3.1	Saving a program.....	63
6.3.3.2	Loading a program.....	63
6.3.3.3	Executing a program	64
6.3.3.4	Deleting a program	64
6.3.3.5	Automatic program rotation.....	65
6.3.4	Options for data input and output.....	66
6.3.5	Connection of a separate computer	66
6.4	Switching the centrifuge off	66

Table of contents

7	Malfunctions and error correction	67
7.1	General malfunctions.....	67
7.1.1	Emergency lid release.....	68
7.2	Table of error codes.....	69
7.3	Service contact.....	70
8	Maintenance and service	71
8.1	Maintenance.....	71
8.1.1	Centrifuge.....	71
8.1.1.1	Condenser (only refrigerated centrifuges with an air-cooled refrigeration system)	72
8.1.2	Accessories.....	72
8.1.2.1	Plastic accessories.....	73
8.1.3	Rotors, buckets and carriers.....	73
8.1.4	Load bearing bolts.....	74
8.1.5	Glass breakage.....	75
8.2	Sterilisation and disinfection of the rotor chamber and accessories.....	75
8.2.1	Autoclaving.....	76
8.3	Service.....	77
8.4	Return of defective centrifuges or parts.....	78
9	Disposal	80
9.1	Disposal of the centrifuge.....	80
9.2	Disposal of the packaging.....	80
10	Technical data	81
10.1	Ambient conditions.....	82
10.2	Technical documentation.....	82
11	Appendix	83
11.1	Range of accessories.....	83
11.1.1	Rotor radii.....	83
11.2	Speed-gravitational-field-diagram.....	84
11.3	Acceleration and deceleration curves.....	85
11.4	Table of the service life of rotors and accessories.....	87
11.5	Resistance data.....	88
11.6	Serial Control Interface Specification.....	93
11.7	EC declaration of conformity.....	117
11.8	Declaration of conformity – China RoHS 2.....	119
11.9	UKCA declaration of conformity.....	121
12	Index	123

Table of contents

1 General information

1.1 Importance of the operating manual

A fundamental requirement for the safe and trouble-free operation of the centrifuge is to be familiar with the fundamental safety instructions and all possible hazards.

The operating manual includes important information concerning the safe operation of the centrifuge.

This operating manual and, in particular, the notes on safety and hazards must be observed by all persons operating the centrifuge.

In addition, the local rules and regulations for the prevention of accidents must be complied with.

1.2 Further applicable documents

The following documents apply in addition to these operating instructions:

- Transport and installation instructions of the refrigerated centrifuge Sigma 8KS (part no. 07042)

1.3 Intended use

Centrifuges are power-driven machines that separate liquids from solid matter, liquid mixtures, or solid mixtures by centrifugal force. They are solely intended for this purpose. Any other use beyond this area of application is regarded as improper use. Sigma Laborzentrifugen GmbH cannot be held liable for any damage resulting from such improper use.

The intended use also includes

- observation of all the notes and instructions included in the operating manual and
- compliance with the care, cleaning, and maintenance instructions.

1 General information

1.4 Warranty and liability

The warranty and liability are subject to our "General Conditions" that were distributed to the operator upon the conclusion of the contract.

Warranty and liability claims are excluded if they are due to:

- improper use.
- non-compliance with the safety instructions and hazard warnings in the operating manual.
- improper installation, start-up, operation, or maintenance of the centrifuge.

1.5 Copyright

The copyright concerning the operating manual remains with Sigma Laborzentrifugen GmbH.

The operating manual is solely intended for the operator and their personnel. It includes instructions and information that must not be

- duplicated,
- distributed, or
- communicated in any other way.

Non-compliance may be prosecuted under criminal law.

1.6 Standards and regulations

These operating instructions have been created in accordance with the relevant European standards and regulations (see chapter 11.7 - "EC declaration of conformity").

1.7 Scope of supply

The centrifuge comprises:

- 1 square spanner, size 8 (door) Part no. 930 114
- 1 open spanner, size 8/10
(adjustable feet front side) Part no. 930 015
- 1 open spanner, size 24
(adjustable feet rear side) Part no. 930 024
- 1 wrench, angulate, size 17/19 (rotor) Part no. 26 448
- 1 tube wrench (emergency release) Part no. 930 110
- 1 wrench, hex socket, size 4 (rotor) Part no. 930 050
- 1 holder for the rotor cover
with hexagon socket head screw (M6x16)
(see chapter 5.2 - "Cover holder") Part no. 28 598
Part no. 964 216
- 1 hose connector for condensate drain
(installed) Part no. 80 415
- 1 tube (30 g) heavy-duty grease for load-bearing
bolts Part no. 71 401

Documentation

Operating manual incl. EC declaration of conformity
(see chapter 11.7 - "EC declaration of conformity")

Accessories

according to your order, our order confirmation, and your delivery note.

2 Layout and mode of operation

2 Layout and mode of operation

2.1 Layout of the centrifuge

2.1.1 Functional and operating elements

- 1 Lid
- 2 User interface (see chapter 6.3.1 - "User interface")



Fig. 1: Total view of the centrifuge

2 Layout and mode of operation

- 3 Locks of the front door
- 4 Name plate (see chapter 2.1.2 - "Name plate")



Fig. 2: Right side of the centrifuge

2 Layout and mode of operation

- 5 Mains power switch
- 6 Condensate drain



Fig. 3: Left side of the centrifuge

- 7 Mains cable
- 8 Option: connector for barcode scanner
- 9 RS-232 interface
- 10 Option: serial interface (see chapter 6.3.4 - "Options for data input and output")
- 11 Castor
- 12 Adjustable foot



Fig. 4: Rear view of an air cooled centrifuge

2 Layout and mode of operation

13 Cooling water connection



Fig. 5: Rear view of a water cooled centrifuge

2.1.2 Name plate

- 1 Manufacturer
- 2 Power consumption
- 3 Max. speed
- 4 Max. kinetic energy
- 5 Serial number
- 6 Part number
- 7 Nominal voltage
- 8 Type
- 9 Consult operating manual
- 10 Symbol for special disposal (see chapter 9 - "Disposal")
- 11 Date of manufacture
- 12 CE mark in compliance with the directive 2006/42/EC
- 13 Max. permissible density
- 14 Refrigerant data

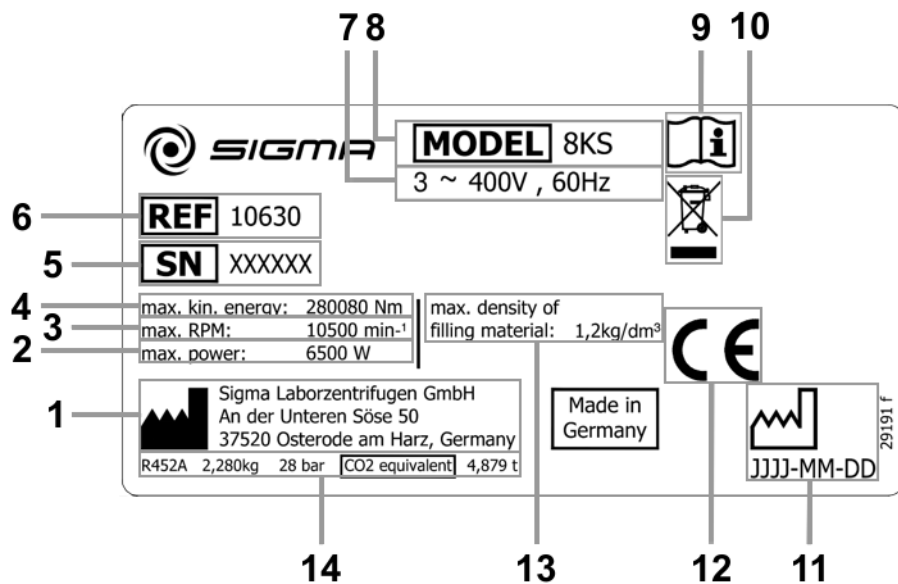

Fig. 6: Example of a name plate

2 Layout and mode of operation

2.2 Mode of operation

2.2.1 Centrifugation principle

Centrifugation is a process for the separation of heterogeneous mixtures of substances (suspensions, emulsions, or gas mixtures) into their components. The mixture of substances, which rotates on a circular path, is subject to centripetal acceleration that is several times greater than the gravitational acceleration.

Centrifuges use the mass inertia inside the rotor chamber for separating the substances. Due to their higher inertia, particles or media with a higher density travel outwards. In doing so, they displace the components with a lower density, which in turn travel towards the centre.

The centripetal acceleration of an object inside a centrifuge, as the effect of centripetal force, depends on the distance between the object and the axis of rotation as well as on the angular velocity. It increases linearly as a function of the distance with regard to the axis of rotation and quadratically as a function of the angular velocity. The bigger the radius in the rotor chamber is and the higher the speed is, the higher the centripetal acceleration is. However, the forces acting on the rotor also increase.

2.2.2 Area of application

Depending on the area of application of the centrifuge and also on the particle size, solids content, and volume throughput of the mixture of substances that is to be centrifuged, there are different types of centrifuges. The areas of application go from household use as a salad spinner or honey separator up to specialised technical applications in the clinical, biological, or biochemical context:

- For numerous clinical examinations, cellular material must be separated from the liquid to be analysed. The normal separation process can be sped up considerably by using laboratory centrifuges.
- In the metal-working industry, centrifuges are used for separating oil from metal cuttings. Dairies use centrifuges in order to separate cow's milk into cream and low-fat milk.
- Particularly big centrifuges are used in the sugar industry for separating the syrup from the crystalline sugar.
- Ultracentrifuges are predominantly used in biology and biochemistry in order to isolate particles, e.g. viruses. They are specifically designed for high speeds up to 500,000 rpm. The rotor moves in a vacuum in order to avoid air friction.

2 Layout and mode of operation

2.2.2.1 Speed, radius, and relative centrifugal force

The acceleration g , which the samples are subject to, can be increased by increasing the radius in the rotor chamber and by increasing the speed. These three parameters are interdependent and linked with each other via the following formula:

$$\text{Relative centrifugal force RCF} = 11.18 \times 10^{-6} \times r \times n^2$$

r = radius in cm

n = speed in rpm

RCF without any dimension

If two values are entered, the third value is determined by way of the stated formula. If, afterwards, the speed or the radius is changed, the resulting relative centrifugal force will be recalculated automatically by the control unit. If the RCF is changed, the speed will be adapted while the specified radius is maintained.

The speed-gravitational-field-diagram provides an overview of the relationship between speed, radius, and RCF (see chapter 11.2 - "Speed-gravitational-field-diagram").

2.2.2.2 Density

The laboratory centrifuge is suitable for the separation of constituents of different densities in mixtures with a maximum density of 1.2 g/cm^3 . All information concerning the speed of rotors and accessories refers to liquids with a density corresponding to this specification. If the density is above this value, the maximum permissible speed of the centrifuge must be reduced based on the following formula:

$$n = n_{max} \times \sqrt{(1.2/\rho)}$$













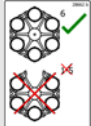

ρ = density in g/cm^3

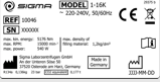
3 Safety

3 Safety

3.1 Marking of the unit

The following symbols are used on this centrifuge:

 <p>On (Power)</p>	 <p>Arrow indicating the direction of rotation</p>
 <p>Off (Power)</p>	 <p>Rotor loading information (see chapter 6.2.2.3 - "Installation of accessories")</p>
 <p>Hot surface</p>	 <p>Bucket loading information (see chapter 6.2.2.3 - "Installation of accessories")</p>
 <p>Attention! General danger</p>	 <p>Note concerning the condensate drain</p>
 <p>Name plate (see chapter 2.1.2 - "Name plate")</p>	 <p>CE mark in compliance with the directive 2006/42/EC</p>
 <p>Do not dispose as part of domestic waste</p>	 <p>Consult operating manual</p>
 <p>NRTL mark (only for the USA and Canada)</p>	 <p>RCM mark (only for Australia)</p>
 <p>China RoHS 2 mark (only for China)</p>	 <p>California Proposition 65 mark (only for the USA)</p>
 <p>UKCA mark (only for UK)</p>	

i
NOTE

Safety indications on the centrifuge must be kept readable at all times. If necessary, they must be replaced.

i
NOTE

The marking varies depending on the version and country of destination of the centrifuge.

3.2 Explanation of the symbols and notes

In this operating manual, the following names and symbols to indicate hazards are used:



This symbol stands for a **direct** hazard to the life and health of persons.

Non-observance of these symbols **causes** serious health problems up to life-endangering injuries.



This symbol stands for a **direct** hazard to the life and health of persons due to electrical voltage.

Non-observance of these symbols **causes** serious health problems up to life-endangering injuries.



This symbol stands for a **potential** hazard to the life and health of persons.

Non-observance of these symbols **can** cause serious health problems up to life-endangering injuries.



This symbol indicates a potentially hazardous situation.

Non-observance of these notes can cause minor injuries or damage to property.



This symbol indicates important information.

3 Safety

3.3 Responsibility of the operator

The operator is responsible for authorising only qualified personnel to work on the centrifuge (see chapter 3.4 - "Requirements concerning the personnel").

The areas of responsibility of the personnel concerning the operation, maintenance, and care of the unit must be clearly defined.

The safety-conscious work of the personnel in compliance with the operating manual and the relevant EC and national health and safety regulations as well as with the accident prevention regulations must be checked at regular intervals (e.g. every month).

Under the international rules for health and safety at work, the operator is obliged to:

- take measures in order to prevent all danger to life or health during work.
- ensure that centrifuges are operated properly and entirely as intended (see chapter 1.3 - "Intended use").
- take protective measures against fire and explosion when working with hazardous substances.
- take measures for the safe opening of centrifuges.

The operator must perform a risk assessment concerning potential accidents in connection with the centrifuge and take design-related countermeasures, if necessary.

The centrifuge has to be maintained regularly (see chapter 8 - "Maintenance and service").

Components that are not in a perfect state must be replaced immediately.

3.4 Requirements concerning the personnel



DANGER

Risk of injury if the personnel are not sufficiently qualified

If unqualified personnel perform work on the centrifuge or are present in the danger zone of the centrifuge, hazards result that can cause serious injuries and considerable damage to property.

- Ensure that all the tasks are performed by personnel with the corresponding qualifications.
- Ensure that unqualified personnel stay clear of the danger zones.



DANGER

Risk of fatal injury to unauthorised persons due to hazards in the danger zone or work area

Unauthorised persons who do not fulfil the requirements described herein are not aware of the hazards in the work area. This is why there is a risk of serious or even fatal injuries for unauthorised persons.

- Ensure that unauthorised persons stay clear of the danger zone and work area.
- If in doubt, address these persons and instruct them to leave the danger zone and work area.
- Interrupt any running work if unauthorised persons are present in the danger zone or work area.

This manual uses the following personnel qualifications for various areas of activity:

Qualified electrician

Due to their special training, knowledge, experience and familiarity with the relevant standards and regulations, qualified electricians are in the position to perform work on electrical systems and to autonomously identify and prevent possible hazards.

Qualified electricians have been specifically trained for the environment in which they work and they are familiar with all the relevant standards and regulations.

Qualified electricians must fulfil the requirements as set out in the applicable legal provisions concerning the prevention of accidents.

Specialised personnel

Due to their special training, knowledge, experience and familiarity with the relevant regulations, specialised personnel are in the position to perform any tasks assigned to them and to autonomously identify and prevent possible hazards.

Operating personnel

Only trained, specialised personnel are authorised to operate the unit. The persons operating the unit must

- be familiar with the fundamental health, safety, and accident prevention regulations,
- have read and understood this operating manual, in particular the safety sections and warning notes, and confirmed this with their signature,
- have been instructed in the operation and maintenance of this centrifuge.

3 Safety

3.5 Informal safety instructions

- This operating manual is a part of the product.
- The operating manual must be kept at the location of use of the centrifuge. Ensure that it is accessible at all times.
- The operating manual must be handed over to any subsequent owner or operator of the centrifuge.
- Any changes, additions or updates received must be added to the operating manual.
- In addition to the operating manual, the general and local rules and regulations concerning the prevention of accidents and the protection of the environment must also be supplied.
- Safety and danger indications on the centrifuge must be kept readable at all times. If necessary, they must be replaced.

3.6 Safety instructions

3.6.1 Electrical safety

As protection against electric shock, the centrifuge is equipped with an earthed mains power cable and connector. To ensure the effectiveness of this safety feature, the following must be ensured:



DANGER

- Ensure that the wall socket is properly wired and grounded.
- Check that the mains voltage agrees with the nominal voltage listed on the name plate.
- Ensure that the mains power cable is intact prior to using the centrifuge. Damaged or faulty mains power cables must be replaced immediately.
- Do not place vessels containing liquid on the centrifuge lid or within the safety distance of 30 cm around the centrifuge. Spilled liquids may get into the centrifuge and damage electrical or mechanical components.
- Only qualified and specialised personnel are authorised to perform service tasks or repairs of the electrical system for which the housing needs to be removed.
- Inspect the electrical equipment of the unit regularly. Defects such as loose or burnt cables must be eliminated immediately.
- Following the completion of any type of repair or service, the qualified and specialised personnel must perform final inspection and testing in compliance with the relevant standards.

3.6.2 Mechanical safety

In order to ensure the safe operation of the centrifuge, observe the following:



WARNING

- Do not open the lid when the rotor is in motion!
- Do not reach into the rotor chamber when the rotor is in motion!
- Do not use the centrifuge if it was installed incorrectly.
- Do not use the centrifuge without panels.
- Do not use the centrifuge if the rotors and inserts show signs of corrosion or other defects.
- Only use the centrifuge with rotors and accessories that have been approved by the manufacturer. In case of doubt, contact the manufacturer (see chapter 7.3 - "Service contact").
- Do not hold your fingers between the lid and the housing when closing the lid. Risk of crushing!
- Defective lid relieving devices could cause the centrifuge lid to fall (contact the service department, if necessary). Risk of crushing!
- Do not hit or move the centrifuge during its operation.
- Do not lean against or rest on the centrifuge during its operation.

3 Safety



WARNING

- Do not spin any substances that could damage the material of the rotors and buckets of the centrifuge in any way. Highly corrosive substances, for example, damage the material and affect the mechanical strength of the rotors and buckets.
- Stop the centrifuge immediately in the event of a malfunction. Eliminate the malfunction (see chapter 7 - "Malfunctions and error correction") or inform the service department of the manufacturer (see chapter 7.3 - "Service contact").
- Ensure that all repairs are performed only by authorised and specialised personnel.
- Prior to any start-up, check the centrifuge, rotor, and accessories for signs of damage that can be discerned from the outside. Special attention must be paid to all of the rubber parts (e.g. motor cover, lid seal, and adapters) in terms of visible structural changes. Defective parts must be replaced immediately.
- Open the centrifuge when it is not in use so that moisture can evaporate.

3.6.3 Fire prevention



DANGER

- Do not spin explosive or inflammable substances.
- Do not use the centrifuge within hazardous locations.

3.6.4 Chemical and biological safety

If pathogenic, toxic, or radioactive samples are intended to be used in the centrifuge, it is in the responsibility of the user to ensure that all necessary safety regulations, guidelines, precautions, and practices are adhered to accordingly.



DANGER

- Infectious, toxic, pathogenic, and radioactive substances may only be used in special, certified containment systems with a bio-seal in order to prevent the material from being released.
- Take suitable precautions for your own safety if there is a risk of toxic, radioactive, or pathogenic contamination
- Materials that chemically react with each other with a high level of energy are prohibited.



WARNING

- Keep informed about local measures to avoid harmful emissions (depending on the substances to be centrifuged).
- Protective clothing is not required for the operation of the centrifuge. The materials to be centrifuged may, however, require special safety measures (e.g. centrifugation of infectious, toxic, radioactive, or pathogenic substances).

3.6.5 Safety instructions for centrifugation

For safe operation, observe the following before starting the centrifuge:



WARNING

- Ensure that the centrifuge was set up properly (see chapter 5 - "Set-up and connection").
- Keep a safety range of at least 30 cm free around the centrifuge as well as with regard to walls and other devices.
- Do not store any dangerous goods in the centrifuge area.
- Do not stay in the safety area longer than what is absolutely necessary for the operation of the centrifuge.
- Only use the centrifuge with rotors and accessories that have been approved by the manufacturer. We explicitly warn against the use of equipment of poor quality. Breaking glass or bursting vessels can cause dangerous imbalances at high speeds.
- Ensure that the rotor and buckets are correctly fitted (see chapter 6.2.2.1 - "Installation of a rotor").
- Observe the instructions on the installation of accessories (see chapter 6.2.2.3 - "Installation of accessories").
- The rotor must be loaded in a rotationally symmetrical manner at equal weights.
- If liquids with a density $> 1.2 \text{ g/cm}^3$ are used, reduce the speed (see chapter 2.2.2.2 - "Density").
- Do not use the centrifuge if the rotor is loaded asymmetrically.
- Do not use the centrifuge with tubes that are excessively long.

3.6.6 Resistance of plastics

Chemical influences have a strong effect on the polymeric chains of plastics, and, therefore, on their physical properties. Plastic parts can be damaged if solvents, acids, or alkaline solutions are used.



NOTE

- Refer to the resistance data (see chapter 11.5 - "Resistance data")!

3 Safety

3.6.7 Rotors and accessories

3.6.7.1 Lifting and carrying rotors



All swing-out rotors applicable for this centrifuge and the angle rotor 12510 weigh more than 18 kg.

- Always lift the rotors with a lifting device or with a sufficient number of people helping you.

3.6.7.2 Service life of rotors and accessories

The rotors and accessories have a limited service life.



- Perform regular checks (at least once per month) for safety reasons!
- Pay special attention to changes, such as corrosion, cracks, material abrasion, etc.

- After 10 years, they must be inspected by the manufacturer.
- After 50,000 cycles, the rotor must be scrapped for reasons of safety.
- If other data concerning the service life are engraved on the rotor or bucket, these data shall apply accordingly. For example, a bucket with the engraving "max. cycles = 10,000" has a service life of 10,000 cycles, and a rotor with the engraving "Exp. date 01/27" must be scrapped in January 2027 at the latest (see figure).
- If a specification concerning the maximum number of cycles **and** a specification concerning the service life (i.e. a date) are provided, the specification that occurs first shall apply.

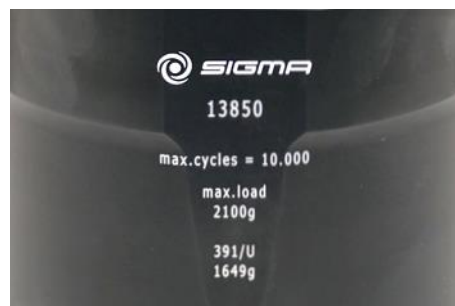

Fig. 7: Different service life – engraving on the bucket/rotor



- Refer to the table of the service life of rotors and accessories (see chapter 11.4 - " Table of the service life of rotors and accessories ")!

3.6.8 Safety of rotors and accessories

3.6.8.1 Marking

Batch number and serial number

During production, every rotor and bucket receives a batch number enabling conclusions to be drawn concerning the production process and the subsequent quality inspection.

Some rotors also have an additional serial number providing further detailed information.

The batch number and serial number is engraved on the rotor as follows:

- 1 Batch number
- 2 Serial number



Fig. 8: Rotor with an engraved batch number and serial number (example)



If there are any enquiries concerning the rotor, please state the batch number and serial number!

3 Safety

Set number and bucket number

Buckets are always produced in sets for a specific rotor. The set number is engraved on the bucket.

In addition, every bucket is assigned a fixed position in the rotor by way of a bucket number. The bucket number is engraved on the bucket and also on the rotor (see the following picture).

- 3 Bucket number
- 4 Set number



Fig. 9: The bucket number and set number on the bucket and the bucket number on the rotor

- Always install the buckets in their intended positions and align the inscription on the buckets in the same direction for all positions (inwards or outwards).

3.7 Safety devices

3.7.1 Lid lock device

The centrifuge can only be started when the lid is properly closed. The electrical lock must be locked. The lid can only be opened when the rotor has stopped. If the lid is opened by way of the emergency release system during operation, the centrifuge will immediately switch off and decelerate brakeless. If the lid is open, the drive is completely separated from the mains power supply, i.e. the centrifuge cannot be started (see chapter 7.1.1 - "Emergency lid release").

3.7.2 Standstill monitoring system

Opening of the centrifuge lid is only possible if the rotor is at a standstill. This standstill is checked by the microprocessor.

3.7.3 System check

An internal system check monitors the data transfer and sensor signals with regard to plausibility. Errors are detected with extreme sensitivity and displayed as error messages in a dialog box (see chapter 7.2 - "Table of error codes").

3.7.4 Earth conductor check

An earth conductor check can be carried out by authorised and specialised personnel using a suitable measuring instrument. Please contact the Sigma service department (see chapter 7.3 - "Service contact").

3.7.5 Imbalance monitoring system

A dialog box may pop up or emit a sound signal in order to indicate that the centrifuge is in the inadmissible imbalance range. If the rotor is loaded unevenly, the drive will be switched off in the acceleration phase or during the run.

3.7.6 Temperature monitoring system

If the temperature inside the rotor chamber rises above +50°C, the drive system will be switched off automatically. The centrifuge cannot be restarted until it has cooled.

3.7.7 Rotor monitoring system

When a rotor number and, if applicable, a bucket number are selected, the computer will automatically check whether the entered speed or the entered gravitational field are permissible for the selected rotor.

3 Safety

3.8 Measures in the event of hazards and accidents



DANGER

- If an emergency arises, switch off the centrifuge immediately!
- If in doubt, call the emergency doctor!

3.9 Remaining hazards

The centrifuge was built in accordance with the state of the art and in compliance with the generally recognized safety rules. However, danger to life and limb of the operator, or of third parties, or impairments of the unit or other material assets cannot be completely excluded when the unit is being used.

- Use the unit only for the purpose that it was originally intended for (see chapter 1.3 - "Intended use").
- Use the unit only if it is in a perfect running state.
- Immediately eliminate any problems that can affect safety.

4 Storage and transport

4.1 Storage conditions

The centrifuge can be stored in its original packaging for up to a year.

- Store the centrifuge only in dry rooms.
- The permissible storage temperature is between -20°C and +60°C.
- If you would like to store it for more than one year, or if you intend to ship it overseas, please contact the manufacturer.

4.2 Transport

The centrifuge must be transported by authorised specialised personnel. All the information concerning the transport is documented in a separate transport and installation manual.



- Comply with the information given in the separate transport and installation manual of the centrifuge!
- Ensure that any tasks concerning this field are only performed by authorised specialised personnel!

5 Set-up and connection

5 Set-up and connection

The centrifuge must be set up and connected by authorised specialised personnel. All the relevant information is documented in a separate transport and installation manual.



- Comply with the information given in the separate transport and installation manual of the centrifuge!
- Ensure that any tasks concerning this field are only performed by authorised specialised personnel!

5.1 Condensate drain

The condensate drain is used to drain the condensate off that forms in the rotor chamber during the centrifugation. It consists of a hose with a plastic valve. It consists of a hose with a plastic valve and runs from the rotor chamber to the outlet on the left side in the front door of the centrifuge (see chapter 2.1.1 - "Functional and operating elements").



WARNING

- Do not open the condensate drain unless the rotor is at a complete standstill.

Draining the condensate off

- Switch off the centrifuge at the mains switch and unplug the mains power plug.
- Connect the supplied hose connector and drain the condensate.
- Disconnect the hose connector by pressing the unlocking button.

5.2 Cover holder

The cover of the swing-out rotor 11805 with a windshield can be placed in the lid of the centrifuge when loading or unloading the centrifuge. In addition, it is possible to install a cover holder on the right side of the centrifuge. The required accessories are included in the scope of supply:

- 1 Holder for the rotor cover
- 2 Hexagon socket head screw (M6x16)

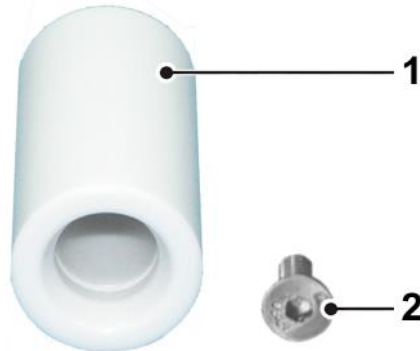

Fig. 10: Cover holder accessories

Installation

There is a hole for the cover holder in the middle of the upper edge on the right-hand side of the centrifuge.

- Insert the hexagon socket head screw through the hole of the cover holder and fasten the cover holder to the hole on the right-hand side of the centrifuge by way of the hexagon socket key (included in the scope of supply).

- 3 Holder in the centrifuge lid
- 4 External holder



Fig. 11: Storage options for the windshield cover

6 Using the centrifuge

6 Using the centrifuge

6.1 Initial start-up



DANGER

- Before the initial start-up, please ensure that your centrifuge is properly set up and installed (see chapter 5 - "Set-up and connection").

6.2 Switching the centrifuge on

- Press the mains power switch.

The display then illuminates. The centrifuge is ready for operation.

6.2.1 Opening and closing the lid

The lid can be opened if the centrifuge is at a standstill and if the lid key is illuminated.

- Press the lid key in order to open the lid.

The centrifuge cannot be started if the lid is opened.

- To close, press with both hands slightly on the lid until both locks are audibly locked.



WARNING

Do not place your fingers between the lid and the housing when closing the lid. Risk of crushing!

6.2.2 Installation of rotors and accessories

WARNING

All swing-out rotors applicable for this centrifuge and the angle rotor 12510 weigh more than 18 kg.

- Always lift the rotors with a lifting device or with a sufficient number of people helping you.

6.2.2.1 Installation of a rotor

- Open the centrifuge lid by pressing the lid key.

- 1 Fastening stud with a hexagon socket
- 2 Cone

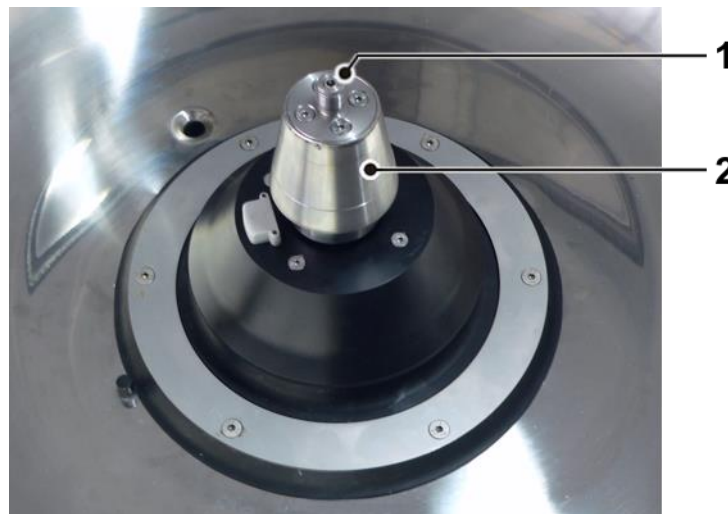

Fig. 12: Motor shaft

- Position the rotor carefully perpendicularly from above on the cone of the motor shaft (see the illustration above, item 2).

CAUTION

If the rotor gets jammed or if it is lowered too quickly onto the fastening stud, the thread of the stud may be damaged. In this case, it is no longer possible to correctly secure the rotor in place.

- Insert the supplied hexagon key (part no. 930 050) into the hexagon socket of the fastening stud of the motor shaft and hold it in place with two fingers ("two-finger-principle", see the following picture). At the same time, position the rotor wrench AF 17/19 (part no. 930 018) against the flat sides of the rotor hub and turn the hub clockwise until it is no longer possible to hold the hexagon key with two fingers.

6 Using the centrifuge

- 3 Hexagon key
- 4 Rotor wrench



Fig. 13: "Two-finger-principle" for holding the hexagon key

- Release the hexagon key, hold the rotor in place with one hand (see the following picture) and tighten it with the aid of the rotor wrench and a tightening torque of 20 Nm.



Fig. 14: Fastening of the rotor



WARNING

After frequent use, the rotor tie-down screw must be loosened by some turns, the rotor has to be lifted and fastened again. This must be done once a day or after 20 cycles. This ensures a proper connection between the rotor and the motor shaft.

- Follow the safety instructions and hazard warnings (see chapter 3 - "Safety")!

Removing the rotor

The removal of the rotor is performed in reverse order. When loosening the rotor with the aid of the rotor wrench, it may be necessary to overcome a certain resistance. Do not apply the hexagon key until the rotor has been loosened with the rotor wrench to such an extent that the rotor hub turns together with the rotor and the "two-finger-principle" can be applied.



The rotor installation and removal is shown in a video:

**6.2.2.2 Installation of an angle rotor with a hermetic lid**

- Slightly grease the rotor and lid seals after cleaning.

- Screw the lid onto the rotor and tighten it clockwise by hand.
- Install the rotor as described under chapter 6.2.2.1 - "Installation of a rotor".
- If necessary, the rotor can be removed without opening the lid after the rotor fastening has been loosened.
- To loosen the rotor lid, insert the tool (part no. 17985) supplied together with the lid into the openings in the lid that are intended for this purpose and open the lid by turning anti-clockwise.
- Follow the safety instructions and hazard warnings (see chapter 3 - "Safety")!



WARNING

The lid screw serves for the fastening of the lid onto the rotor only, not for the fastening of the rotor onto the motor shaft!



The rotor can also be used without a lid.

6 Using the centrifuge

6.2.2.3 Installation of accessories

- Only use vessels that are suitable for the rotor.
- In the case of swing-out rotors, all of the compartments must be equipped with buckets.
- Always load rotationally symmetrical compartments of the rotors with the same accessories and fill to avoid imbalance.

Centrifugation with vessels of various sizes

Working with vessel of various sizes is possible. In this case, however, it is very important that the rotationally symmetrical inserts are identical.

correct



incorrect

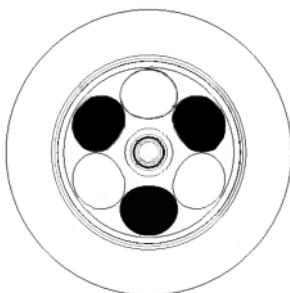

Fig. 15: Permissible and impermissible loading of a swing-out rotor with vessels of various sizes (example illustration)

Centrifugation with low capacity

- Install the sample vessels in a rotationally symmetrical manner so that the buckets and their suspensions are loaded evenly.
- It is not permissible to load angle rotors on only one axis.

correct



incorrect

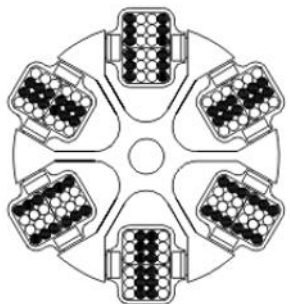
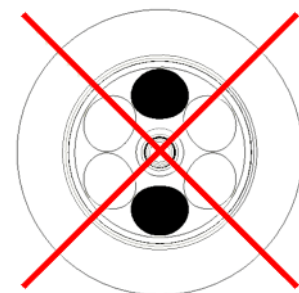

Fig. 16: Permissible and impermissible loading of an angle rotor and a swing-out rotor (example illustration)

6 Using the centrifuge



Pay attention to the marking of the centrifuge (see the illustration below)! Safety indications on the centrifuge must be kept readable at all times. If necessary, they must be replaced.

Rotor:

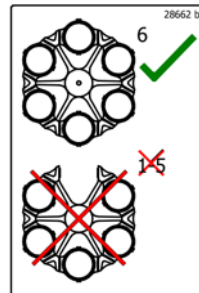

Bucket:

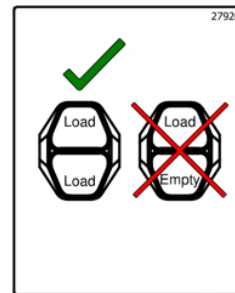

Fig. 17: Safety indication on the centrifuge

6.2.2.4 Adapters

In order to ensure easy handling, even if vessels of various sizes are used, carrier systems were developed.

- Load the opposite adapters with the same number of vessels and with the same weights in order to avoid imbalance.
- If all of the compartments of a carrier are not used, the buckets must be loaded evenly. Loading the edges of a bucket only is not permissible.

6.2.2.5 Vessels

- Load the tubes outside of the centrifuge. Liquids in the buckets or multiple carriers cause corrosion.
- Fill the vessels carefully and arrange them according to their weight. Imbalances result in the excessive wear of the bearings.
- Always fill the tubes up to their useful volume (= the volume that is stated for the tube).
- After the centrifugation, remove the vessels carefully in order to prevent the samples from mixing.
- Follow the safety instructions and hazard warnings (see chapter 3 - "Safety")!

6 Using the centrifuge

Maximum speed for tubes

Some tubes, such as centrifuge glass tubes, microtubes, culture tubes, fluoropolymer tubes and especially high-volume tubes can be used in our rotors, buckets, and adapters at higher speeds than their breaking limit.



When using glass vessels, the maximum value of 4,000 x g must not be exceeded (except special high-strength glass tubes; please refer to the information provided by the manufacturer).



When installing the 500 ml bottles use the supplied supporting rings.



At speeds above 8,000 rpm, there is an increased risk of breakage, in particular for 250 and 500 ml bottles!

6.2.2.6 Blood bag systems

- All six places on the rotor must be loaded with buckets.
- It is required to fill just two opposite buckets must be filled with one adapter for blood bags and two blood bag systems each.
- The opposite buckets, including the filled blood bag systems, must have an equal weight. If the number of blood bags is uneven, a balance adapter must be used. For taring, several balance weights are available.
- The blood bags must be put into opposite buckets in a mirror-inverted way (see figure).
- In both adapter compartments, the main blood bag must be situated towards the middle. The opposite bucket must be loaded correspondingly (see figure, item 1).
- When using smaller bag systems or in the case of incompletely filled blood bags, adapters (e.g. part no. 17750) must be inserted together with the blood bag systems. This will help to avoid any slipping of the bags, which could result in an imbalance.

6 Using the centrifuge

- 1 Proper loading
- 2 Possible loading
- 3 Improper loading

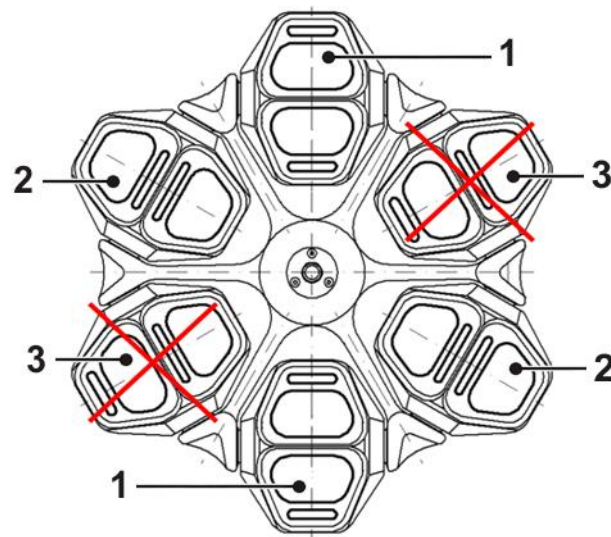

Fig. 18: Loading of blood bag systems



WARNING

The service life of the adapter for blood bags no. 13867 is limited. Refer to the table of rotors and accessories with a different service life (see chapter 11.4 - " Table of the service life of rotors and accessories ")!



At maximum speed, the plastic adapter 13867 must not be used at a temperature above 25°C. If it is used at a considerably lower speed (up to 2,500 rpm), the temperature can be higher than 25°C.

6 Using the centrifuge

6.3 Control system "Spincontrol S"

6.3.1 User interface

The centrifuge is operated via three buttons with integrated light-emitting diodes and one function knob. The display is divided into several different fields. The various functions of the system can be called up by pressing and turning the function knob.

- 1 Start button
- 2 Display
- 3 Function knob
- 4 Stop button
- 5 Lid button



Fig. 19: User interface of the Spincontrol S control system

Display

The centrifuge display has the following fields:

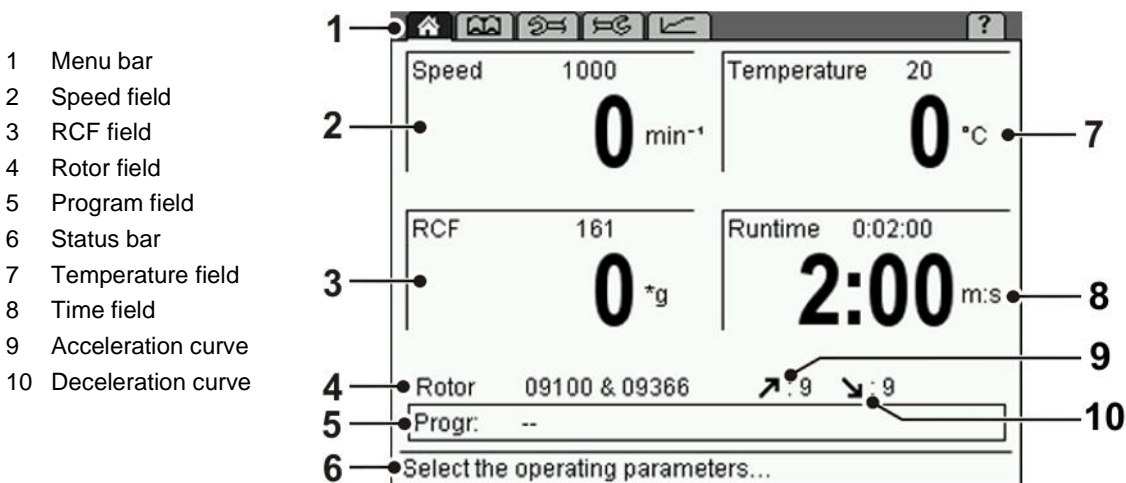

Fig. 20: Display of the Spincontrol S control system

6.3.2 Manual mode

6.3.2.1 Starting a centrifugation run

The centrifuge is ready for operation when the start key is illuminated.

- Press the start key in order to start a centrifugation run.

6.3.2.2 Interrupting a centrifugation run

- Press the stop key in order to interrupt a centrifugation run. The centrifugation run will be terminated prematurely.

Quick stop

- Press the stop key for more than three seconds.

The centrifuge decelerates with the maximum deceleration curve.

After a quick stop, the centrifuge lid must be opened before a new centrifugation run can be started.

A quick stop can also be triggered during a normal deceleration, e.g. in order to speed up the deceleration.

When a quick stop is triggered, "Quick stop" will be displayed in the speed field.



A quick stop can be performed even if the centrifuge is blocked against unauthorised use.

6.3.2.3 Interrupting a deceleration process

- Press the start key during a deceleration process in order to interrupt it and to restart the centrifuge.

6.3.2.4 Selection, display, and modification of data

The "Standard" menu is displayed.

- Turn the function knob in order to select a field. The selected field is inverted.
- Press the function knob. The display starts to flash and the modification mode is active.
- Turn the function knob in order to modify the set value of the selected field.
- Press the function knob again to confirm the entry and to quit the modification mode.

6 Using the centrifuge

6.3.2.5 Standard menu

The "Standard" menu is symbolised by the icon "🏠" on the menu bar and it is displayed a few seconds after the centrifuge has been switched on. In this menu, the parameters of a centrifugation run can be displayed and modified.

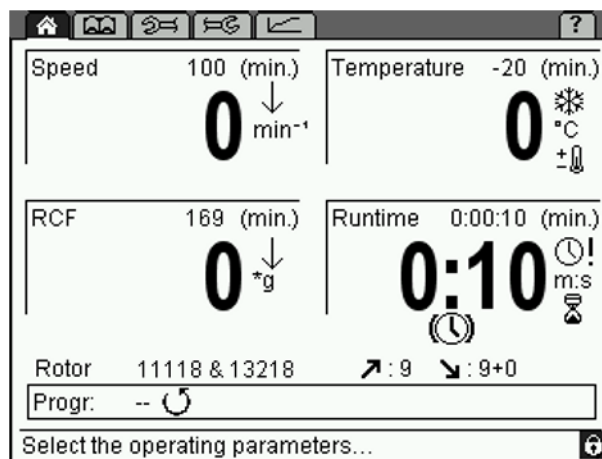

Fig. 21: Standard menu; here shown with all of the possible symbols

Speed

In the upper section of the field, the set speed of the centrifuge is displayed. The actual speed is displayed below this value. The values are stated in revolutions per minute ($\text{min}^{-1} = \text{rpm}$) and depend on the RCF values (see chapter 2.2.2.1 - "Speed, radius, and relative centrifugal force"). The maximum speed values depend on the rotor that is used.

Relative centrifugal force (RCF)

The relative centrifugal force is the acceleration that the sample is subjected to during the centrifugation run. The set value of this parameter is displayed in the upper section of this field, with the actual value shown below. The values are stated in g (gravitational acceleration) and they depend on the speed values (see chapter 2.2.2.1 - "Speed, radius, and relative centrifugal force"). The maximum RCF values depend on the rotor that is used.

Temperature



The set temperature is displayed in the upper section of the field, with the current sample temperature shown below. Temperatures between -20 °C and $+40\text{ °C}$ can be preselected.



The centrifuge is not equipped with an active heater. As a result, temperatures above room temperature depend on the air friction of the running motor.

Runtime

The set runtime is displayed in the upper section of this field, with the remaining runtime shown below. The runtime is defined as the period from the start of the centrifuge to the beginning of the deceleration phase. The maximum value is 99 h 59 min 59 sec.

In the "Setup" menu , it can be specified that the runtime is not to be started until the set speed is reached (see chapter 6.3.2.8 - "Setup menu"). In this case, the symbol "!" appears in the runtime field.

Continuous run

During the continuous run, the runtime of the centrifuge is unlimited and must be stopped manually. The centrifuge accelerates during the continuous run until the set speed is reached.

- Select the field "Runtime" and confirm the selection. The display flashes when it is activated.
- Turn the function knob from the time 0:00:10 anti-clockwise or from the time 99:59:59 clockwise. "Infinite" will be displayed. After the start of the centrifuge, the elapsed time will be displayed.
- Deactivate the continuous run by pressing the stop button or by entering a specific runtime.

Short run

A short run can be started if no run is active.

- Keep the start button pressed during the short run.

During the short run, the centrifuge accelerates with acceleration curve 9 (maximum acceleration) until the maximum speed of the rotor is reached. The runtime is counted and in the speed field the message "Short run" flashes.

When the start button is released, the centrifuge decelerates with the maximum deceleration curve to a standstill.



The parameters speed, RCF, temperature, and runtime can be changed during the centrifugation.



If the centrifuge is locked with level 02 or higher, it is not possible to start a short run.

6 Using the centrifuge

Rotor: rotor selection list

This field shows the rotor that is currently being used.

- Select the field "Rotor" and confirm the selection. A list with all of the possible rotors without buckets is displayed.
- Select the desired rotor.
 - If an angle rotor is selected, additional information concerning this rotor will be displayed.
 - In the case of swing-out rotors, a list with all of the possible rotor/bucket combinations will be displayed. Select an item from the list so that the additional information concerning the combination will be displayed.
- Press the function knob in order to accept the data.

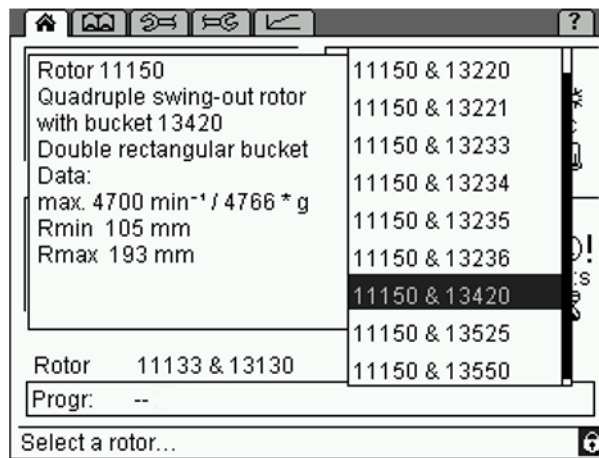

Fig. 22: Rotor selection list, here with potential rotor-bucket combinations and additional information

Automatic rotor identification

The centrifuge automatically identifies the rotor that is currently being used.

- If the system identifies a different rotor than the one that is set and if there are no different buckets for this rotor, the rotor input will be adapted automatically. The system will not display a message.
- If the system identifies a different rotor than the one that is set, and if there are different rotor/bucket combinations for this rotor, the system will automatically identify the correct rotor and select the rotor/bucket combination with the lowest speed. The system will display a corresponding message so that the combination can be adapted manually.
- If the system cannot identify the rotor, a message will be displayed. The rotor cannot be used in the centrifuge.

This prevents the maximum permissible speed from being exceeded.

Acceleration ↗

This function is used to select an acceleration curve. One can select a linear rise (curves 0-9) or a quadratic rise (curves 10-19). The acceleration curves 20-29 can be programmed as desired (see chapter 11.3 - "Acceleration and deceleration curves").

Deceleration (brake) ↘

This function is used to select a curve that decelerates the centrifuge to a standstill. Deceleration curves are inverted images of the acceleration curves and are labelled with identical numbers. Deceleration curve no. 0 represents a brakeless deceleration.

Progr.: program list

This field in the "Standard" menu shows the program that is currently loaded. When the field is selected, the program list is displayed (for information on how to work with the programs, please see chapter 6.3.3 - "Program mode").

The program "RAPID_TEMP" (see below) cannot be deleted.

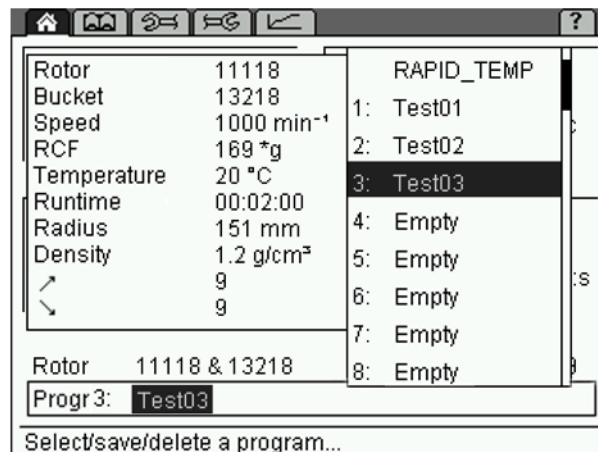



Fig. 23: Program list

Program "RAPID_TEMP"

Precooling or preheating at a standstill may distort the measurement results and cause the increased wear of the mechanical components. This is why the centrifuge has a special program that precools or preheats the rotor chamber rapidly to a preset value under defined conditions.

- Select the option "Progr" in the "Standard" menu  and confirm the selection. The program list will be displayed.
- Select the program "RAPID_TEMP" on the program list and confirm the selection. The display shows $\frac{1}{3}$ of the maximum rotor speed and the corresponding RCF value. The deceleration (brake) and acceleration curves correspond to curve 9 and the runtime field indicates "infinite" (continuous run).

6 Using the centrifuge

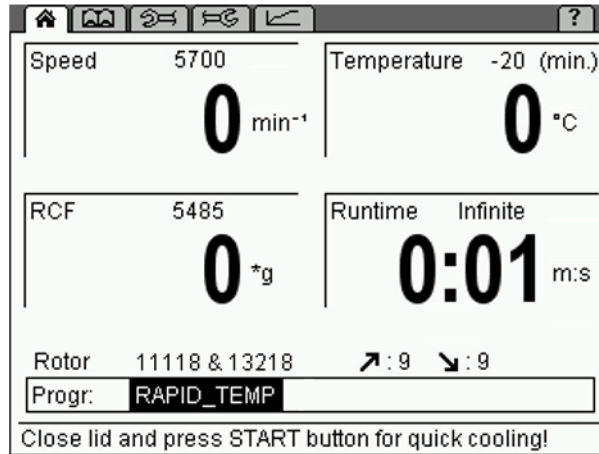

Fig. 24: Program "RAPID_TEMP"

i NOTE

The program will only be loaded if the actual temperature is above the set temperature.

- Press the start button in order to start the rapid cooling run.
- During the rapid cooling run, the set temperature can be modified within the range below the actual temperature.

The current status of the program will be displayed on the status bar.

The "RAPID_TEMP" program will be stopped under the following conditions:

- The set value is reached. In this case, the "RAPID_TEMP" program stops with a sound signal and the standstill cooling system will be activated.
- The stop button is pressed. The "RAPID_TEMP" program will be stopped prematurely. No message will be issued when the set temperature is reached.
- A parameter is changed (except for the temperature) or another input is made. In this case, the "RAPID_TEMP" program will be aborted. No message will be issued when the set temperature is reached.

After the stop, the previous program will be reloaded or the changed parameters will be adopted as the new settings.

i NOTE

The automatic lid opening function is suppressed after a rapid cooling run in order to prevent the system from reheating.

i NOTE

The delta T temperature monitoring system (see chapter 6.3.2.7 - "Parameters menu", Process) remains inactive as long as the "RAPID_TEMP" program is active.



If the "RAPID_TEMP" program is used, the temperature of the unloaded aluminium bucket will be displayed. If samples, which have not been precooled, are placed into the buckets, the displayed temperature will deviate from the actual sample temperature.

Progress indicator

The progress indicator provides a quick overview of the remaining runtime of the running centrifugation run. For this purpose, a green progress bar and percentage value are displayed in the program field.

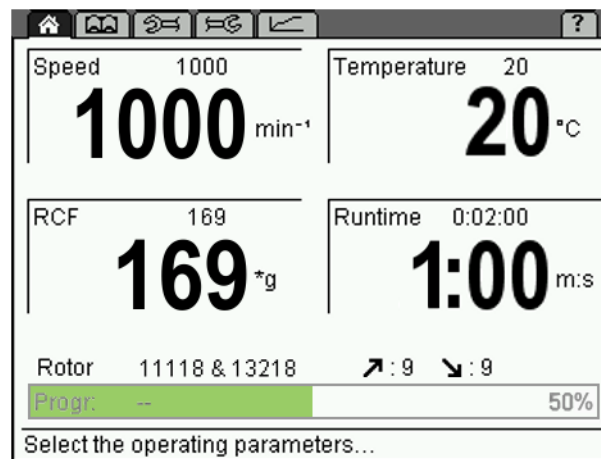

Fig. 25: Progress indicator during a centrifugation run

After the completion of the centrifugation run, the progress indicator remains at 100% until

- the lid is opened,
- a parameter is changed,
- a program is loaded, saved, or deleted, or
- a new centrifugation run is started.

6 Using the centrifuge

6.3.2.6 Process library menu

The process library can be opened via the "📖" symbol on the menu bar. It provides the user with an overview of all of the stored programs as processes.

The processes are listed with their name, RCF, runtime, and temperature (exception: the "RAPID_TEMP" program will not be listed).

The order of the processes corresponds to their storage locations on the program list. Empty storage locations will not be displayed. If more than 11 programs have been stored, the user can scroll through the list.

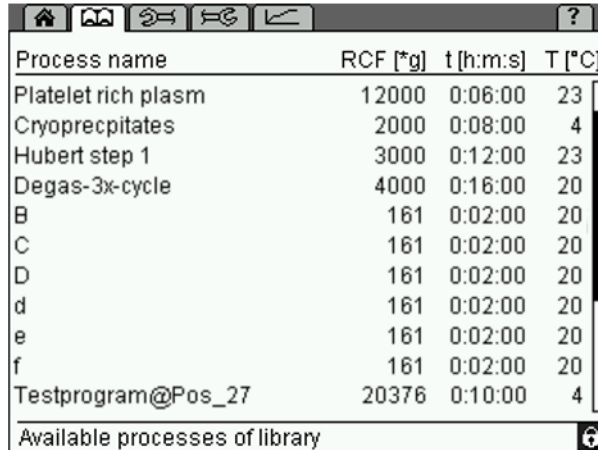

Process name	RCF [*g]	t [h:m:s]	T [°C]
Platelet rich plasm	12000	0:06:00	23
Cryoprecipitates	2000	0:08:00	4
Hubert step 1	3000	0:12:00	23
Degas-3x-cycle	4000	0:16:00	20
B	161	0:02:00	20
C	161	0:02:00	20
D	161	0:02:00	20
d	161	0:02:00	20
e	161	0:02:00	20
f	161	0:02:00	20
Testprogram@Pos_27	20376	0:10:00	4

Available processes of library

Fig. 26: Process library menu

Loading a process

- In the process library, select the desired process by turning the function knob. Press the function knob in order to confirm the selection.

The process will be loaded and the "Standard" menu 🏠 will be displayed.

Starting a process

- In the process library, select the desired process by turning the function knob. Then, press the start button.

The process will be loaded and started. The "Standard" menu 🏠 will be displayed.

6.3.2.7 Parameters menu

The "Parameters" menu is symbolised by the "⚙️" symbol on the menu bar. It is used to specify various conditions for the centrifugation. These conditions are used to monitor the process and to control access to the centrifuge.

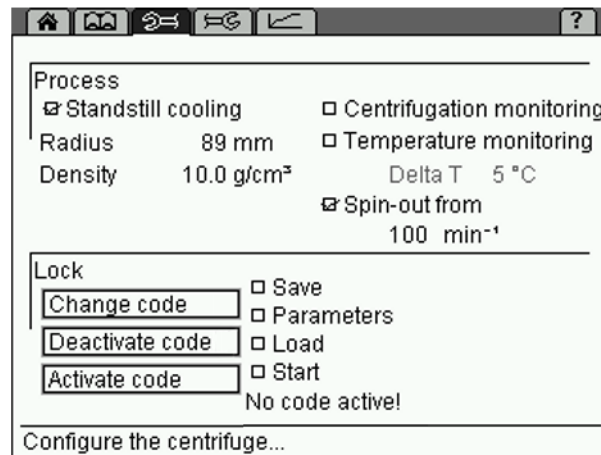

Fig. 27: Menu "Parameters"

Process
Standstill cooling

Depending on the substances to be centrifuged, it may make sense to precool the centrifuge. The precooling prevents the cooled samples in the uncooled centrifuge from heating up to an inadmissible temperature level.

If the standstill cooling function is activated, the centrifuge starts to precool after it is switched on. In the runtime field, the symbol "❄️" is displayed. The lid must be closed.

CAUTION

Unmoved air in the rotor chamber leads to an incorrect measuring and control behaviour and causes the compressor to freeze over. At temperatures below 0°C, aqueous liquids will freeze, thereby preventing sedimentation.

- Do not cool the rotor below 0°C at a standstill.

NOTE

The centrifuge is equipped with the "RAPID_TEMP" program. This program is used to precool the rotor chamber quickly under defined conditions (see chapter 6.3.2.5 - "Standard menu", Program list).

Radius

The radius determines the value of the relative centrifugal force (RCF) that the sample is subjected to. Normally, the maximum RCF value is displayed. If the value is reduced manually, a downward facing arrow "↓" will be displayed in the RCF field.

6 Using the centrifuge

Density

This setting is useful for glass vessels. If the density of the liquid to be centrifuged is higher than 1.2 g/cm³, the value must be adapted manually in order to prevent the glass vessel from breaking. This will reduce the maximum possible final speed (see chapter 2.2.2.2 - "Density"). The reduction will be represented by a downward facing arrow "↓" in the speed field. Values between 1.2 and 10.0 g/cm³ are possible.

Centrifugation monitoring

The centrifugation monitoring function enables the continuous monitoring of the speed and runtime parameters during the centrifugation.

- Activate the centrifugation monitoring function by clicking.



If the function is activated during a centrifugation run, the monitoring process will not be started until the start of the next centrifugation run.

The centrifugation monitoring function compares the speed values of the current run with the reference values that are stored in the control unit. After every run, it issues a corresponding message.

The runtime is considered faulty if the centrifugation run had to be stopped prematurely.

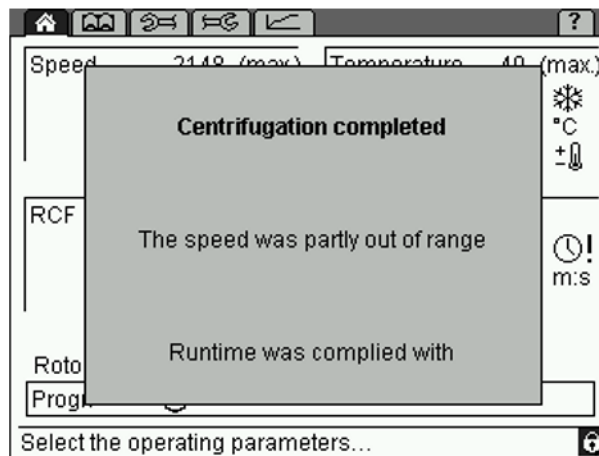

Fig. 28: Example of a centrifugation monitoring message



If the centrifugation monitoring system is used in combination with free acceleration or deceleration curves, unjustified error messages may result in certain cases.

6 Using the centrifuge

Temperature monitoring

The control system includes a temperature monitoring function. If the actual temperature difference with regard to the set value deviates from the set temperature difference, the centrifuge will stop and an error message will be issued.

- Activate the temperature monitoring function by clicking.
- Adjust the desired "Delta T" limit value in steps of 1°C or 1°F and confirm the setting.

If the temperature monitoring function is active, the symbol "±" is displayed in the temperature field of the "Standard" menu.

In this case, the centrifuge can only be started if the current temperature is between the preset temperature in the "Standard" menu and the "Delta T" limit value.

If the temperature leaves this range during the centrifugation run, an error message will be displayed and the centrifuge will be decelerated to a complete standstill.



The delta T temperature monitoring system remains inactive as long as the "RAPID_TEMP" program is active (see chapter 6.3.2.5 - "Standard menu", "Program "RAPID_TEMP"").

Spin-out from...

If this function is active, the brake will be deactivated when the actual speed is below the set speed. As a result, the rotor will spin out in a brakeless manner.



A spin-out, in particular with heavy rotors and at high speeds, can take a lot of time! (Depending on the rotor and load, the speed will be reduced by approximately 0.5 to 1 rpm per second.)

If the spin-out is active, "+0" is displayed next to the deceleration curve.

- The spin-out can be interrupted by a quick stop or by restarting the centrifuge.

6 Using the centrifuge

Lock

In order to prevent any unauthorised use of the centrifuge, the following functions can be blocked:

- Saving of programs (level 01)
- Changing of parameters, short run (level 02)
- Loading of programs (level 03)
- Start button (level 04)

Blocking a function

- Select the function that is to be blocked. The lower levels will also be automatically selected (if, for example, the "Parameters" function is selected, the "Save" function will also be selected).
- Select the button "Activate code".
- Enter a four-digit code and confirm the entry.

The lock is now active. The symbol "🔒" will be displayed in the status line and the lock level will be indicated.

If changes are made after a function has been blocked, the system will ask for the code prior to executing the change.

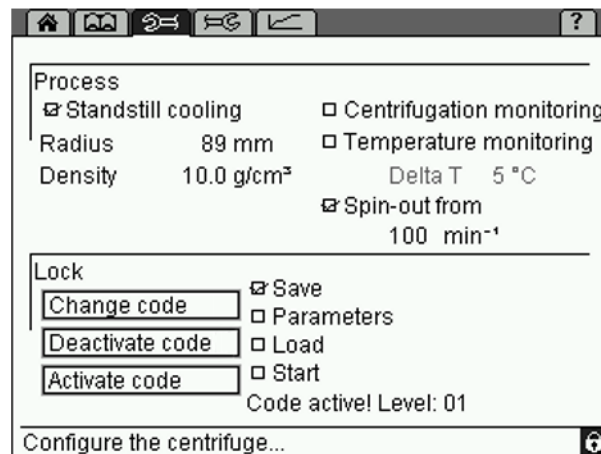

Fig. 29: "Parameters" menu with an active lock (level 01)

Unblocking a function

- Select the button "Deactivate code".
- Enter the code and confirm the entry.

The lock is now deactivated.

Changing the code

- Select the button "Change code".
- Enter the old code and confirm the entry.
- Enter the new code.
- For safety reasons, the code must be entered a second time.

The code is now changed.

6.3.2.8 Setup menu

The "Setup" menu is symbolised by the "⚙️" symbol on the menu bar. It is used to perform basic settings concerning the control system of the centrifuge. It enables the optimum adaptation of the centrifuge to its specific area of application.

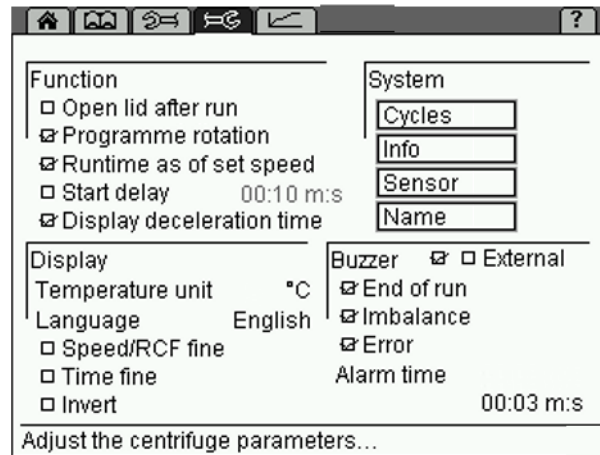

Fig. 30: Menu "Setup"

Function
Open lid after run

The automatic lid opening function ensures that the lid opens when the rotor has stopped.

CAUTION

When the lid is open, the cooling is not active. The sample may warm up!

Program rotation

See chapter 6.3.3.5 - "Automatic program rotation".

Runtime as of set speed

If this function is active, the runtime will not be measured until the set speed is reached. In the "Standard" menu, the symbol "⌚!" will be displayed in the runtime field.

NOTE

In the program mode, this function can be saved separately for every program. In this case, the symbol "⌚!" will be displayed under the runtime of the detailed program description.

6 Using the centrifuge

Start delay

If the start delay function is active, the centrifuge will not start until the preset time has elapsed. The symbol "⌚" will be displayed in the runtime field.

Display deceleration time

In the activated mode, the deceleration time will be displayed instead of the runtime during and after the deceleration process. Below the time display, the symbol "⏻" will be displayed. During a deceleration process, the symbol flashes. Once the deceleration is complete, it is displayed in a permanent manner.

Display

Temperature unit

The temperature can be displayed in °C (Celsius) or °F (Fahrenheit).

Language

The control system can be used in various language versions.

If a language is selected by mistake, it can be changed on any screen as follows:

- Press and hold the stop button.
- Turn the function knob one notch to the left and then one notch to the right.
- Release the stop button. The "Language" window will be displayed.
- Select the desired language.

Speed/RCF fine and Time fine

This menu item can be used to preselect the set speed in steps of 1 rpm (instead of 100 rpm), the RCF value in steps of 1 x g (instead of 10 x g), and the set time in steps of 1 min or 1 sec (instead of 10 min or 10 sec).



Regardless of the fine adjustment, the step size increases when the function knob is turned quickly.

Invert

If this function is activated, the display switches from the standard setting with a bright background and dark writing to a dark background with bright writing.

SystemCycles

This field shows the number of cycles as well as the runtime of the rotor and buckets that are used.

Info

This item provides information on the software versions that are used in this centrifuge.

Sensor

The sensor mode is reserved for the service personnel.



Values can neither be entered nor changed in the menus "Cycles", "Info", and "Sensor".

Name

In this field, an identification will be assigned to the centrifuge.

- The letters and characters can be entered when the cursor flashes in the text field. Turn the function knob in order to select a character and press it to confirm the selection. Then, press the knob again in order to enter the next character. Pressing the arrow button ← will delete the last character. The maximum number of characters is 19.
- When the name is complete, select the option "Accept" and confirm it.

Buzzer (signal)

With this function, a warning sound signal can be selected for

- the end of a centrifugation run,
- an imbalance message,
- an error message.

The duration of the warning signal can be specified.

External

This function is only available if the centrifuge is equipped with the option for the input and output of data (external signal, floating switch) (see chapter 6.3.4 - "Options for data input and output").

6 Using the centrifuge

6.3.2.9 Curve menu

This menu is used to create and edit customised acceleration and deceleration curves (see chapter 11.3 - "Acceleration and deceleration curves"). It is symbolised by the "⏏" symbol on the menu bar.

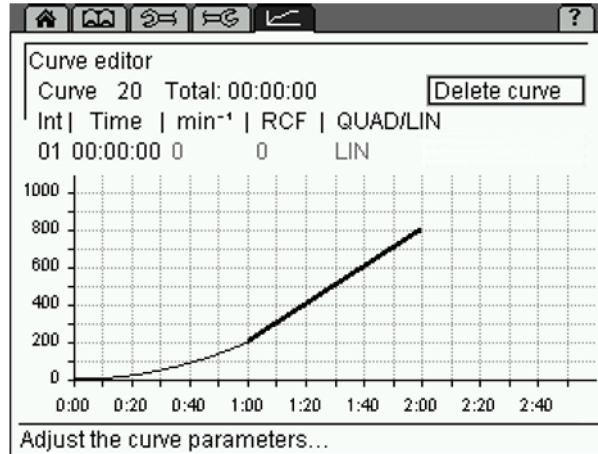

Fig. 31: Menu "Curve"

Creating or changing an acceleration curve



During a centrifugation run, curves can only be displayed. They cannot be changed or deleted.

- Select the "Curve" menu. The curve editor will be displayed.
- Select a curve number between 20 and 29 in the input field "Curve". If the curve number is already used, the stored curve will be displayed.
- The input field "Int" is used to specify the interval number of the process. Up to ten intervals can be entered for a curve.
- Enter the interval time of the current interval into the input field "Time". While doing so, certain restrictions must be taken into consideration (see below).
- Enter the desired acceleration under "min⁻¹" (rpm) or "RCF". While doing so, certain restrictions must be taken into consideration (see below). The values are interdependent.
- In the first interval, "QUAD/LIN" can be used to select a linear or quadratic rise. All of the other intervals are linear.

The field "Total" shows the total runtime of the process. The maximum total runtime of a curve depends on the slope of the curve and on the final speed of the rotor.



Only the last curve interval can be changed retroactively.

Restrictions

- Acceleration and deceleration curves can include intervals with a positive slope as well as intervals with a negative slope and also intervals with 0 slope.
- The slope of the curve intervals can be 1 min⁻¹/sec (rpm/sec) minimum and 1000 min⁻¹/sec (rpm/sec) maximum.
- Quadratic curve intervals are only possible between 0 and 1000 min⁻¹ (rpm) maximum. If a final speed > 1000 min⁻¹ (rpm) is selected, this interval will automatically become linear above 1000 min⁻¹ (rpm).
- The possible runtime results from the maximum possible speed (depending on the rotor) and from the slope limitation.

Example 1: Start speed 0 min⁻¹ (rpm), final speed 100 min⁻¹ (rpm), runtime 1 hour not possible, since the necessary slope < 0.03 min⁻¹ (rpm), which means that it is beyond the defined range.

Example 2: Start speed 0 min⁻¹ (rpm), final speed 15000 min⁻¹ (rpm), runtime 10 sec. not possible, since the necessary slope is 1500 min⁻¹ (rpm), which means that it is beyond the defined range.

6.3.2.10 Option: Barcode menu

In order to connect a barcode scanner, the centrifuge must be equipped with a second RS232 interface and a corresponding circuit board.

If the centrifuge is equipped with the barcode scanner function, the symbol "|||||" will be displayed on the menu bar. In order to use this function, a PC and a barcode scanner must be connected to the RS232 interface.

The "Barcode" menu shows all of the codes that are stored in the control system. Data structure 020 is displayed in the left-hand area of the screen, and data structure 001 is in the right-hand area. Free storage locations are symbolised by symbols without any code.

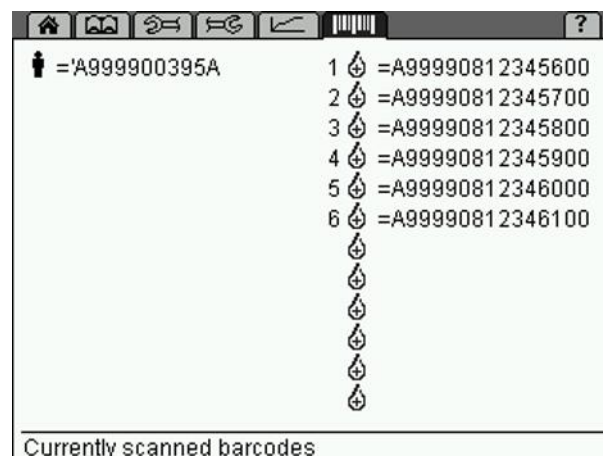

Fig. 32: Barcode menu

6 Using the centrifuge

With the barcode scanner, the barcodes can be scanned directly at the centrifuge during the loading process. The centrifugation data can be enquired cyclically (automatically) by the PC. Once a centrifugation run is complete, the PC can detect this and save the result (centrifugation data with barcodes).

Barcode commands

Setting a barcode: "setbarcode"

Every code must be set separately. This is done automatically by way of the scanner. Barcodes will only be accepted under the following conditions:

- There is no active centrifugation run.
- There are not any barcodes stored in the system which have already been used for a centrifugation run.
- The barcode does not already exist.
- It is an ISBT 128 barcode with the data structure 001 (donation identification number) and there are fewer than 12 of these codes stored in the system.
- It is an ISBT 128 barcode with the data structure 020 (staff member identification number) and there are not any barcodes with this data structure stored in the system.

If the barcode is accepted, the data of the last centrifugation run will be automatically deleted and the "Barcode" menu will be displayed.



In the event of a mains power failure, all the codes that have been scanned in so far will be lost and must be scanned again.

Reading out the stored barcodes: "getbarcodes"

All of the codes will be output in one response. This leads to the following possible response formats:

- No codes are stored
→ syntax "Barcodes none\r\n"
- Only codes with the data structure 001 are stored
→ syntax "Barcodes abc, def,...\r\n" (abc, def,... = barcodes)
- Only codes with the data structure 020 are stored
→ syntax "Barcodes abc (staff)\r\n" (abc = barcode)
- Codes with the data structures 001 and 020 are stored
→ syntax: "Barcodes abc (staff), def,...\r\n" (abc, def,... = barcodes)

6 Using the centrifuge

Deleting the stored barcodes: "deletebarcodes"

This command is used to delete all of the stored barcodes.
The "Barcode" menu will be updated.



This command will not be accepted unless the centrifuge is at a standstill.

Reading out the data of the last centrifugation run: "getlastrun"

The response to this command includes information concerning the parameters and status of the last centrifugation run (for the exact format of the data see chapter 11.6 - "Serial Control Interface Specification").

If barcodes have been stored, they will also be output as follows:

- Syntax data structure 001:
"Barcode;x;abc\r\n" (x = serial number starting at 1, abc = barcode)
- Syntax data structure 020:
"Barcode;Staff Member ID;abc\r\n" (abc = barcode)

The enquiry can be performed at any time (before, during, and after the centrifugation run). Depending on the time of the enquiry, some of the results may still be unknown.

6.3.2.11 Help menu

The help function is symbolised by the "?" symbol on the menu bar. It provides a short description of the control elements of the selected option.

Activating and deactivating the help function

- Select the question mark on the menu bar and press the function knob.
- Quit the help function by selecting the question mark and by pressing the function knob again.

Parameters can still be changed when the help function is activated.

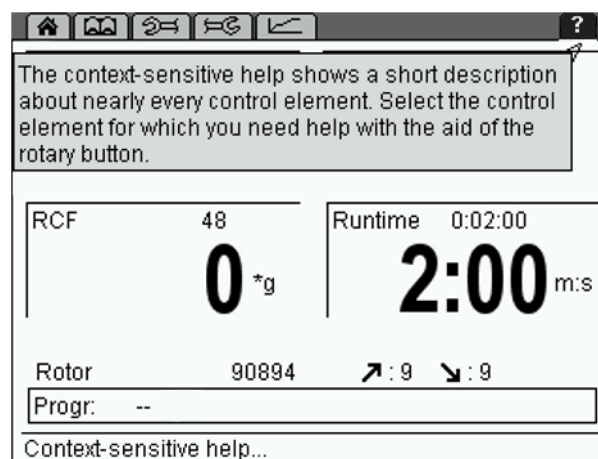

Fig. 33: Menu "Help"

6 Using the centrifuge

6.3.2.12 Changing the contrast

To change the contrast:

- Press and hold the stop button and turn the function knob one notch to the left. A dialog box will be displayed once the stop button is released.
- Adjust the contrast of the centrifuge display and confirm the change.

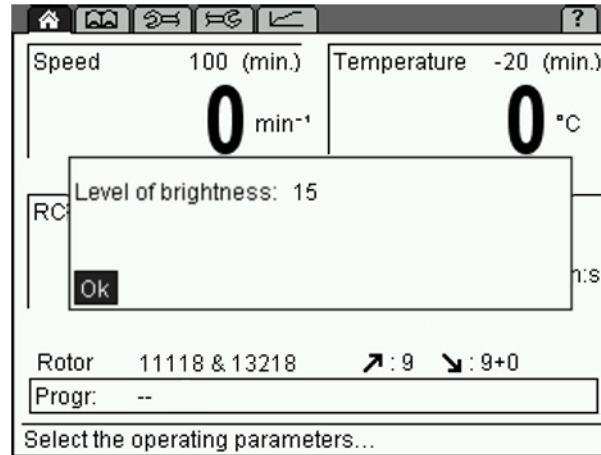

Fig. 34: Dialog box for changing the contrast

6.3.3 Program mode

A program contains all of the data that are required for a centrifuge run. Certain sedimentation results can be repeated under identical conditions. Programs can be loaded, executed, edited, and deleted when the centrifuge is at a standstill.

A maximum of 60 programs can be stored under the numbers 1-60. The program "RAPID_TEMP" does not occupy any storage location and cannot be deleted. It is used to bring the centrifuge to a specific temperature without any vessels.

"--" means that the values that are currently set are not a stored program.

The programs can be protected against unauthorised use, modification, or deletion with the aid of a code (see chapter 6.3.2.7 - "Parameters menu").

Stored programs are listed in the "Process library" menu .

6.3.3.1 Saving a program

- Enter the parameters that are to be included in the program.
- Select the option "Progr" in the "Standard" menu  and confirm the selection. The program list will be displayed.
- Select a storage location from the program list.
- Save the program under the desired name. The letters and characters can be entered when the cursor flashes in the text field.
 - Turn the function knob in order to select a letter and press it to confirm the selection. Then, the next character can be selected.
 - Pressing the arrow button ← will delete the last character.
- When the program name is complete, select "OK" and confirm it.

The program will be saved and the "Standard" menu will be displayed.

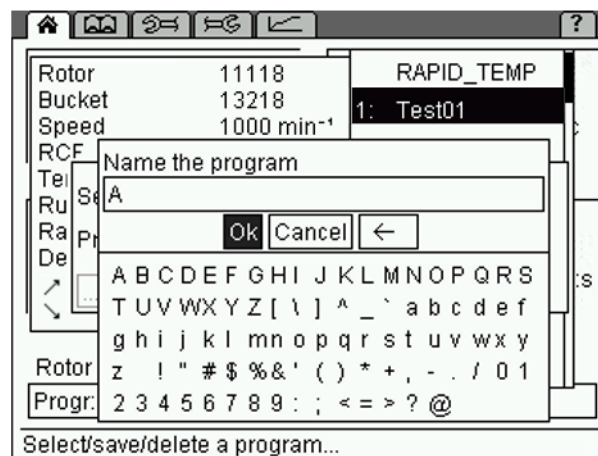



Fig. 35: Assignment of a program name prior to saving the program

6.3.3.2 Loading a program

- Select the option "Progr" from the "Standard" menu  and confirm the selection by pressing the function knob. The program list will be displayed.
- Select the desired program from the list and confirm the selection by pressing the function knob.

Or:

- Open the process library , select the desired program, and confirm the selection by pressing the function knob.

The program will be loaded and the "Standard" menu will be displayed.

6 Using the centrifuge

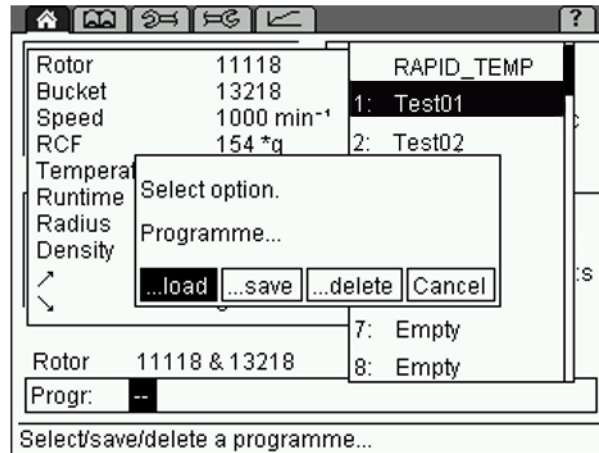



Fig. 36: Loading a program

6.3.3.3 Executing a program

- Select the option "Progr" from the "Standard" menu  and confirm the selection by pressing the function knob. The program list will be displayed.
- Select the desired program from the list and confirm the selection by pressing the function knob.
- Press the start button.

Or:

- Open the process library , select the desired program, and press the start button.

The program will be executed and the "Standard" menu will be displayed.

6.3.3.4 Deleting a program

- Select the option "Progr" in the "Standard" menu  and confirm the selection. The program list will be displayed.
- Select the program that is to be deleted.
- Select the option "Delete" and confirm it.

The program will be deleted and the "Standard" menu will be displayed.

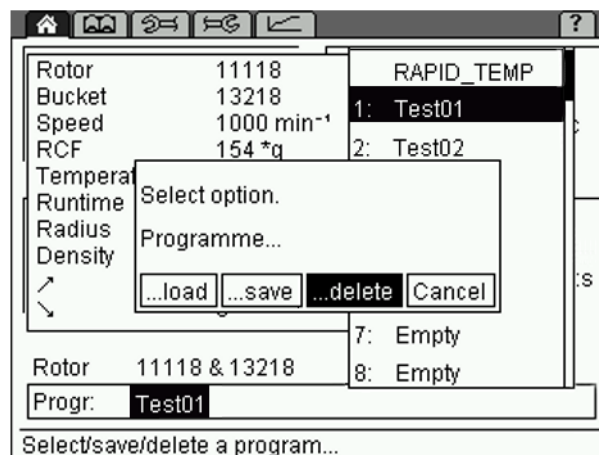



Fig. 37: Deleting a program

6.3.3.5 Automatic program rotation

With the automatic program rotation, several programs can be executed directly one after the other.

- Activate the "Program rotation" function in the "Setup" menu .

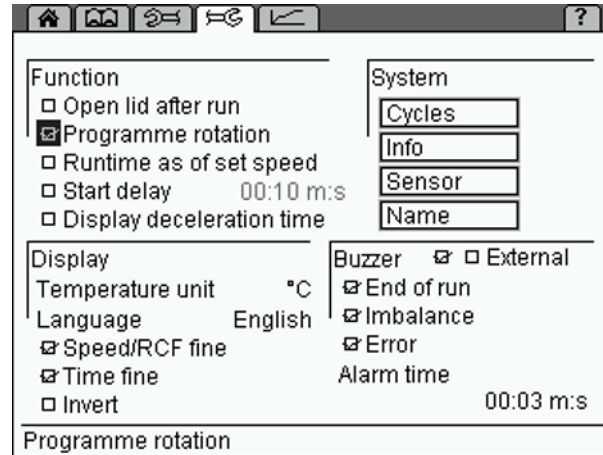

Fig. 38: Program rotation function

When a program is loaded while the program rotation function is active, this program will be used as the start program for the rotation. After the completion of the program, the next program on the program list will be loaded automatically. The rotation continues up to the next empty storage location and then restarts from the beginning (see the following illustration).

Example 1: Loading of Test04

Rotation: Test04, Test05, Test06, Test04,...

Example 2: Loading of Test05

Rotation: Test05, Test06, Test05,...

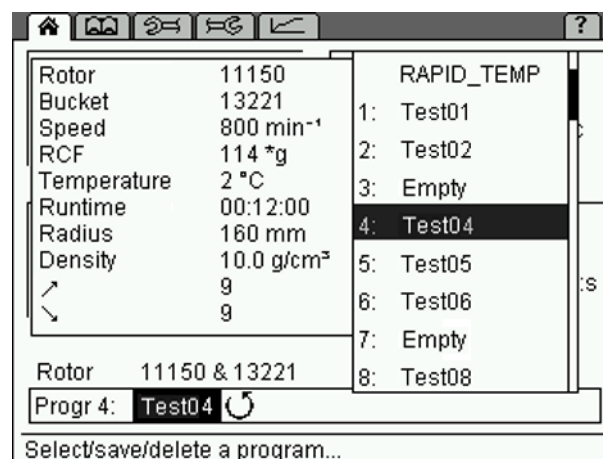

Fig. 39: Automatic program rotation

While the program rotation function is active, the arrow "↻" is displayed in the program line in the "Standard" menu.

6 Using the centrifuge

6.3.4 Options for data input and output

- Serial interface (see chapter 6.3.5 - "Connection of a separate computer")
- External signal active DC 24 V, 0.5 A max. (part no. 17701)
- Floating switch AC 250 V max., 6 A (part no. 17702)
- Connection of a barcode scanner via a barcode extension board (see chapter 6.3.2.10 - "Option: Barcode menu")

6.3.5 Connection of a separate computer

The back of the centrifuge is equipped with a serial interface (see chapter 2.1.1 - "Functional and operating elements") for connecting a computer.

- Plug the connecting cable into the intended port on the back of the centrifuge.

The centrifuge can now be controlled via the computer.



If the centrifuge is controlled via the computer, the display can only be used for display purposes. Only the stop key is active at all times and can be used to switch the centrifuge off in an emergency situation.

6.4 Switching the centrifuge off

- Open the centrifuge when it is not in use so moisture can evaporate.
- Switch the centrifuge off by pressing the mains power switch.

7 Malfunctions and error correction

7.1 General malfunctions

Malfunctions are indicated by a dialog box. If the acoustic signal is activated, it sounds when the error message is displayed.

- Eliminate the source of the problem (see table below).
- Acknowledge the error messages by pressing the lid key.



NOTE

Error messages can be eliminated by pressing the lid key. The error itself will not be eliminated, but the centrifuge can be operated again.

Type of error	Possible reason	Correction
No indication on the display	No power in the mains supply	Check fuse in the mains supply
	Power cord is not plugged in	Plug in power cord correctly
	Fuses have tripped	Have the fuses checked by a qualified electrician
	Mains power switch off	Switch mains power switch on
Centrifuge cannot be started: start key LED is not illuminated	Several possible causes	Power off/on. If the error occurs again, contact service
Centrifuge cannot be started: lid key LED flashes	The lid lock is not closed correctly	Open and close the lid. If the error occurs again, contact service
Centrifuge decelerates during operation	Brief mains power failure	Press start key in order to restart the centrifuge
	System error	Power off/on. If the error occurs again, contact service
Centrifuge decelerates during operation, imbalance dialog box is displayed	<ul style="list-style-type: none"> – Improper loading – Centrifuge is inclined – Drive problem – Centrifuge was moved during run 	Balance load and restart the centrifuge. If the error occurs again, contact service (see chapter 7.1.1 - "Emergency lid release")
	– Ungreased load-bearing bolts	Clean and grease load-bearing bolts
Lid cannot be opened	Lid lock has not released	Unlock the lid manually and contact service
	Lid seal sticks	Clean the lid seal and apply talcum powder
Temperature value cannot be reached (only for refrigerated centrifuges)	Condenser dirty (only air-cooled units)	Clean the condenser. If the error occurs again, contact service

7 Malfunctions and error correction

7.1.1 Emergency lid release

In the event of a power failure, it is possible to manually open the centrifuge lid.

- Switch off the mains power switch and disconnect the power cord from the socket.
- Remove the plugs (see figure, item 1) at the right side panel, e.g. with a screw driver.



Fig. 40: Position of the openings for the emergency lid release

- Insert the supplied tube wrench (part no. 930 110) horizontally into the hole. The key will be guided through a funnel-shaped tube to the shaft of the lid lock motor.



Fig. 41: The emergency lid release key must be inserted horizontally.

- Unlock the motorised lid locks as follows:
 - Turn the left lid lock anti-clockwise.
 - Turn the right lid lock clockwise.
- Then, reinsert the plugs.



WARNING

The lid may only be unlocked and opened when the rotor is at a standstill.

If the lid is opened via the emergency lid release system during a centrifuge run, the centrifuge will be switched off immediately and decelerate in an unbraked manner.

7 Malfunctions and error correction

7.2 Table of error codes

Error no.	Kind of error	Measures	Note
1-9	System error	<ul style="list-style-type: none"> Allow to slow down Power off/on 	All these errors stop the centrifuge or cause it to decelerate brakeless
10-19	Speedometer error	<ul style="list-style-type: none"> Allow to slow down Power off/on 	
20-29	Motor error	<ul style="list-style-type: none"> Power off Ensure ventilation 	
30-39	EEPROM error	<ul style="list-style-type: none"> Allow to slow down Power off/on 	With error 34, 35, and 36, the centrifuge will stop; with error 37 and 38 only an error message will be given
40-45	Temperature error (only for refrigerated centrifuges)	<ul style="list-style-type: none"> Allow to slow down Power off Allow to cool down Provide better ventilation (only air-cooled centrifuges) Provide sufficient water throughput (only water-cooled centrifuges) 	
46-49	Imbalance error (only for centrifuges with imbalance monitoring system)	<ul style="list-style-type: none"> Allow to slow down Power off Eliminate the imbalance 	
50-59	Lid error	<ul style="list-style-type: none"> Press lid key Close lid Remove foreign matter from the opening of the lid lock device 	With error 50 and 51, the centrifuge will stop
60-69	Process error	<ul style="list-style-type: none"> Allow to slow down Power off/on 	With error 60, the message "power failure during run" will be displayed, with error 61, the message "stop after power on" will be displayed
70-79	Communication error	<ul style="list-style-type: none"> Allow to slow down Power off/on 	
80-89	Parameter error	<ul style="list-style-type: none"> Power off Allow to cool down Provide for better ventilation 	With error 83, error message only
90-99	Other errors	<ul style="list-style-type: none"> Check connections Provide sufficient water throughput (only water-cooled centrifuges) 	



If it is impossible to eliminate the errors, contact the service!

7 Malfunctions and error correction

7.3 Service contact

In the event of queries, malfunctions, or spare part enquiries:

From Germany:

Contact

Sigma Laborzentrifugen GmbH
An der Unteren Söse 50
37520 Osterode (Germany)
Tel. +49 (0) 55 22 / 50 07-44 44
E-mail: support.lab@sigma-zentrifugen.de

Outside Germany:

Contact our agency in your country. All agencies are listed at
www.sigma-zentrifugen.de → [Sales Partners]



NOTE

- If you would like to utilise our service, please state the type of your centrifuge and its serial number.

8 Maintenance and service

The centrifuge, rotor, and accessories are subject to high mechanical stress. Thorough maintenance performed by the user extends the service life and prevents premature failure.



CAUTION

If corrosion or other damage occurs due to improper care, the manufacturer cannot be held liable or subject to any warranty claims.

- Use soap water or other water-soluble, mild cleaning agents with a pH value between 6 and 8 for cleaning the centrifuge and accessories (see also chapter 8.2 - "Sterilisation and disinfection of the rotor chamber and accessories").
- Avoid corrosive and aggressive substances.
- Do not use solvents.
- Do not use agents with abrasive particles.
- Do not expose the centrifuge and rotors to intensive UV radiation or thermal stress (e.g. by heat generators).

8.1 Maintenance

8.1.1 Centrifuge

- Unplug the mains power plug before cleaning.
- Carefully remove all liquids, including water and particularly all the solvents, acids, and alkaline solutions from the rotor chamber using a cloth in order to avoid damage to the motor bearings.
- If the centrifuge has been contaminated with toxic, radioactive, or pathogenic substances, clean the rotor chamber immediately with a suitable decontamination agent (depending on the type of contamination).



WARNING

Take suitable precautions for your own safety if there is a risk of toxic, radioactive, or pathogenic contamination.

- After every cleaning process, grease the motor shaft slightly with a small amount of heavy-duty grease for load-bearing bolts (part no. 71401) and distribute the grease with a cloth so that it forms a thin layer.

8 Maintenance and service

8.1.1.1 Condenser (only refrigerated centrifuges with an air-cooled refrigeration system)

In order to cool the refrigerant that is compressed by the refrigeration unit, centrifuges with an air-cooled refrigeration system use a lamellar condenser. It is cooled by air.

Dust and dirt obstruct the cooling flow of air. The dust on condenser pipes and lamellas reduces the heat exchange and thus the performance of the refrigeration unit.

This is why the installation site should be as clean as possible.

- Check the condenser at least once a month for dirt and clean it if necessary.
- If you have any queries, please contact service (see chapter 7.3 - "Service contact").

8.1.2 Accessories



CAUTION

For the care of the accessories, special safety measures must be considered as these are measures that will ensure operational safety at the same time!



WARNING

All swing-out rotors applicable for this centrifuge and the angle rotor 12510 weigh more than 18 kg.

- Always lift the rotors with a lifting device or with a sufficient number of people helping you.

- Immediately rinse off the rotor, buckets, or accessories under running water if they have come into contact with any liquids that may cause corrosion. Use a brush for test tubes to clean the bores of angle rotors. Turn the rotor upside down and allow it to dry completely.
- Clean the accessories outside the centrifuge once a week or preferably after each use. Adapters should be removed, cleaned and dried.



CAUTION

Do not clean the accessories in a dishwasher!

Cleaning in a dishwasher removes the anodised coating; the result is cracking in areas that are subject to stress.

- If the rotors or accessories have been contaminated with toxic, radioactive, or pathogenic substances, clean them immediately with a suitable decontamination agent (depending on the type of contamination). Take suitable precautions for your own safety if there is a risk of toxic, radioactive, or pathogenic contamination.
- Dry the accessories with a soft cloth or in a drying chamber at approx. 50°C.

8.1.2.1 Plastic accessories

The chemical resistance of plastic decreases with rising temperatures (see chapter 11.5 - "Resistance data").

- If solvents, acids, or alkaline solutions have been used, clean the plastic accessories thoroughly.

**WARNING**

Plastic accessories must not be greased!

8.1.3 Rotors, buckets and carriers

Rotors, buckets and carriers are produced with the highest precision, in order to withstand the permanent high stress from high gravitational fields. Chemical reactions as well as stress-corrosion (combination of oscillating pressure and chemical reaction) can affect or destroy the metals. Barely detectable cracks on the surface can expand and weaken the material without any visible signs.

- Check the material regularly (at least once a month) for
 - cracks
 - visible damage of the surface
 - pressure marks
 - signs of corrosion
 - other changes.
- Check the bores of the rotors and multiple carriers.
- Replace any damaged components immediately for your own safety.
- After every cleaning process, grease the rotor tie-down screw slightly with a small amount of heavy-duty grease for load-bearing bolts (part no. 71401) and distribute the grease with a cloth so that it forms a thin layer.

8 Maintenance and service

8.1.4 Load bearing bolts

Only greased load-bearing bolts ensure a uniform swing-out of the buckets and, therefore, the smooth operation of the centrifuge. Load-bearing bolts that are insufficiently greased may cause the centrifuge to stop due to an imbalance.

- Clean the load-bearing bolts and bucket groove in order to remove the old grease.
- Apply a small amount of heavy-duty grease for load-bearing bolts (ref. no. 71401, see the following picture) to both load-bearing bolts of a bucket.



Fig. 42: Sufficient quantity of grease for one bolt

- Install the bucket and swing it manually back and forth once in order to distribute the grease.
- Repeat this process with all the other buckets.

8.1.5 Glass breakage

**CAUTION**

In the case of glass breakage, immediately remove all glass particles (e.g. with a vacuum cleaner). Replace the rubber cushions since even thorough cleaning will not remove all glass particles.

Glass particles will damage the surface coating (e.g. anodising) of the buckets, which will then lead to corrosion.

Glass particles in the rubber cushions of the buckets will cause glass breakage again.

Glass particles on the pivot bearing of the load-bearing bolts prevent the buckets and carriers from swinging evenly, which will cause an imbalance.

Glass particles in the rotor chamber will cause metal abrasion due to the strong air circulation. This metal dust will not only pollute the rotor chamber, rotor, and materials to be centrifuged but also damage the surfaces of the accessories, rotors, and rotor chamber.

In order to completely remove the glass particles and metal dust from the rotor chamber:

- Grease the upper third of the rotor chamber with e.g. Vaseline.
- Then, let the rotor rotate for a few minutes at a moderate speed (approx. 2000 rpm). The glass and metal particles will now collect at the greased part.
- Remove the grease with the glass and metal particles with a cloth.
- If necessary, repeat this procedure.

8.2 Sterilisation and disinfection of the rotor chamber and accessories

- Use commercially-available disinfectants such as, for example, Sagrotan[®], Buraton[®], or Terralin[®] (available at chemist's shops or drugstores).
- The centrifuge and the accessories consist of various materials. A possible incompatibility must be considered.
- Before using cleaning or decontamination agents that were not recommended by us, contact the manufacturer to ensure that such a procedure will not damage the centrifuge.
- For autoclaving, consider the continuous heat resistance of the individual materials (see chapter 8.2.1 - "Autoclaving").

Please contact us if you have any queries (see chapter 7.3 - "Service contact").

**DANGER**

If dangerous materials (e.g. infectious and pathogenic substances) are used, the centrifuge and accessories must be disinfected.

8 Maintenance and service

8.2.1 Autoclaving

The service life of the accessories essentially depends on the frequency of autoclaving and use.

- Replace the accessories immediately when the parts show changes in colour or structure or in the occurrence of leaks etc.
- During autoclaving, the caps of the tubes must not be screwed on in order to avoid the deformation of the tubes.



NOTE

It cannot be excluded that plastic parts, e.g. lids or carriers, may deform during autoclaving.

Category	Type of accessory	Material abbreviation	121 °C 20 min	134 °C 20 min	Remarks
Rotors and lids	Aluminium rotors	AL	yes	yes	
	Polypropylen rotors	PP	no	no	
	Polycarbonate lids for angle rotors	PC	no	no	
	Polyallomer lids for angle rotors	PA	no	no	
	Polysulfone lids for angle rotors	PSU	yes	yes	100 cycles max.
Buckets and caps	Aluminium buckets	AL	yes	yes	
	Polyamide buckets	PA	no	no	13035, 13296, 13299
	Polyphenylsulfone caps	PPSU	yes	yes	100 cycles max.
	Polysulfone caps	PSU	yes	yes	100 cycles max.
Adapters	Polyallomer carriers	PA	no	no	
	Polycarbonate carriers	PC	no	no	
	Polypropylene carriers	PP	no	no	
Tubes	Stainless steel tubes and bottles	--	yes	no	
	Glass tubes	--	yes	yes	
	Polyethylene tubes	PE	no	no	
	Polyflor tubes	PF	yes	yes	100 cycles max.
	Polycarbonate tubes	PC	no	no	
	Polypropylene copolymer tubes	PPCO	yes	no	20 cycles max.
	Polystyrene tubes	PS	no	no	
Additional equipment	Stainless-steel balance weight for blood-bag systems	--	yes	no	

8.3 Service



DANGER

In the event of service work that requires the removal of the panels, there is a risk of electric shock or mechanical injury.

- Only qualified specialist personnel is authorised to perform this service work.
- Following the completion of any type of service, the qualified and specialised personnel must perform final inspection and testing in compliance with the relevant standards.

The centrifuge is subject to high mechanical stress. In order to be able to withstand this high level of stress, high-quality components were used during the production of the centrifuge. Nevertheless, wear cannot be excluded and it may not be visible from the outside. Especially the rubber parts that are – among other things – part of the motor suspension, are subject to ageing.

This is why we recommend having the centrifuge checked by the manufacturer during an inspection once per year in the operating state and once every three years in the dismantled state. Motor damping elements must be replaced after three years.

Information and appointments:

In Germany:

Contact

Sigma Laborzentrifugen GmbH

An der Unteren Söse 50

37520 Osterode (Germany)

Tel. +49 (0) 55 22 / 50 07-44 44

E-mail: support.lab@sigma-zentrifugen.de

Outside Germany:

Contact our agency in your country. All agencies are listed at www.sigma-zentrifugen.de → [Sales Partners]



- If you would like to utilise our service, please state the type of your centrifuge and its serial number.

8 Maintenance and service

8.4 Return of defective centrifuges or parts

Although we exercise great care during the production of our products, it may be necessary to return a unit or accessory to the manufacturer.

In order to ensure the quick and economical processing of returns of centrifuges, spare parts, or accessories, we require complete and extensive information concerning the process. Please fill in the following forms completely, sign them, enclose them with the return package, and send them together with the product to:

Sigma Laborzentrifugen GmbH
An der Unteren Söse 50
37520 Osterode (Germany)

1. Declaration of decontamination

As a certified company and due to the legal regulations for the protection of our employees and of the environment, we are obliged to certify the harmlessness of all incoming goods. For this purpose, we require a declaration of decontamination.

- The form must be filled in completely and signed by authorised and specialised personnel only.
- Affix the original form in a clearly visible manner to the outside of the packaging.



We will return the part/unit if no declaration of decontamination is provided!

2. Form for the return of defective parts

This form is for the product-related data. They facilitate the assignment, and they enable the quick processing of the return. If several parts are returned together in one packaging, please enclose a separate problem description for every defective part.

- A detailed problem description is necessary in order to perform the repair quickly and economically.



If the form does not include a description of the malfunction, neither a refund nor a credit note can be issued. In this case, we reserve the right to return the part/unit to you at your expense.

- Upon request, we will prepare and submit to you a cost estimate prior to performing the repair. Please confirm such cost estimate within 14 days. If the cost estimate has still not been confirmed after 4 weeks, we will return the defective part/unit. Please note that you must bear the incurred costs.



The defective part/unit must be packaged in a transport-safe manner. Please use the original packaging for the unit, if at all possible. If the product is dispatched to us in unsuitable packaging, you will be charged the cost for returning it to you in new packaging.

The forms can be downloaded online from
www.sigma-zentrifugen.de → [Service] → [Overhaul and repair].

9 Disposal

9 Disposal

9.1 Disposal of the centrifuge



In accordance with the directive 2012/19/EU, SIGMA centrifuges are marked with the symbol shown to the left. This symbol means that it is not permissible to dispose of the unit among household waste.

- You can return these centrifuges free of cost to Sigma Laborzentrifugen GmbH.
- Ensure that the unit is decontaminated. Fill in a declaration of decontamination (see chapter 8.4 - "Return of defective centrifuges or parts").
- Comply with any other applicable local rules and regulations.

9.2 Disposal of the packaging

- Use the packaging to return the centrifuge for disposal or
- dispose of the packaging, after having separated the individual materials.
- Comply with all local rules and regulations.

10 Technical data

Manufacturer	Sigma Laborzentrifugen GmbH An der Unteren Söse 50 37520 Osterode (Germany)	
Type:	Sigma 8KS	Sigma 8KS, Clinic
Order number:	10630, 10631, 10632, 10633, 91300, 91301, 91367, 91583, 190010	91594
<u>Performance data</u>		
Max. speed (rpm):	10,500	4,100
Max. capacity (ml):	12,000	9,000
Max. gravitational field (x g):	20,954	5,544
Max. kinetic energy (Nm):	280,080	280,080
<u>Connection requirements</u>		
Electr. connection:	see name plate	
Protection class:	I	
IP code:	20	
Power consumption (kW):	6.5 (at 3 x 400 V, 50 Hz) 6.5 (at 3 x 220 V, 60 Hz) 6.5 (at 3 x 400 V, 60 Hz) 6.5 (at 3 x 480 V, 60 Hz)	
Input fuse (AT):	16.0 (at 3 x 400 V, 50 Hz) 35.0 (at 3 x 220 V, 60 Hz) 16.0 (at 3 x 400 V, 60 Hz) 16.0 (at 3 x 480 V, 60 Hz)	
<u>Other parameters</u>		
Time range:	10 sec to 99 h 59 min, short run, continuous run	
Temperature range:	-20 to +40°C	
Storage locations:	60	
<u>Physical data</u>		
Height (mm):	990	
Height with open lid (mm):	1,679	
Width (mm):	810	
Depth (mm):	949	
Weight (kg):	450	
Noise level (dB(A)):	< 73 (at maximum speed)	
<u>Refrigerant data</u> (see name plate)		
Refrigerant:	R452A	
Global warming potential (GWP):	2,140	
Filling quantity (kg):	2.280	
Max. permissible pressure (bar):	28	
CO ₂ equivalent (t):	4.879	
<u>Special equipment: Water cooling system</u>		
Tap connections (inch):	2 x ¾	
Inlet pressure (bar):	1.5 to 5.0	
Min. flow rate (l/min):	5 (at maximum power)	
Max. temperature at water inlet (°C):	20	

10 Technical data

10.1 Ambient conditions

- The figures are valid for an ambient temperature of +23°C and a nominal voltage $\pm 10\%$. The minimum temperature is $\leq +4^\circ\text{C}$ and depends on the rotor type, speed, and ambient temperature.
- For indoor use only.
- Allowable ambient temperature +5°C to +35°C.
- Max. allowable relative humidity of air 80% from 5°C up to 31°C with a linear decrease to 67% relative humidity of air at 35°C.
- Maximum altitude 2,000 m above sea level.

10.2 Technical documentation

For environmental reasons, the comprehensive technical documentation of the centrifuge (e.g. circuit diagrams) and the safety data sheets of the manufacturers of refrigerants and lubricants are not attached to this documentation.

You can order these documents from our service department.

11 Appendix

11.1 Range of accessories

The complete list of accessories can be downloaded from www.sigma-zentrifugen.de.

11.1.1 Rotor radii

The information in the accessories table concerning the radius refers to the values of the respective rotor as shown below. The radius calculation is described in chapter 2.2.2.1 - "Speed, radius, and relative centrifugal force".

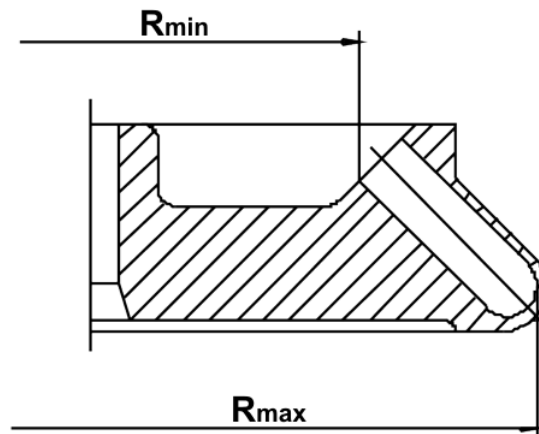

Fig. 43: Minimum and maximum radius of an angle rotor

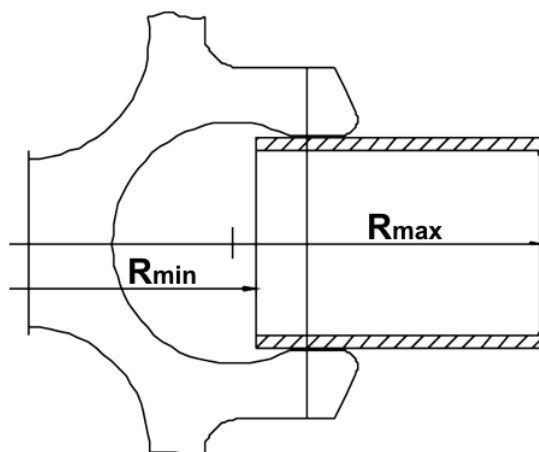

Fig. 44: Minimum and maximum radius of a swing-out rotor

11 Appendix

11.2 Speed-gravitational-field-diagram

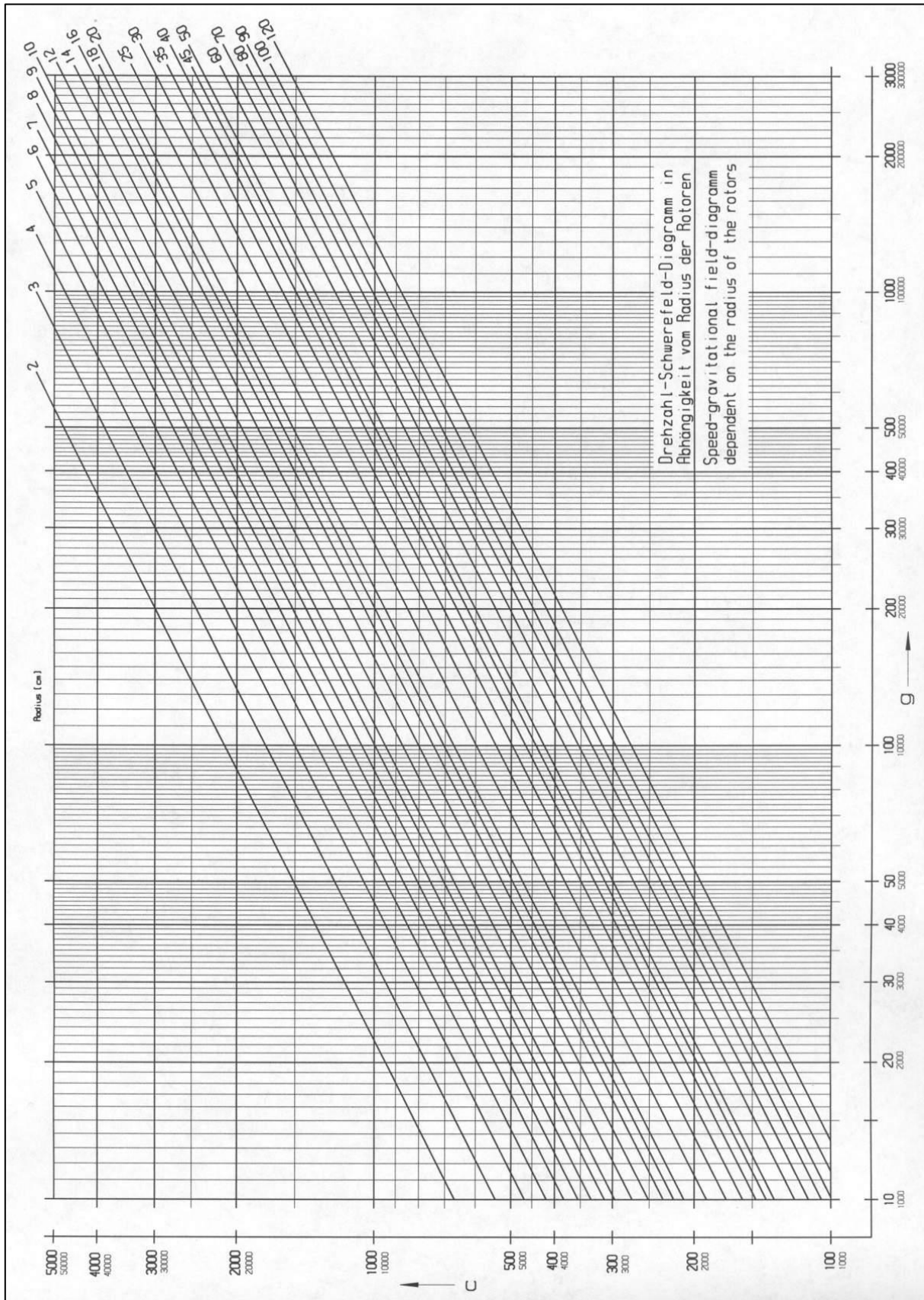

Fig. 45: Speed-gravitational-field-diagram

11.3 Acceleration and deceleration curves

Linear as well as quadratic curves are numbered in the direction of increasing acceleration (from right to left).

The deceleration curves are inverted images of the acceleration curves and are assigned the same numbers. An exception is curve 0. It decelerates brakeless (spin-out).

In general, the runtime, until the set speed is reached, depends on the moment of inertia of the rotor.

Linear curves

The slope of the fixed acceleration curves defines the time that is required to accelerate the rotor by 1,000 rpm.

Curve 9 is a special case compared to the other curves. The centrifuge accelerates with maximum power. The runtime, until the set speed is reached, depends solely on the moment of inertia of the rotor.

Linear curve no.	Slope
0	4 [rpm/sec]
1	6 [rpm/sec]
2	8 [rpm/sec]
3	17 [rpm/sec]
4	25 [rpm/sec]
5	33 [rpm/sec]
6	50 [rpm/sec]
7	100 [rpm/sec]
8	200 [rpm/sec]
9	1.000 [rpm/sec]

Fig. 46: Slope of linear curves

Quadratic curves

Curve 19 is a special case compared to the other curves. The centrifuge accelerates with maximum power. The runtime depends solely on the moment of inertia of the rotor.

Quadratic curve no.	Time until 1,000 rpm	Slope as of 1,000 rpm
10	500 sec	4 [rpm/sec]
11	333 sec	6 [rpm/sec]
12	250 sec	8 [rpm/sec]
13	118 sec	17 [rpm/sec]
14	80 sec	25 [rpm/sec]
15	60 sec	33 [rpm/sec]
16	40 sec	50 [rpm/sec]
17	20 sec	100 [rpm/sec]
18	10 sec	200 [rpm/sec]
19	2 sec	1.000 [rpm/sec]

Fig. 47: Slope of quadratic curves

11 Appendix

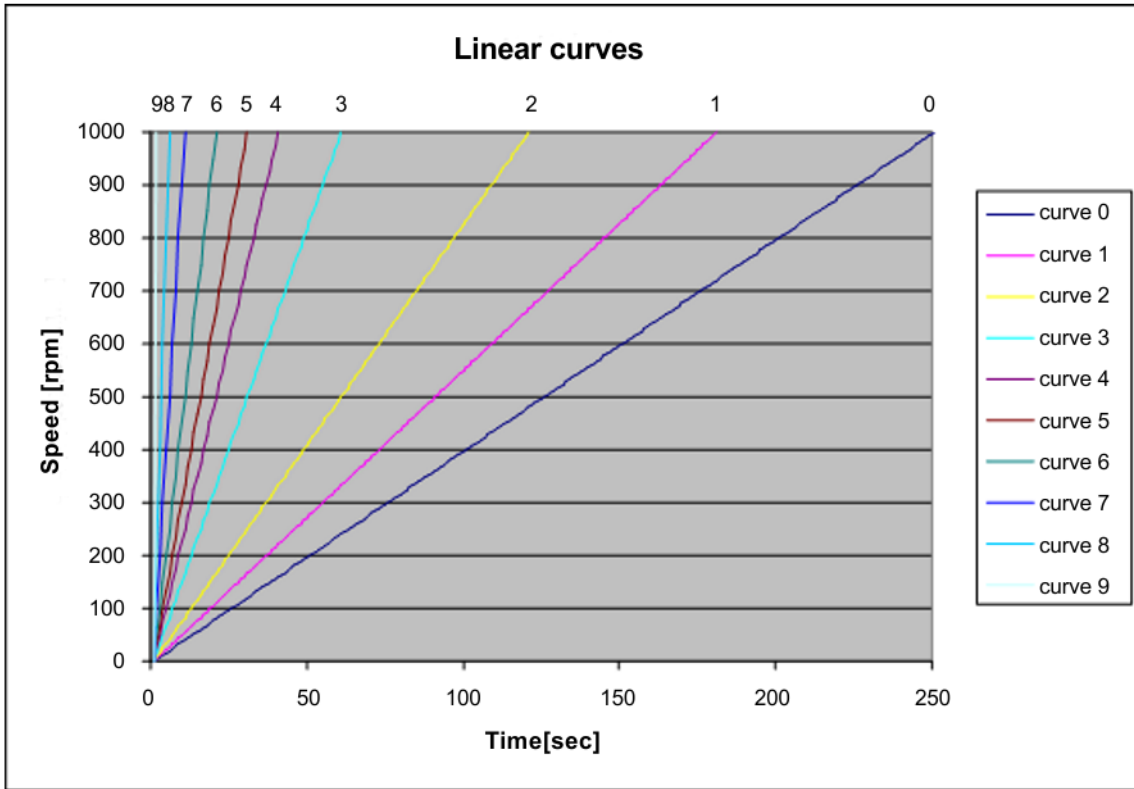

Fig. 48: Diagram of linear curves

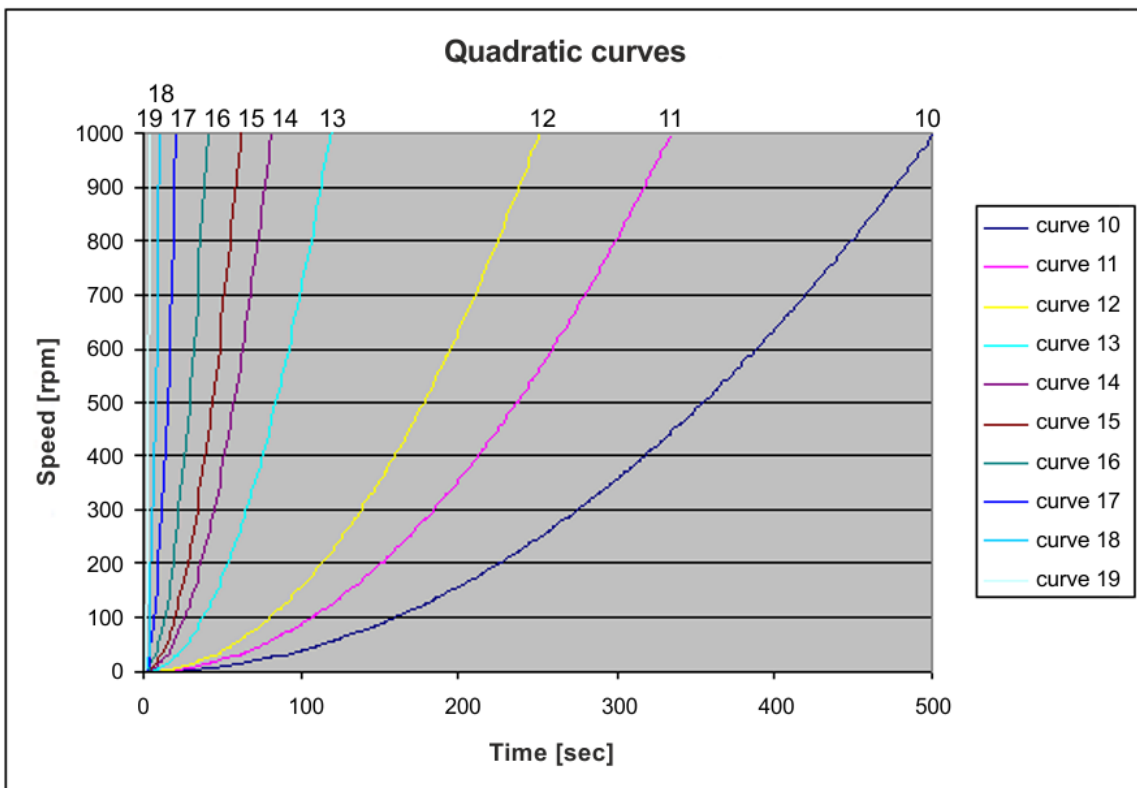

Fig. 49: Diagram of quadratic curves

11.4 Table of the service life of rotors and accessories

- If no other data concerning the service life are engraved on the rotor or accessory, rotors and buckets must be checked by the manufacturer after 10 years.
- If a specification concerning the maximum number of cycles **and** a specification concerning the service life (i.e. a date) are provided, the specification that occurs first shall apply.
- After 50,000 cycles, rotors must be scrapped for safety reasons.

Rotor / bucket	Cycles	Service life ("Exp.Date")	Suitable for centrifuge	Remarks
9100	35,000		4-16S, 4-16KS, 4-16KHS, 6-16S, 6-16HS, 6-16KS, 6-16KHS	
9366	15,000		4-5KL, 4-16S, 4-16KS, 4-16KHS, 6-16S, 6-16HS, 6-16KS, 6-16KHS	
11805		10 years	8KS, 8KBS	
11806		10 years	8KS, 8KBS	
12082		7 years	1-14, 1-14K	
12083		7 years	1-14, 1-14K	
12084		7 years	1-14, 1-14K	
12085		7 years	1-14, 1-14K	
12092		5 years	1-14, 1-14K	
12093		5 years	1-14, 1-14K	
12094		5 years	1-14, 1-14K	
12096		5 years	1-14, 1-14K	
12097		5 years	1-14, 1-14K	
12134		5 years	1-16, 1-16K	
12135		5 years	1-16, 1-16K	
12137		5 years	1-16, 1-16K	
12500		7 years	6-16S, 6-16HS, 6-16KS, 6-16KHS	
12600		7 years	6-16S, 6-16HS, 6-16KS, 6-16KHS	
13035			2-7	Do not grease the load-bearing bolts of the rotor
13218	20,000		4-16S, 4-16KS, 4-16KHS, 6-16S, 6-16HS, 6-16KS, 6-16KHS	
13221	10,000		4-16S, 4-16KS, 4-16KHS, 6-16S, 6-16HS, 6-16KS, 6-16KHS	
13296	35,000	5 years	2-7, 2-16P, 2-16KL, 2-16KHL	Do not grease the load-bearing bolts of the rotor
13299		5 years	2-7, 2-16P, 2-16KL, 2-16KHL, 3-30KS, 3-30KHS	Do not grease the load-bearing bolts of the rotor
13635	25,000		6-16S, 6-16HS, 6-16KS, 6-16KHS	
13650	20,000		6-16S, 6-16HS, 6-16KS, 6-16KHS	
13845	20,000		8KS	
13850	10,000	10 years	8KS	
13860	15,000	10 years	8KBS	
91060	10,000		6-16S, 6-16HS	Special software required

11 Appendix

11.5 Resistance data



The data refer to resistance at 20°C.

- no data 1 resistant 2 practically resistant 3 partially resistant 4 not resistant	Medium	Formula	Concentration [%]	High Density Polyethylene	Polyamide	Polycarbonate	Polyoxymethylene	Polypropylene	Polysulfone	Polyvinyl chloride, hard	Polyvinyl chloride, soft	Polytetrafluorethylene	Acrylonitrile-butadiene- caoutchouc	Aluminium
				HDPE	PA	PC	POM	PP	PSU	PVC	PVC	PTFE	NBR	AL
	Acetaldehyde	C ₂ H ₄ O	40	3	2	4	2	3	4	4	-	1	4	1
	Acetamide	C ₂ H ₅ NO	saturated	1	1	4	1	1	4	4	-	1	-	1
	Acetone	C ₃ H ₆ O	100	1	1	4	1	1	4	4	-	1	4	1
	Acrylonitrile	C ₃ H ₃ N	100	1	1	4	3	3	4	4	4	1	4	1
	Allyl alcohol	C ₃ H ₆ O	96	1	3	3	2	2	2	2	4	1	1	1
	Aluminium chloride	AlCl ₃	saturated	1	3	2	4	1	-	1	-	1	1	4
	Aluminium sulfate	Al ₂ (SO ₄) ₃	10	1	1	1	3	1	1	1	1	1	1	1
	Ammonium chloride	(NH ₄)Cl	aqueous	1	1	1	2	1	1	1	1	1	1	3
	Ammonium hydroxide	NH ₃ + H ₂ O	30	1	3	4	1	1	2	1	-	1	-	1
	Aniline	C ₆ H ₇ N	100	1	3	4	1	2	4	4	4	1	4	1
	Anisole	C ₇ H ₈ O	100	3	4	4	1	4	4	2	-	1	4	1
	Antimony trichloride	SbCl ₃	90	1	4	1	4	1	-	1	-	1	-	4
	Benzaldehyde	C ₇ H ₆ O	100	1	3	4	1	1	3	4	4	1	4	1
	Benzene	C ₆ H ₆	100	3	2	4	1	3	4	4	-	1	4	1
	Boric acid	H ₃ BO ₃	aqueous	1	3	1	2	1	-	-	-	1	1	1
	Butyl acrylate	C ₇ H ₁₂ O ₂	100	1	2	4	2	3	4	4	4	1	-	1
	Butyl alcohol, normal	C ₄ H ₁₀ O	100	1	1	2	1	1	2	2	4	1	1	1
	Calcium chloride	CaCl ₂	alcoholic	1	4	2	3	1	-	-	4	1	1	3
	Carbon disulfide	CS ₂	100	4	3	4	2	4	4	4	4	1	3	1
	Carbon tetrachloride (TETRA)	CCl ₄	100	4	4	4	2	4	4	4	4	1	3	1
	Chlorine	Cl ₂	100	4	4	4	4	4	4	4	4	1	-	3
	Chlorine water	Cl ₂ x H ₂ O		3	4	4	4	3	-	3	3	1	-	4
	Chlorobenzene	C ₆ H ₅ Cl	100	3	4	4	1	3	4	4	4	1	4	1
	Chloroform	CHCl ₃	100	3	3	4	4	3	4	4	4	1	4	3

11 Appendix

- no data 1 resistant 2 practically resistant 3 partially resistant 4 not resistant	Medium	Formula	Concentration [%]	High Density Polyethylene	Polyamide	Polycarbonate	Polyoxymethylene	Polypropylene	Polysulfone	Polyvinyl chloride, hard	Polyvinyl chloride, soft	Polytetrafluorethylene	Acrylonitrile-butadiene- caoutchouc	Aluminium
				HDPE	PA	PC	POM	PP	PSU	PVC	PVC	PTFE	NBR	AL
	Chromic acid	CrO ₃	10	1	4	2	4	1	4	1	-	1	4	1
	Chromic potassium sulphate	KCr(SO ₄) ₂ x 12H ₂ O	saturated	1	2	1	3	1	-	1	-	1	-	3
	Citric acid	C ₆ H ₈ O ₇	10	1	1	1	2	1	1	1	1	1	1	1
	Citric acid	C ₆ H ₈ O ₇	50	1	3	1	2	1	-	-	-	1	1	1
	Copper sulphate	CuSO ₄ x 5H ₂ O	10	1	1	1	1	1	1	1	1	1	1	4
	Cyclohexanol	C ₆ H ₁₂ O	100	1	1	3	1	1	1	1	4	1	2	1
	Decane	C ₁₀ H ₂₂	100	-	1	2	1	3	-	-	-	1	2	1
	Diaminoethane	C ₂ H ₈ N ₂	100	1	1	3	1	1	-	3	4	1	1	1
	Diesel fuel	—	100	1	1	3	1	1	-	1	3	1	1	1
	Dimethyl formamide (DMF)	C ₃ D ₇ NO	100	1	1	4	1	1	4	3	-	1	3	1
	Dimethyl sulfoxide (DMSO)	C ₂ H ₆ SO	100	1	2	4	1	1	4	4	-	1	-	1
	Dimethylaniline	C ₈ H ₁₁ N	100	-	3	4	2	4	-	-	-	1	-	1
	Dioxane	C ₄ H ₈ O ₂	100	2	1	4	1	3	2	3	4	1	3	1
	Dipropylene glycol (mono)methyl ether	C ₄ H ₁₀ O	100	3	1	4	1	4	4	4	4	1	-	1
	Ethyl acetate	C ₄ H ₈ O ₂	100	1	1	4	1	1	4	4	4	1	4	1
	Ethylene chloride	C ₂ H ₄ Cl ₂	100	3	3	4	1	3	4	4	4	1	-	1
	Ferrous chloride	FeCl ₂	saturated	1	3	1	3	1	1	1	1	1	-	4
	Formaldehyde solution	CH ₂ O	30	1	3	1	1	1	-	-	-	1	2	1
	Formic acid	CH ₂ O ₂	100	1	4	3	4	1	3	3	1	1	2	1
	Furfural	C ₅ H ₄ O ₂	100	1	3	3	2	4	-	-	-	1	4	1
	Gasoline	C ₅ H ₁₂ - C ₁₂ H ₂₆	100	2	1	3	1	3	3	2	-	1	1	1
	Glycerol	C ₃ H ₈ O ₃	100	1	1	3	1	1	1	1	2	1	1	1
	Heptane, normal	C ₇ H ₁₆	100	2	1	1	1	2	1	2	4	1	1	1
	Hexane, n-	C ₆ H ₁₄	100	2	1	2	1	2	1	2	4	1	1	1
	Hydrogen chloride	HCl	5	1	4	1	4	1	1	1	-	1	2	4
	Hydrogen chloride	HCl	concentrated	1	4	4	4	1	1	2	3	1	4	4
	Hydrogen peroxide	H ₂ O ₂	3	1	3	1	1	1	1	1	-	1	3	3
	Hydrogen peroxide	H ₂ O ₂	30	1	4	1	4	1	1	1	-	1	3	3
	Hydrogen sulphide	H ₂ S	10	1	1	1	1	1	1	1	3	1	3	1
	Iodine, tincture of	I ₂		1	4	3	1	1	-	4	4	1	1	1

11 Appendix

- no data 1 resistant 2 practically resistant 3 partially resistant 4 not resistant	Medium	Formula	Concentration [%]	High Density Polyethylene	Polyamide	Polycarbonate	Polyoxymethylene	Polypropylene	Polysulfone	Polyvinyl chloride, hard	Polyvinyl chloride, soft	Polytetrafluorethylene	Acrylonitrile-butadiene- caoutchouc	Aluminium
				HDPE	PA	PC	POM	PP	PSU	PVC	PVC	PTFE	NBR	AL
	Isopropyl alcohol	C ₃ H ₈ O	100	1	1	1	1	1	1	1	4	1	-	2
	Lactic acid	C ₃ H ₆ O ₃	3	1	3	1	2	1	1	2	-	1	1	1
	Magnesium chloride	MgCl ₂	10	1	1	1	1	1	1	1	1	1	1	1
	Mercuric chloride	HgCl ₂	10	1	4	1	3	1	1	1	1	1	1	4
	Mercury	Hg	100	1	1	1	1	1	1	1	3	1	1	3
	Methyl acetate	C ₃ H ₆ O ₂	100	1	1	4	2	1	-	4	4	1	-	1
	Methyl alcohol	CH ₄ O	100	1	2	4	1	1	3	1	3	1	2	1
	Methyl benzene	C ₇ H ₈	100	3	1	4	1	3	4	4	4	1	4	1
	Methyl ethyl ketone (MEK)	C ₄ H ₈ O	100	1	1	4	1	1	4	4	4	1	4	1
	Methylene chloride	CH ₂ Cl ₂	100	4	3	4	3	3	4	4	4	1	-	1
	Mineral oil	—	100	1	1	1	1	1	1	1	-	1	1	1
	Nitric acid	HNO ₃	10	1	4	1	4	1	1	1	-	1	4	3
	Nitric acid	HNO ₃	100	4	4	4	4	4	-	4	-	1	4	1
	Nitrobenzene	C ₆ H ₅ NO ₂	100	3	4	4	3	2	4	4	4	1	4	1
	Oleic acid	C ₁₈ H ₃₄ O ₂	100	1	1	1	2	1	-	1	-	1	3	1
	Oxalic acid	C ₂ H ₂ O ₄ x 2H ₂ O	100	1	3	1	4	1	1	1	1	1	2	1
	Ozone	O ₃	100	3	4	1	4	3	1	1	-	1	4	2
	Petroleum	—	100	1	1	3	1	1	1	1	3	1	1	1
	Phenol	C ₆ H ₆ O	10	1	4	4	4	1	4	1	3	1	3	1
	Phenol	C ₆ H ₆ O	100	2	4	4	4	1	3	4	3	1	3	1
	Phosphoric acid	H ₃ PO ₄	20	1	4	2	4	1	-	-	-	1	2	4
	Phosphorus pentachloride	PCl ₅	100	-	4	4	4	1	-	4	4	1	-	1
	Potassium hydrogen carbonate	CHKO ₃	saturated	1	1	2	1	1	-	-	-	1	-	4
	Potassium hydroxide	KOH	30	1	1	4	3	1	1	1	1	1	-	4
	Potassium hydroxide	KOH	50	1	1	4	3	1	1	1	1	1	-	4
	Potassium nitrate	KNO ₃	10	1	1	1	1	1	-	-	-	1	1	1
	Potassium permanganate	KMnO ₄	100	1	4	1	1	1	-	1	-	1	3	1
	Pyridine	C ₅ H ₅ N	100	1	1	4	1	3	4	4	4	1	4	1
	Resorcinol	C ₆ H ₆ O ₂	5	1	4	2	3	1	4	2	-	1	-	2
	Silver nitrate	AgNO ₃	100	1	1	1	1	1	1	1	1	1	2	4

11 Appendix

- no data 1 resistant 2 practically resistant 3 partially resistant 4 not resistant		Concentration	High Density Polyethylene	Polyamide	Polycarbonate	Polyoxymethylene	Polypropylene	Polysulfone	Polyvinyl chloride, hard	Polyvinyl chloride, soft	Polytetrafluorethylene	Acrylonitrile-butadiene-caoutchouc	Aluminium
			Medium	Formula	[%]	HDPE	PA	PC	POM	PP	PSU	PVC	PVC
	Sodium bisulphite	NaHSO ₃	10	1	1	2	4	1	-	-	1	1	1
	Sodium carbonate	Na ₂ CO ₃	10	1	1	1	1	1	-	-	1	-	3
	Sodium chloride	NaCl	30	1	1	1	1	1	1	1	1	1	3
	Sodium hydroxide	NaOH	30	1	1	4	1	1	1	1	1	2	4
	Sodium hydroxide	NaOH	50	1	1	4	1	1	1	1	1	2	4
	Sodium sulfate	Na ₂ SO ₄	10	1	1	1	1	1	1	1	1	1	1
	Spirits	C ₂ H ₆ O	96	1	1	1	1	1	1	3	1	-	1
	Styrene	C ₈ H ₈	100	4	1	4	1	3	-	4	4	4	1
	Sulphuric acid	H ₂ SO ₄	6	1	4	1	4	1	1	1	-	1	2
	Sulphuric acid	H ₂ SO ₄	fuming	4	4	4	4	4	4	4	4	1	4
	Tallow	—	100	1	1	1	1	1	-	1	1	1	1
	Tetrahydrofuran (THF)	C ₄ H ₈ O	100	3	1	4	1	3	4	4	4	1	3
	Tetrahydronaphthalene	C ₁₀ H ₁₂	100	3	1	4	1	4	4	4	4	1	-
	Thionyl chloride	Cl ₂ SO	100	4	4	4	2	4	4	4	4	1	-
	Tin chloride	SnCl ₂	10	1	4	2	2	1	-	-	-	1	1
	Transformer oil	—	100	1	1	3	3	1	1	1	-	1	1
	Trichloroethane	C ₂ H ₃ Cl ₃	100	3	3	4	2	4	4	4	4	1	4
	Urea	CH ₄ N ₂ O	10	1	1	1	1	1	-	-	-	1	1
	Urine	—	100	1	1	1	1	1	-	1	1	1	-
	Vinegar	C ₂ H ₄ O ₂	10	1	4	1	1	1	1	1	1	1	2
	Vinegar	C ₂ H ₄ O ₂	90	1	4	4	4	1	3	1	4	1	-
	Wax	—	100	-	1	1		1	-	-	-	1	-
	Wines	—	100	1	1	1	2	1	1	1	1	1	-
	Xylene	C ₈ H ₁₀	100	3	1	4	1	4	4	4	4	1	4

11 Appendix

11.6 Serial Control Interface Specification

V2.8 SERIAL CONTROL INTERFACE SPECIFICATION 

Serial Control Interface Specification

Spincontrol

Version: V2.8
Date: 23.08.2023
File: rs232_spincontrol.doc

PAGE 1

11 Appendix

V 2. 8

SERIAL CONTROL INTERFACE SPECIFICATION



1 Contents

1	Contents	2
2	Introduction	3
3	General specifications	3
4	Communication protocol	3
4.1	Reset message	4
4.2	General user commands	4
4.2.1	Overview of commands	4
4.2.2	Control commands	4
4.2.3	Commands to change the setpoints	4
4.2.4	Commands to request process values	5
4.2.5	Commands to request setpoints	5
4.2.6	Commands to change parameters	5
4.2.7	Commands to read parameters	5
4.2.8	Commands to request the status	6
4.2.9	Other commands	6
4.3	Additional commands of Spincontrol S and Professional	9
4.3.1	Commands related to curves	9
4.3.2	Data of last run	10
4.3.3	Commands related to programs	15
4.3.4	Other commands	16
4.4	Additional commands of Spincontrol S	16
4.5	Commands of centrifuges for robot placement	18
4.5.1	Commands for control panel	18
4.5.2	Commands for motor driven lid or hatch	18
4.5.3	Commands for rotor positioning	18
4.5.4	Commands for bucket lifter unit	18
4.5.5	Commands for Rotor Cycle Counter	19
4.5.6	Commands for Servo Cycle Counters	19
4.6	Table of user commands	20
5	Examples	23
6	Hardware interface (optional accessory)	24
6.1	Pinning of the connector	24
6.2	Typical connection to a PC	24

2 Introduction

This document describes the hardware specification and software protocol to communicate with a serial RS232 connection to a sigma centrifuge with Spincontrol electronics.

The serial interface offers the possibility of firmware updates (by service technician), control and monitoring of centrifuge parameters and also the readout of service data like error list and cycles.

The communication data is ASCII coded for easy access with standard terminal software, e.g. "zoc" (<http://www.emtec.com/zoc/>) which offers an easy way to monitor and log the centrifuge process parameters.

The Spincontrol serial protocol is syntax compatible to the older Zent2 protocol used in Sigma Robot centrifuges. In contrast to the Zent2 protocol the character echo is not enabled by default. This protocol is also fully compatible to labworldsoft® (<http://www.labworldsoft.com/>), an innovative windows software application for laboratory automation which allows measuring, controlling and regulating of all centrifuge operations.

3 General specifications

Interface standard:	RS232
Baud rate:	9600
Parity:	No
Data bits:	8
Stopbits:	1
Data format:	ASCII

The serial communication works without hardware- or XON/XOFF software handshake.

4 Communication protocol

User commands consist of an ASCII-coded command string and - if needed - a parameter set separated from the command by a space. The parameter set consists of one or more parameters, each separated by a comma. The command parser works non case sensitive.

The character received won't be echoed by the centrifuge processor normally, except if barcode menu is implemented in the centrifuge software. You can tell the centrifuge to echo each character by sending the "**echoon**" command. The user command and the return string of the centrifuge will always be terminated with the characters '0x0A' and '0x0D' (CR and LF).

The command "**cmderror**" can be used to ensure the correct execution of the last command.

The centrifuge outputs a prompt to indicate that it's ready to receive commands. The default prompt is "SIGMA>", but if a name is given to the centrifuge it will be expanded (to give a pc the possibility to distinguish several centrifuges) to "SIGMA xyz>" where "xyz" is the given name.

11 Appendix

V 2. 8

SERIAL CONTROL INTERFACE SPECIFICATION



4.1 Reset message

Centrifuges output a message after reset. Detailed output differs by model, but all models output the reset reason first and output is done when the prompt appears. Reset reasons are:

- ~hwreset
loss of power
- ~wdreset
the watch dog timer forced a reset
- ~exreset
reset by external reset pin
- ~swreset
reset initiated by software

4.2 General user commands

The following categories of user commands are available for all models.

4.2.1 Overview of commands

An overview about available commands is output by sending "?" or "??". Both commands are equal and output of available commands depends on model.

? outputs the command list
?? outputs the command list

4.2.2 Control commands

These commands cause an immediate action.

start starts the centrifuge with the set values
stop stops the centrifuge with the pre-adjusted deceleration
fstop stops the centrifuge with the maximal deceleration
door opens the door (only possible when the rotor is stationary and centrifuge is not equipped with a motor driven hatch/lid, see chapter 4.5.2 Commands for motor driven lid or hatch)
reset resets the centrifuge. This command has the same effect as power-on
reseterr resets an error message of type "Log" and "Warning"

4.2.3 Commands to change the setpoints

Commands to change setpoints (*OUT_SP_n y*)

setspeed or **OUT_SP_1** sets the speed
settemp or **OUT_SP_2** sets the temperature (only centrifuges with cooling/heating)
settime or **OUT_SP_3** sets the runtime

4.2.4 Commands to request process values

Commands to request process values (IN_PV_n)

<i>speed</i>	or	<i>IN_PV_1</i>	requests the actual rotor speed
<i>temp</i>	or	<i>IN_PV_2</i>	requests the actual temperature (only centrifuges with cooling/heating)
<i>time</i>	or	<i>IN_PV_3</i>	requests the remaining time

4.2.5 Commands to request setpoints

Commands to request setpoints (IN_SP_n)

<i>getsetspeed</i>	or	<i>IN_SP_1</i>	requests the set rotor speed
<i>getsettemp</i>	or	<i>IN_SP_2</i>	requests the set temperature (only centrifuges with cooling/heating)
<i>getsettime</i>	or	<i>IN_SP_3</i>	requests the set time

4.2.6 Commands to change parameters

Commands to change parameters (OUT_PAR_n y)

<i>setaccel</i>	or	<i>OUT_PAR_1</i>	sets the acceleration
<i>setdecel</i>	or	<i>OUT_PAR_2</i>	sets the deceleration

For Spincontrol Comfort, Spincontrol Professional, Spincontrol L and Spincontrol S the parameter of these commands is the curve nr to be used for acceleration or deceleration. For Spincontrol universal, Spincontrol easy and Spincontrol basic a "0" sets the soft mode and a "1" sets the normal mode. For setdecel there is also the parameter "-1" which sets the free spinout mode.

4.2.7 Commands to read parameters

Commands to request parameters (OUT_PAR_n)

<i>getaccel</i>	or	<i>IN_PAR_1</i>	requests the acceleration
<i>getdecel</i>	or	<i>IN_PAR_2</i>	requests the deceleration

11 Appendix

V 2 . 8

S E R I A L C O N T R O L I N T E R F A C E S P E C I F I C A T I O N



4.2.8 Commands to request the status

status requests the status of the centrifuge. The value is displayed decimal.

Value	Normal centrifuge or with motor driven lid	Centrifuge with hatch in the lid
0	Rotor is spinning or door is opening / closing.	Rotor is spinning and the centrifuge is not in positioning mode
1	Rotor is stationary: the door can be opened	- Rotor is stationary or - during positioning (not locked) and/or hatch is not open. The hatch can be opened and the rotor is ready for positioning
2	The door is opened	The hatch is open and the rotor is locked. Ready for loading or unloading.
3	An error has occurred	An error has occurred

status1 advanced status of the centrifuge. The value is displayed hexadecimal.

Bit	Status	Normal centrifuge or with motor driven lid	Centrifuge with hatch in the lid
1..0	00	Door is opening/closing	Hatch is opening/closing or undefined or lid is open
	01	Door is open	Hatch is open
	10	Door is close	Hatch is close
	11	Not used	Not used
3..2	00	Wait	Wait
	01	Door can be opened	Hatch can be opened
	10	Door can be closed	Hatch can be closed
	11	Not used	Hatch can be opened or closed
4	0	No imbalance	No imbalance
	1	Centrifuge shut down with imbalance (only set while centrifuge breaks)	Centrifuge shut down with imbalance (only set while centrifuge breaks)
5	0	Rotor is stopped	Rotor is stopped
	1	Rotor is spinning	Rotor is spinning
6	0	No error	No error
	1	Centrifuge shut down with an error	Centrifuge shut down with an error

status2 advanced status of the centrifuge, only centrifuges for roboter placement. The value is displayed hexadecimal.

Bit	Status	Centrifuge with motor driven lid	Centrifuge with hatch in the lid
0	1	Not implemented	Lid is closed
Bit	Status	Centrifuge without bucket lifter unit	Centrifuge with bucket lifter unit
1	0	Always	Bucket is not at its lower end position
	1	Not implemented	Bucket is at its lower end position
2	0	Always	Bucket is not at its upper end position
	1	Not implemented	Bucket is at its upper end position

4.2.9 Other commands

curr Displays all current parameters tabularly: speed, temp (only centrifuges with cooling/heating), status, status1
The optional parameter "/tn" outputs the data continuously where 'n' defines the repeat rate in seconds. Entering a '.' stops monitoring. The parameter are separated by '\t'

Example with 5 seconds repeat rate:

```
curr /t5
speed temp status status1
3017 22 0 0020
3009 22 0 0020
3005 22 0 0020
3003 22 0 0020
3002 22 0 0020
.
```

cmderror Displays the error status of the last command .
The centrifuge returns '1' if no error occurred, '-1' in error case and '0' if no last command status is available.

syserror Displays the error status (current error number) of the centrifuge
The centrifuge returns '0', if no error occurred
In case of error numbers 90, 93 and 95, additional 3 parameters are returned as decimal value with information about states of the servo units (currently only available in models with bucket lifter unit). In detail:

	Parameter 2	Parameter 3	Parameter 4
b15/14 = status of	01 = rotor lock unit	10 = slider unit	11 = bucket lifter unit
b13/12	-	-	-
b11	unknown state	unknown state	unknown state
b10	no catch	-	-
b9	time out slow	time out slow	time out slow
b8	time out fast	time out fast	time out fast
b7	switch error	switch error	switch error
b6	-	-	-
b5	-	over current while closing	-
b4	-	-	-
bit 3 (1 = S4 active)	locked switch	closed switch	up switch
bit 2 (1 = S3 active)	catched switch	nearly closed switch	nearly up switch
bit 1 (1 = S2 active)	-	nearly open switch	nearly down switch
bit 0 (1 = S1 active)	unlocked switch	open switch	down switch

geterr the same as "syserror" (for compatibility with Zent2)

geterrtimeout get the remaining safety timeout in seconds for fatal errors (centrifuges without rotor code). If '0' the centrifuge may be reset by command "reset".

11 Appendix

V 2. 8

SERIAL CONTROL INTERFACE SPECIFICATION



info Displays software version and other service information like this (8K):

```

info
Centrifuge Name: 8K
Part No.: 10855, Version: 001
Device Name: Zent5 Controlboard
Part No.: 70926, Version: 001
Software Part No.: 26490 - Software Version: 009
CompilationDate: Mar 27 2007 (14:16:22)
TotalCycles: 70
TempOffset: -8
ImbalOffset: -1
SIGMA Laborzentrifugen GmbH Osterode
www.sigma-zentrifugen.de
Err      Para      Code      Timestamp
02       10       125       0
15       10       124       0
12       10       100       0
12       8        55        0
02       8        40        0
    
```

or this (2-6):

```

info
Cent:    2-6
PN:      10220
Dev:     2-6 Controlboard
PN:      70925
Ver:     001
SW PN:   26487
SW Ver:  017
comp:    Nov 7 2008 (08:58:05)
    
```

The exact output format of this command may vary between different centrifuge types.

geterrpara Because the error list with all parameters is output by "info" command on models with Spincontrol S and Spincontrol Professional only, for some other models the geterrpara command is implemented which outputs error list with all parameters (implementation depends on software version).

echoon This command activates the character echo. Every character will be echoed and the following messages are sent as acknowledge for every single command:

Return Message	Description
OK	Command successful
CNF	Command not found
NEA	Not enough arguments (e.g. set speed value missing)
ERR	Command not possible
CYCLES	"start" command received but max. cycles of rotor or bucket reached -> start command must be sent again as confirmation to ignore cycles

echooff This command de-activates the character echo.

getcurvelist Optional command. Returns curve list with Curve number, Acceleration in rpm/s, Deceleration in rpm/s, if implemented.

Output format:

```
Curve, Accel, Decel  
0,100,100  
1,1600,1600
```

getrotor Requests the selected rotor by rotor list index.

getrotorlist Optional command. Returns rotor list with Rotor, Bucket, minimum Radius, maximum Radius, maximum Speed and maximum Temperature, if implemented.

Output format:

```
Rotor, Bucket, Rmin, Rmax, Nmax, Tmax  
11037,13035,49,133,4000,40  
11171,13299,38,142,4000,40  
11171,13296,65,133,4000,40  
12072,0,80,139,4000,40  
12073,0,58,139,4000,40
```

setrotor Selects a new rotor by rotor list index.

raoss Shortcut for Runtime As Of Set Speed.
If sent without further parameter, it will be answered by '0' (feature inactive) or '1' (feature activated).
If sent with parameter '0' the feature will be de-activated, if sent with parameter '1' the feature will be activated.

4.3 Additional commands of Spincontrol S and Professional

Models with Spincontrol Professional or Spincontrol S have additional commands.

4.3.1 Commands related to curves

getcurve This command returns the data of a free programmable curve. With the parameter n you can choose the curve between 20 and 29:

11 Appendix

V 2. 8

SERIAL CONTROL INTERFACE SPECIFICATION



```

getcurve 22
CurveNr: 20
Interval 1: Time: 130 Speed: 100 LIN
Interval 2: Time: 60 Speed: 148
Interval 3: Time: 60 Speed: 194
Interval 4: Time: 60 Speed: 257
Interval 5: Time: 60 Speed: 327
Interval 6: Time: 60 Speed: 526
Interval 7: Time: 60 Speed: 800
Interval 8: Time: 30 Speed: 1000
Interval 9: Time: 600 Speed: 100
Interval 10: Time: 40 Speed: 100
TotalTime: 1160
    
```

setcurve This command sets new data for the free programmable curves. The command is followed by the parameter:

setcurve [curveNr],[Lin/Quad],[Int1Time],[Int1Speed] ,[Int2Time],[Int2Speed],etc.

Notice this command is only possible, if no free curve is running!

```

SIGMA>
setcurve 22,0,20,400,20,600,30,630,30,1600,20,2500,30,3200,40,2900,50,3300
OK
SIGMA> getcurve 22
CurveNr: 22
Interval 0: Time: 20 Speed: 400 LIN
Interval 1: Time: 20 Speed: 600
Interval 2: Time: 30 Speed: 630
Interval 3: Time: 30 Speed: 1600
Interval 4: Time: 20 Speed: 2500
Interval 5: Time: 30 Speed: 3200
Interval 6: Time: 40 Speed: 2900
Interval 7: Time: 50 Speed: 3300
Interval 8: Time: 0 Speed: 0
Interval 9: Time: 0 Speed: 0
TotalTime: 240
SIGMA>
    
```

4.3.2 Data of last run

getlastrun This command triggers output of parameters and results of last spin in csv-Format
This command is only available for Spincontrol S.

While there was no spin since last reset, only centrifuge ID, stored barcodes and string "No data available" will be output. Else Data will be output as follows:

Item	1 st column	2 nd column	3 rd column	Condition
Centrifuge ID	Centrifuge name			Always
		not assigned yet		No name assigned

V 2 . 8

SERIAL CONTROL INTERFACE SPECIFICATION



Item	1 st column	2 nd column	3 rd column	Condition
		xy...z		Name assigned 3 rd column is empty
Barcode of data structure "Staff Member Identification Number"	Barcode	Staff Member ID	Barcode content	Barcode exists in memory
Barcodes of data structure "Donation Identification Number"	Barcode	Barcode number (1-12)	Barcode content	One row for each barcode set (0 to 12 rows)
Used program (only Spincontrol S from Version number > 050)	Program	Program number	Program name	Always Existing program used
			Program name Changed during run	Existing program used, but it was changed during run
		- empty column -	RAPID_TEMP	RAPID_TEMP used
			RAPID_TEMP Changed during run	RAPID_TEMP used, but it was changed during run
			--	No program used
Status	Status of run	Completed		Always Run finished already
		Not started		Spin did not start
		Still running		Still running
			Interrupted by error xy	Error during run
			Speed was partly out of setting	Speed error detected by run observation
			Stopped by user	Stop button pressed or shortrun
			Not started	Spin did not start
			Temperature not reached (yet)	Set temperature (still) not reached (only Spincontrol S)
			OK	Run OK
Blank line				Always
Start Time	Start time of last run			Always
		abcd hours, ef minutes, gh seconds ago		Output depends on time since start
			OK Not started	Spin did start Spin did not start
Kind	Kind of last run			Always
		Short run		Short run
		Normal run		Normal run
			Not started	Spin did not start
			OK	Always
Total Time	Total time			Only if started and finished already
		abcd hours, ef minutes, gh seconds		Output depends on total time
			Interrupted OK	Stop button pressed or shortrun Run OK

PAGE 11

11 Appendix

V 2 . 8

SERIAL CONTROL INTERFACE SPECIFICATION



Item	1 st column	2 nd column	3 rd column	Condition
Run Time	Run time	Infinite abcd hours, ef minutes, gh seconds		Only if normal run started
				Run time set to infinite
				Output depends on set run time
			Interrupted	Stop button pressed or error happened
			Changed during run	Parameter was changed during run
			Still running	Still spinning
			OK	Run time OK
Runtime as of Set Speed	Runtime as of set speed	Active		Only if normal run started and Item was used
			Changed during run	Item was changed during run
			OK	Item OK
Deceleration Time	Deceleration time	abcd hours, ef minutes, gh seconds		Only if deceleration time was displayed on screen
				Output depends on deceleration time
			OK	Always
Speed	Speed	abcde 1/min		If started
				Depends on set speed
			Speed was partly out of setting	Speed error detected by run observation
			Not Reached	Set speed was not reached
			Not reached yet	Set speed still not reached
			Changed during run	Set speed was changed during run
			OK	Speed OK
RFC	RCF	abcde *g		If started
				Depends on set RCF
			Speed was partly out of setting	Speed error detected by run observation
			Not Reached	Set RCF was not reached
			Not reached yet	Set RCF still not reached
			Changed during run	Set RCF was changed during run
			OK	RCF OK
Temp	Temperature			Only models with Cooling/Heating if started

V 2 . 8

SERIAL CONTROL INTERFACE SPECIFICATION



Item	1 st column	2 nd column	3 rd column	Condition
		-ab +/- 5 degree Celsius		Output depends on set temperature and set temperature unit, value (+/-5) is modifiable by command setlastruntempdiff from 2 to 8
			Not Reached	Set temperature was not reached
			Not reached yet	Set temperature still not reached
			Changed during run	Set temperature was changed during run
			OK	Temperature OK
Rotor	Rotor			If started
		abcde		Output depends on set rotor
			OK	Always
Bucket	Bucket			Only if started and a rotor with bucket is set
		abcde		Output depends on set bucket
			OK	Always
Acceleration	Acceleration			If started
		Curve 9 (Short run)		Short run
		Curve x		Normal run, output depends on set acceleration curve
			Changed during run	Set acceleration curve was changed during run
			OK	Set acceleration curve unchanged
Deceleration	Brake			If started
		Curve 9 (Short run)		Short run
		Curve x (Quick stop)		Quick stop
		Curve x		Normal run, output depends on set deceleration curve
			Changed during run	Set deceleration curve was changed during run
		Still running	Still spinning	
		OK	Set deceleration curve unchanged	
Spinout	Spinout			Only if normal run started and Item was used (not quick stop)
		From abcd 1/min		Output depends on set Spin out speed
			Changed during run	Item was changed during run
			Still running	Still spinning
		OK	Item OK	

PAGE 13

11 Appendix

V 2 . 8

S E R I A L C O N T R O L I N T E R F A C E S P E C I F I C A T I O N



Item	1 st column	2 nd column	3 rd column	Condition
Integral	Integral	abcxyz	OK	Output (abcxyz) depends on integral (only Spincontrol S)

The columns are separated by semicolon.

4.3.3 Commands related to programs

setpara This command sets all necessary parameters for a centrifugation at once. Because it's implemented to enable scanning all the centrifugation parameters using a 1D barcode scanner, its command parameters are NOT separated by colons as usual (Code128 has max. data length of 48 characters). Therefore setting up the command parameters has to follow this specification strictly, to guaranty setting the centrifugation parameters correctly.

Parameter number	Meaning	Accepted values
1 to 5	Rotor	Only rotors listed in the centrifuges rotor menu are accepted. 5 characters are mandatory, so fill up rotor number with leading zeros if necessary!
6 to 10	Bucket	Only buckets listed in the centrifuges rotor menu are accepted, but only if they fit to the rotor sent in 1 to 5. 5 characters are mandatory, so fill up bucket number with leading zeros if necessary! If a rotor without buckets is used, set to '00000'.
11 to 13	Radius in mm	'000' (=Rmax) and all values from Rmin to Rmax 3 characters are mandatory, so fill up radius with leading zeros if necessary!
14 to 16	Density in g/cm ³ * 10	'012' to '100' (=1.2g/cm ³ to 10.0g/cm ³) 3 characters are mandatory, so fill up density with leading zeros if necessary!
17	's' for speed, 'r' for RCF	's', 'S', 'r', 'R'
18 to 22	Speed or RCF	Speed: '00100' to maximum speed of rotor and density RCF: Minimum to maximum RCF of rotor and radius 5 characters are mandatory, so fill up speed/RCF with leading zeros if necessary!
23	Sign for temperature value	+', '-' (only centrifuges with cooling/heating, ignored else)
24 to 25	Temperature value	Minimum temperature of centrifuge to maximum temperature of rotor (only centrifuges with cooling/heating, ignored else). 2 characters are mandatory, so fill up temperature with leading zeros if necessary!
26 to 31	Run time in seconds	'000000' (infinite run) and '000010' to '359999' 6 characters are mandatory, so fill up time with leading zeros if necessary!
32 to 33	Acceleration curve	'00' to '19' (always) plus '20' to '29' (but only if the corresponding curve is stored in centrifuge). 2 characters are mandatory, so fill up curve number with leading zero if necessary!
34 to 35	Deceleration curve	'00' to '19' (always) plus '20' to '29' (but only if the corresponding curve is stored in centrifuge). 2 characters are mandatory, so fill up curve number with leading zero if necessary!
36 to 37	Spin-out speed * 100rpm	'00' (no spin-out), '01' to '10' (=spin-out speed from 100rpm to 1000rpm). 2 characters are mandatory, so fill up with leading zero if necessary!
38	Flag "runtime as of set speed"	'0', '1'

Due to this, the parameter length is fixed to 38, so the whole command takes 46 characters. If the length is not exactly 46 characters, the command will be ignored.
This command is only available for Spincontrol S.

11 Appendix

V 2. 8

SERIAL CONTROL INTERFACE SPECIFICATION



4.3.4 Other commands

getname Displays name of the centrifuge (given by centrifuge menu Setup System Name).

getprocess This command gives an overview about the currently set process data (rotor number, bucket number, spd in rpm, time in seconds – 0 is endless, temperature in °C [only centrifuges with cooling/heating], acceleration curve number, deceleration curve number) as well as information about rotor spinning (run = 1) or not (run = 0) and if an error appeared (err = 1) or not (err = 0). It also contains a crc (xor all data) to enable check of correct transmission.

```
getprocess
rotor,bucket,spd,time,temp,acc,dec, run, err,crc
11805, 13850, 200, 0, 20, 9, 29, 0, 0, 207
```

4.4 Additional commands of Spincontrol S

getpara This command returns all necessary parameters for a centrifugation at once. It's implemented to enable copying a parameter setting into another centrifuge (in combination with "setpara"). Therefore output is in the same format as expected by command "setpara".
This command is only available for Spincontrol S.

setprog This command is to store the actual centrifugation parameters to a program with the given number and name. Therefore, two parameters are mandatory, separated by comma. First parameter specifies the program number, valid from 1 to 60.
Attention: already stored program on this position will be overwritten!
The second parameter is a string with at least one, but up to 19 ASCII characters and specifies the program name.
This command is only available for Spincontrol S.

getprog This command returns set program number (1 to 60) and program name. It's implemented to copy programs at the same position with the same name on another centrifuge. Therefore output is in the same format as expected by command "setprog". If no program is set, output is "0,-", if RapidTemp is set, output is "0,RapidTemp".
This command is only available for Spincontrol S.

getlibr This command returns all stored user programs, one program per line in format program number (1 to 60), comma, program name, comma and program parameters as returned by command getpara. It's implemented to copy all programs at the same position with the same name and same parameters on another centrifuge. But a corresponding "setlibr" function is not implemented yet.
This command is only available for Spincontrol S.

loadprog This command loads a program of the centrifuge. It's only accepted if no centrifugation is in progress.
One parameter is mandatory and specifies the program to load, where valid programs are:
- 0 (only for centrifuges with refrigerator/heater) = RapidTemp program.
Command is only accepted if
→ set temperature is below actual temperature (centrifuge with refrigerator only)
→ set temperature is above actual temperature (centrifuge with heater only)
→ set temperature is different to actual temperature (centrifuge with refrigerator and heater)
→ never (centrifuge without refrigerator or heater)
- 1 to 60 = corresponding program stored in centrifuge.
Command is not accepted if the program doesn't exist.
This command is only available for Spincontrol S.

- setbarcode** This command adds one barcode (Code128 = ISBT128) to the next centrifugation run. It's possible to add up to 13 barcodes to one run (12 codes of data structure "Donation Identification Number" from blood bags plus 1 code of data structure "Staff Member Identification Number"). The syntax is "setbarcode abc" where abc = content of the barcode. The content of the barcodes is not verified in any matter, only the kind of data structure is checked. Each barcode has to be set separately.
This command is accepted only if
- no centrifugation is in progress and
 - there are no barcodes from an older run in memory (use "deletebarcodes" command to delete them) and
 - Barcode is of data structure "Donation Identification Number" or "Staff Member Identification Number" and
 - same barcode is not already stored and
 - less than 12 barcodes of data structure "Donation Identification Number" are set already if it's a barcode of data structure "Donation Identification Number" and
 - No barcode of data structure "Staff Member Identification Number" is set already if it's a barcode of data structure "Staff Member Identification Number".
- Using this command will also delete all memorized data of the last run (see getlastrun command) to inhibit invalid combination of barcodes with old run data.
If barcode menu is implemented in the centrifuge software, it will come up and display the stored barcodes.
This command is only available for Spincontrol S.
- getbarcodes** This command is always accepted and triggers output of existing barcodes in memory as follows:
"Barcodes abc, def, ghi, ..."
where abc = content of first barcode, def = content of second barcode, ghi = content of third barcode and so on for one up to 12 barcodes of data structure "Donation Identification Number".
If a barcode of data structure "Staff Member Identification Number" is stored, it's output as first barcode with the extension (staff), so output is
"Barcodes abc (staff), def, ghi, ..."
If no barcode is stored, output is
"Barcodes none"
This command is only available for Spincontrol S.
- deletebarcodes** This command deletes all existing barcodes from memory. It's only accepted (even if no barcodes are stored) if no centrifugation is in progress.
If barcode menu is just on display, it will be updated.
This command is only available for Spincontrol S.
- probar** This command returns the status of the displayed Progress Bar. It's intended for use by DataSuite, which displays the actual progress on a PC. It's answer has 2 parameters:
- parameter 1 corresponds to the displayed progress in per cent in decimal,
 - parameter 2 is in hex with following meaning,
 - bits 0-7 are equal to answer to command "getstatus1",
 - bit 8 signals that ProBar is **not** on display,
 - bit 9 signals that ProBar on display is **blinking**.
 - bit 10 signals that set speed/RCF is reached
 - bit 11 signals that set temperature is reached (only centrifuges with temperature control)
- This command is only available for Spincontrol S.

11 Appendix

V 2 . 8

SERIAL CONTROL INTERFACE SPECIFICATION



setlastruntempdiff This command can be used to adjust the temperature alert limit of $\pm 5^{\circ}\text{C}$ to a value of choice between $\pm 2^{\circ}\text{C}$ and $\pm 8^{\circ}\text{C}$. If temperature reaches a value within the limit, centrifuge will send OK to terminal. To adjust temperature alert limit, use command "setlastruntempdiff x" with x being a number between 2 and 8. This command is accepted in standstill only, and with value set between 2 and 8. Modification of the value deletes data of the last run and stores the set temperature difference.

getlastruntempdiff This command returns the currently set temperature window of command getlastrun in degree Celsius. For example a return value of 5 means getlastrun puts out the string "+/- 5 degree Celsius" at column 2 of the temperature item if the set temperature was reached within the window of +/- 5 degree Celsius..

4.5 Commands of centrifuges for robot placement

run n Starts the centrifuge with speed n [rpm].

Note: If the centrifuge is equipped with a hatch in the lid, this command closes the hatch and the centrifuge begins to start the run when the hatch is closed.
If the centrifuge is equipped with a bucket lifter unit, the bucket is moved to its lowest position before the run starts.

4.5.1 Commands for control panel

lock Lock buttons and navigation on control unit (control possible via RS232 only)

unlock Unlock buttons and navigation on control unit

4.5.2 Commands for motor driven lid or hatch

close closes the lid / hatch

door opens the lid / hatch

4.5.3 Commands for rotor positioning

setpos n n=0: unlock the rotor
n>0: go to position n
the lid must be close for positioning

Note: If the centrifuge is running, this command stops the run automatically and the rotor goes to position n. If the centrifuge is equipped with a hatch in the lid, the hatch opens automatically during positioning. If the centrifuge is equipped with a bucket lifter unit, the bucket is moved to its lowest position before positioning starts.

pos Outputs the position of the rotor in positioning mode

4.5.4 Commands for bucket lifter unit

lift move the bucket to its upper end position

Note: The command is not accepted while the rotor is spinning during run or positioning.

release move the bucket to its lower end position

4.5.5 Commands for Rotor Cycle Counter

An additional rotor cycle counter is implemented for free use by the user. This counter can only be read out by serial interface. The maximum count value is 4294967295. The value will be set to 0 in case of overflow.

<i>rcycle</i>	Displays the current rotor cycle counter.	
<i>bcycle</i>	Displays the current bucket cycle counter.	ONLY Spincontrol L
<i>erasercycle</i>	Resets the rotor cycle counter to "0".	ONLY Spincontrol Universal

4.5.6 Commands for Servo Cycle Counters

<i>lifercycles</i>	get cycles of bucket lifter unit
<i>lockcycles</i>	get cycles of rotor lock unit
<i>slidercycles</i>	get cycles of slider unit

11 Appendix

V 2 . 8

SERIAL CONTROL INTERFACE SPECIFICATION



4.6 Table of user commands

The following table contains the available user commands.

Command name	2. name	Parameters	Return values	Unit	Format ¹	Only models with
?	??		list of commands		ASCII	
bcycle			1	cycles	UINT	Robot placement
close						Robot placement
cmderror			1	0, 1, -1 ch. 4.2.9	INT	
curr			4	rpm, °C, status, status1	UINT, INT, UINT, HEX	
deletebarcodes						Spincontrol S
door						
echooff				ch. 4.2.9		
echoon				ch. 4.2.9		
erasercycle						Robot placement and Spincontrol Universal
fstop						
getaccel	IN_PAR_1		1	acc. curve nr	UINT	
getbarcodes			ch. 0	Barcodes	ASCII	Spincontrol S
getcurve		1	ch. 4.3.1	ch. 4.3.1	ch. 4.3.1	Spincontrol Professional, S
getcurvelist			list	see ch. 4.2.9	see ch. 4.2.9	optional
getdecel	IN_PAR_2		1	dec. curve nr	UINT	
geterr	syserror		1 or 4	error	UINT	
geterrpara			list		ASCII	Except Spincontrol Professional, S
getlastrun			ch. 4.3.2	ch. 4.3.2	ch. 4.3.2	Spincontrol Professional, S
getlastruntempdiff			1	Degree Celsius	UINT	Spincontrol S
getlibr			see ch. 4.3.3	see ch. 4.3.3	see ch. 4.3.3	Spincontrol S V051
getname			1	Name	ASCII	Spincontrol Professional, S
getpara			1	see ch. 4.3.3	see ch. 4.3.3	Spincontrol S V051
getprocess			10	see ch. 4.3.4	see ch. 4.3.4	Spincontrol Professional, S
getprog			2	see ch 4.3.3	see ch 4.3.3	Spincontrol S V051
getrotor			1	Rotor List Index	UINT	
getrotorlist			list	see ch. 4.2.9	see ch. 4.2.9	optional

V 2 . 8

SERIAL CONTROL INTERFACE SPECIFICATION



Command name	2. name	Parameters	Return values	Unit	Format ¹	Only models with
getsetspeed	IN_SP_1		1	rpm	UINT	
getsettemp	IN_SP_2		1	°C	INT	Temperature control
getsettime	IN_SP_3		1	sec.	UINT	
info			list	ch. 4.2.9		
lift						Bucket lifter unit
liftercycles			1	cycles	UINT	Bucket lifter unit
loadprog		1		Program number	UINT	Spincontrol Professional, S
lock						Robot placement
lockcycles			1	cycles	UINT	Bucket lifter unit
pos			1	1..4	UINT	Robot placement
probar			2	%, flags	UINT, HEX	Spincontrol S
Raoss		1	1	Feature (in)active	UINT	
rcycle			1	cycles	UINT	Robot placement
release						Bucket lifter unit
reset						
reseterr						
run		1		rpm	UINT	Robot placement
setaccel	OUT_PAR_1	1		acc. curve nr	UINT	
setbarcode		1		Barcode	ASCII	Spincontrol S
setcurve		ch. 4.3.1	ch. 4.3.1	ch. 4.3.1	ch. 4.3.1	Spincontrol Professional, S
setdecel	OUT_PAR_2	1		dec. curve nr	UINT	
setlastruntempdiff		1		Degree Celsius	UINT	Spincontrol S
setpara		1		see ch. 4.3.3	see ch. 4.3.3	Spincontrol Professional, S
setpos		1		1..4	UINT	Robot placement
setprog		2		see ch. 4.3.3	see ch. 4.3.3	Spincontrol Professional, S
setrotor		1		Rotor List Index	UINT	
setspeed	OUT_SP_1	1		rpm	UINT	
settemp	OUT_SP_2	1		°C	INT	Temperature control
settime	OUT_SP_3	1		sec.	UINT	
slidercycles			1	cycles	UINT	Bucket lifter unit
speed	IN_PV_1		1	rpm	UINT	
start						
status			1	ch. 4.2.8	UINT	
status1			1	ch. 4.2.8	HEX	
status2			1	ch. 4.2.8	HEX	Robot placement

PAGE 21

11 Appendix

V 2 . 8

SERIAL CONTROL INTERFACE SPECIFICATION



Command name	2. name	Parameters	Return values	Unit	Format ¹	Only models with
stop						
temp	IN_PV_2		1	°C	INT	Temperature control
time	IN_PV_3		1	sec.	UINT	
unlock						Robot placement

¹ UINT = decimal unsigned integer value; INT = decimal signed integer value; HEX = hexadecimal value

5 Examples

Note: All commands have to be send without quotation marks and brackets!

[CR] and [LF] are ASCII coded control characters (Carriage Return and Linefeed)

setting the setspeed to 1000 rpm:

```
`setspeed 1000[CR][LF]`
```

starting the centrifuge:

```
`start[CR][LF]`
```

requesting the actual rotorspeed:

```
`speed[CR][LF]` answerstring: `1000[CR][LF]`
```

running the centrifuge at 2000 RPM for 2 minutes. Temperature: 5°C:

```
`setspeed 2000[CR][LF]`
```

```
`settemp 5[CR][LF]`
```

```
`settime 120[CR][LF]`
```

```
`start[CR][LF]`
```

requesting the actual status of the centrifuge:

```
`status[CR][LF]` answer string: `0[CR][LF]` (rotor is spinning)
```

or: `1[CR][LF]` (rotor is stationary)

requesting all actual values of the centrifuge:

```
`curr[CR][LF]` answerstring: `speed temp status status1[CR][LF]`  
2000 5 1 0004[CR][LF]`
```

to request the actual parameters periodically you have to put a '/tn' behind the command. The 'n' stands for the repeat rate in seconds. Entering a '.' stops monitoring.

requesting the actual values of the centrifuge periodically every 5 seconds:

```
command: `curr /t5[CR][LF]`
```

```
answer of the centrifuge: `speed temp status status1[CR][LF]`  
2000 5 1 0004[CR][LF]`
```

```
5 seconds later: 2001 5 1 0004[CR][LF]`
```

Stop requesting the actual values of the centrifuge periodically:

```
command: `curr /t.[CR][LF]`
```

11 Appendix

V 2 . 8

S E R I A L C O N T R O L I N T E R F A C E S P E C I F I C A T I O N



6 Hardware interface (optional accessory)

6.1 Pinning of the connector

Pinning of the 9 pin SUB-D (male) connector on the cover of the centrifuge

PIN 2: TxD (transmit)

PIN 3: RxD (receive)

PIN 5: GND (ground)

PIN 1,4,6,7,8,9: Not Connected

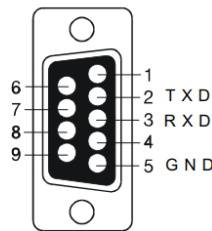

6.2 Typical connection to a PC

Typical connection to a personal computer or a terminal with serial RS232 interface:

9-pin male socket at PC / terminal:

Standard 1:1 serial cable (9 pin female ⇔ 9 pin female)

Required:	PIN 2 ⇔ PIN 2	TxD (Cent.) ⇔ RxD (PC)
	PIN 3 ⇔ PIN 3	RxD (Cent.) ⇔ TxD (PC)
	PIN 5 ⇔ PIN 5	GND (Cent.) ⇔ GND (PC)

25-pin male socket at PC / terminal:

Standard 1:1 serial cable (9 pin female ⇔ 9 pin female) + 9-25 way Adaptor, 9 pin male ⇔ 25 pin female

or

Serial cable (9 pin female ⇔ 25 pin female):

Pin-Pin Configuration (only boldface printed required):

D Sub 9 :	1	2	3	4	5	6	7	8	9
D Sub 25:	8	3	2	20	7	6	4	5	22

Note: Do not use a "Null-Modem" cable/adaptor with crossed RxD/TxD signals

11.7 EC declaration of conformity



EC – DECLARATION OF CONFORMITY

The product named hereinafter was developed, designed, and manufactured in compliance with the relevant, fundamental safety and health requirements of the listed EC directives and norms.

In the event of modifications that were not authorised by us or if the product is used in a manner that is not in line with the intended purpose, this declaration will be rendered void.

<i>Product name:</i>	Laboratory centrifuge
<i>Product type:</i>	Sigma 8KS
<i>Order number:</i>	10630, 10631, 10632, 10633, 91300, 91301, 91367, 91583, 91594, 190010
<i>Directives:</i>	2006/42/EC Machinery Directive 2014/35/EU Low Voltage Directive 2014/30/EU EMC Directive (EU) 2015/863 RoHS Directive
<i>Normes:</i>	EN 61010-2-020:2017 EN 61010-2-011:2017 EN IEC 61000-3-2:2019 EN 61000-3-3:2020 EN 61326-1:2013

Sigma Laborzentrifugen GmbH

An der Unteren Söse 50
37520 Osterode
Germany

Authorised representative
for CE matters:
Eckhard Tödteberg

Osterode, 22/02/2022

Michael Sander
General Manager

11 Appendix

11.8 Declaration of conformity – China RoHS 2



DECLARATION OF CONFORMITY

China RoHS 2 (Administrative Measures for the Restriction of the Use of Hazardous Substances in Electrical and Electronic Products)

Laboratory centrifuge models: Sigma 1-14, 1-14K, 1-7, 1-16, 1-16K, 2-7, 2-16P, 2-16KL, 2-16KHL, 3-16L, 3-16KL, 3-18KS, 3-18KHS, 3-30KS, 3-30KHS, 4-5L, 4-5KL; 4-5KRL, 4-16S, 4-16KS, 4-16KHS, 6-16S, 6-16HS, 6-16KS, 6-16KHS, 8KS, 8KBS

Sigma Laborzentrifugen GmbH has made reasonable effort to avoid the use of hazardous substances in the products it manufactures (laboratory centrifuges).

A Product Conformity Assessment (PCA) was performed in order to determine whether the concentration of harmful substances in all homogeneous materials of the component parts is above or below the MCV limit (Maximum Concentration Value limit) as defined in GB/T 26572:

Mercury and its compounds: 0.1 % Cadmium (Cd) and its compounds: 0.01 %
 Lead (Pb) and its compounds: 0.1 % Hexavalent chromium (Cr (VI)) and its compounds: 0.1 %
 Polybrominated biphenyls (PBB): 0.1 % Polybrominated diphenyl ethers (PBDE): 0.1 %

表1 产品中有害物质的名称及含量
 Table 1: Name and content of hazardous substances in the product

部件名称 Component part (PCA)	有害物质 Hazardous substance					
	铅 Lead (Pb)	汞 Mercury (Hg)	镉 Cadmium (Cd)	六价铬 Hexavalent Chromium (Cr (VI))	多溴联苯 Poly-brominated biphenyls (PBB)	多溴二苯醚 Polybrominated diphenyl ethers (PBDE)
Electronic PCB, cables	X ¹⁾	○	○	○	○	○
Display	○	○	○	○	○	○
Housing	X ²⁾	○	○	○	○	○
Base, metal, accessories	X ²⁾	○	○	○	○	○

本表格依据SJ/T 11364的规定编制。
 This table is made according to SJ/T 11364.

11 Appendix



O: 表示该有害物质在该部件所有均质材料中的含量均在GB/T 26572规定的限量要求以下。
Indicates that the content of the harmful substance in all homogeneous materials of the component part is below the limit as defined in GB/T 26572.)

X: 表示该有害物质至少在该部件的某一均质材料中的含量超出GB/T 26572规定的限量要求。(企业可在此处, 根据实际情况对上表打“X”的技术原因进行进一步说明。)
Indicates that the content of the harmful substance in at least one homogeneous material of the component part exceeds the limit as defined in GB/T 26572. (Contact the manufacturer for further technical information according to the actual situation.)

1) Contains parts in compliance with exemptions 6c, 7c.I, 7c.II and 37 of 2011/65/EU RoHS.

2) Contains parts in compliance with exemptions 6a, 6b and 6c of 2011/65/EU RoHS.

Apart from the exemptions given in this table, none of the substances listed above have been intentionally added to the product or metallic coatings.

Sigma Laborzentrifugen GmbH

An der Unteren Söse 50
37520 Osterode
Germany

Osterode, 08/11/2023

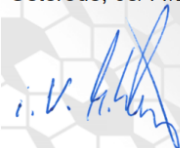

M. Weigoni, Director of Procurement

11.9 UKCA declaration of conformity



UKCA – DECLARATION OF CONFORMITY

The product named hereinafter was developed, designed, and manufactured in compliance with the relevant, fundamental safety and health requirements of the listed directives and norms.

In the event of modifications that were not authorised by us or if the product is used in a manner that is not in line with the intended purpose, this declaration will be rendered void.

<i>Product name:</i>	Laboratory centrifuge
<i>Product type:</i>	Sigma 8KS
<i>Order number:</i>	10631, 91300, 91301, 91583, 10633, 91367
<i>Manufacturer:</i>	Sigma Laborzentrifugen GmbH An der Unteren Söse 50 37520 Osterode am Harz Germany
<i>Directives:</i>	Supply of Machinery (Safety) Regulations 2008 Electrical Equipment (Safety) Regulations 2016 Electromagnetic Compatibility Regulations 2016 Restriction of the Use of Certain Hazardous Substances in Electrical and Electronic Equipment Regulations 2012
<i>Normes:</i>	EN 61010-2-020:2017 EN IEC 61000-3-2:2019 EN 61000-3-3:2020 EN 61326-1:2013

UK Authorised Representative:

**UK
CA** SciQuip Ltd
Newtown
Wem
Shropshire
SY4 5NU

Osterode, 19/10/2022

Michael Sander
General Manager

11 Appendix

12 Index

A

Acceleration	47
Acceleration curve	47, 58, 85
Acceleration curve (changing)	58
Acceleration curve (creating)	58
Accessories	
changes in colour	76
changes in structure	76
deformation of tubes	76
Leaks	76
marking	27
Accessories, cleaning and care	72
Acid	25, 71, 73
Acoustic signal	67
Activating the help function	61
Adapters	39, 40, 72
Alkaline solutions	25, 71, 73
Ambient conditions	82
Ambient temperature	82
Anodised coating	72
Application examples	16
Autoclaving	76
Automatic lid opening function	55
Automatic program rotation	65
Automatic rotor identification	46

B

Barcode commands	60
Barcode menu	59
Barcodes (deleting)	61
Barcodes (reading out)	60
Barcodes (setting)	60
Blocking a function	54
Blood bag systems	40
Brake	47
Brakeless deceleration	47
Brakeless deceleration from set speed	53
Brief mains power failure	67
Bucket	39, 40
Buckets, cleaning and care	73
Buzzer/signal	57

C

Capacity	81
Carrier	39
Carrier systems	39
Carriers, cleaning and care	73
CE mark in compliance with the directive 2006/42/EC	18
Centrifugation monitoring	52
Centrifugation of blood bag systems	40
Centrifugation of infectious, toxic, radioactive, or pathogenic substances	24
Centrifugation principle	16
Centrifugation with low capacity	38
Centrifugation with vessels of various sizes	38
Centrifuge cannot be started	67
Centrifuge decelerates during operation	67
Centrifuge is inclined	67
Centrifuge was moved during run	67
Centrifuge, cleaning and care	71
Centrifuges	
- definition	9
Changes in colour (accessories)	76
Changes in structure (accessories)	76
Changing an acceleration curve	58
Changing the code	54
Chemical and biological safety	24
Chemical resistance of plastic	73
China RoHS 2 – Declaration of conformity	119
Cleaning agents	75
Cleaning the bores of angle rotors	72
Cleaning the centrifuge	71
Closing the lid	23, 34
CO ₂ equivalent	81
Communication error	69
Condensate	32
Condensate drain	32
Condenser dirty	67
Condenser, cleaning and care	72
Cone of the motor shaft	35
Connection of a separate computer	66
Contamination	24, 72

Index

Continuous heat resistance.....	75	E	
Continuous run	45	Earth conductor check	29
Contrast (changing)	62	EC declaration of conformity	11, 117
Control system.....	42	EEPROM error.....	69
Cooling water connection.....	15	Electrical connection	81
Copyright	10	Electrical safety.....	23
Corrosion	23, 26, 39, 71, 72, 73, 75	Emergency lid release	68
Cost estimate.....	78	Error correction	67
Cracking	72	Error message	67
Cracks	73	Executing a program.....	64
Creating an acceleration curve.....	58	Explanation of the symbols and notes.....	19
Curve menu	58	Explosive substances	24
Cycles.....	57	External signal	57
D		F	
Damage of the surface.....	73	Fastening stud	35
Dangerous goods.....	25	Filling quantity (refrigerant)	81
Dangerous materials.....	75	Fire preventions	24
Data of the last centrifugation run (reading out).....	61	Flow rate (water cooling system).....	81
Date of manufacture	15	Form for the return of defective parts	78
Deactivating the help function	61	Function.....	55
Deceleration (brake)	47	Functional and operating elements	12
Deceleration curve.....	47, 58, 85	Further applicable documents.....	9
Declaration of conformity	11, 117	Fuses have tripped	67
Declaration of conformity – China RoHS 2119		G	
Declaration of decontamination.....	78, 80	General conditions.....	10
Decontamination agent	72, 75	Glass breakage.....	75
Deformation of tubes (accessories).....	76	Glass particles	75
Deleting a program	64	Global warming potential (GWP).....	81
Deleting the stored barcodes	61	Gravitational field	81
Density.....	15, 25, 52	Grease for load-bearing bolts.....	71, 74
Dialog box.....	29	GWP (Global warming potential).....	81
Different service life of rotors and accessories	26, 41, 87	H	
Direct hazard to the life and health.....	19	Hazard warnings.....	9, 10, 39
Directive 2002/96/EC	80	Heater.....	44
Disinfectants	75	Heavy-duty grease for load-bearing bolts... 74	
Disinfection of the rotor chamber and accessories	75	Help function.....	61
Display.....	42, 56	Highly corrosive substances	24
Display deceleration time	56	I	
Disposal of the centrifuge.....	80	Imbalance	38, 39, 40
Disposal of the packaging	80	Imbalance error.....	69
Draining the condensate off	32	Imbalance monitoring system	29
Drive problem	67	Importance of the operating manual.....	9
		Important information	19

Improper loading	67	Marking of the unit	18
Infectious substances	75	Maximum speed for tubes	40
Inflammable substances	24	Measures in the event of hazards and accidents	30
Informal safety instructions	22	Mechanical safety	23
Initial start-up	34	Menu Barcode	59
Inlet pressure (water cooling system)	81	Menu Curve	58
Input fuse	81	Menu Help	61
Inspection by the manufacturer	77	Menu Parameters	51
Installation of a rotor	35	Menu Processlibrary	50
Installation of accessories	38	Menu Setup	55
Installation of an angle rotor with a hermetic lid	37	Menu Standard	44
Installation of rotors and accessories	35	Mode of operation	16
Insufficiently greased load-bearing bolts	74	Modification mode active	43
Intended use	9	Motor error	69
Interrupting a centrifugation run	43	Motor shaft	71
Interrupting a deceleration process	43	Multiple carrier	39
Invert	56	N	
IP code	81	Name plate	15
K		No indication on the display	67
Kinetic energy	15, 81	No power in the mains supply	67
L		Noise level	81
Language	56	Nominal voltage	15
Layout of the centrifuge	12	Notes on safety and hazards	9
Leaks (accessories	76	O	
Lid cannot be opened	67	Online download of forms	79
Lid error	69	Open lid after run	55
Lid lock device	29	Opening the lid	34
Lid lock has not released	67	Operating personnel	21
Lid seal sticks	67	Operational safety of the accessories	72
Lifting and carrying rotors	26	Option for the input and output of data	57
Limit "Delta T"	53	Option: Barcode menu	59
Linear curves	85	Options for data input and output	66
Loading a process	50	Overseas shipping	31
Loading a program	63	P	
Lock	54	Parameter error	69
M		Parameters menu	51
Mains power switch off	67	Pathogenic substances	24, 71, 75
Mains voltage	23	Plastic accessories, cleaning and care	73
Maintenance	71	Potential hazard to the life and health	19
Malfunctions and error correction	67	Potentially hazardous situation	19
Manual mode	43	Power consumption	15, 81
Manufacturer	81	Power cord is not plugged in	67
Marking of rotors and accessories	27	Pressure (refrigerant)	81

Index

Pressure marks.....	73	Rotors, cleaning and care	73
Prevention of accidents.....	9	Runtime	45
Problem description	78	Runtime as of set speed	55
Process.....	51	S	
Process error	69	Safety area	25
Process library	50	Safety devices	29
Program "RAPID_TEMP"	47	Safety distance	23
Program list.....	47, 63, 64	Safety instructions.....	9, 39
Program mode	62	Safety instructions concerning the centrifugation process	25
Program rotation	55	Safety of rotors and accessories	27
Progress indicator	49	Safety range	25
Protection class	81	Safety, chemical and biological	24
Q		Safety, electrical	23
Quadratic curves.....	85	Safety, mechanical.....	23
Qualified electrician.....	21	Safety-conscious work	20
Quick stop.....	43	Saving a program.....	63
R		Scope of supply	11
Radioactive substances	24, 71	Selection, display, and modification of data	43
Radius	17, 51	Serial number	15, 70, 77
RAPID_TEMP program.....	47	Service.....	77
RCF	44	Service contact	70
Reading out the data of the last centrifugation run.....	61	Service life	71
Reading out the stored barcodes	60	Service life of rotors and accessories.....	26, 41, 87
Refrigerant.....	81	Service life of the accessories.....	76
Refrigerant data	81	Service life of the adapter for blood bags no. 13867	41
Relative centrifugal force (RCF)	17, 44	Service work	77
Remove glass particles and metal dust from the rotor chamber	75	Setting a barcode.....	60
Removing the rotor	37	Set-up and connection	32
Requirements concerning the personnel....	21	Setup menu	55
Responsibility of the operator.....	20	Short run.....	45
Return of centrifuges, spare parts, or accessories	78	Solvents.....	25, 71, 73
Return of defective parts	78	Sound signal	29
Rotor chamber	71	Sound signal (warning)	57
Rotor identification, automatic.....	46	Spare part enquiries.....	70
Rotor monitoring system	29	Special equipment: water cooling system ..	81
Rotor radii	83	Specialised personnel.....	21
Rotor selection list.....	46	Speed	15, 17, 44, 81
Rotor tie-down screw	73	Speed/RCF fine	56
Rotors		Speed-gravitational-field-diagram	84
marking.....	27	Speedometer error.....	69
Rotors and accessories with a different service life	26, 41, 87	Spin-out from set speed.....	53
		Standard menu	44

Index

Standards and regulations	10	Temperature inside the rotor chamber	29
Standstill cooling	51	Temperature monitoring	53
Standstill monitoring system	29	Temperature monitoring system	29
Start delay	56	Temperature range	81
Starting a centrifugation run	43	Temperature unit	56
Starting a process	50	Temperature value not reached	67
Sterilisation of the rotor chamber and accessories	75	Thermal stress	71
Stopping of the centrifuge due to an imbalance	74	Time fine	56
Storage and transport	31	Time range	81
Storage conditions	31	Toxic substances	24, 71
Storage locations	81	Tubes	40
Stress-corrosion		Two-finger-principle (rotor fastening)	35
see		Type	15, 81
corrosion	73	Type of the centrifuge	70, 77
Structural changes	24	U	
Supporting rings	40	UKCA declaration of conformity	121
Switching the centrifuge off	66	Unblocking a function	54
Switching the centrifuge on	34	Ungreased load-bearing bolts	67
System	57	Useful volume	
System check	29	- volume that is stated for the tube	39
System error	67, 69	User interface	42
T		Using smaller blood bag systems	40
Table of error codes	69	UV radiation	71
Table of rotors and accessories with a different service life	26, 41, 87	V	
Tap connections (water cooling system)	81	Vessels	39
Technical data	81	Vessels of various sizes	38
Technical documentation	82	W	
Temperature	44	Warning signal	57
Temperature at water inlet	81	Warranty and liability	10
Temperature error	69	Water cooling system	81
		Wear	77