



Sigma 6-16HS

from serial no. 145876



Laboratory Centrifuge
with Heating System

Operating Manual

Please retain for later use!

© Copyright by
Sigma Laborzentrifugen GmbH
An der Unteren Söse 50
37520 Osterode am Harz
Germany

Tel.: +49 (0) 5522 / 5007-0
Fax: +49 (0) 5522 / 5007-12
Web: www.sigma-zentrifugen.de
E-mail: info@sigma-zentrifugen.de

1	General information	9
1.1	Importance of the operating manual	9
1.2	Intended use	9
1.3	Warranty and liability	9
1.4	Copyright	10
1.5	Standards and regulations	10
1.6	Scope of Supply	10
2	Layout and mode of operation	11
2.1	Layout of the centrifuge	11
2.1.1	Functional and operating elements	11
2.1.2	Name plate	12
2.2	Mode of operation	13
2.2.1	Centrifugation principle	13
2.2.2	Area of application	13
2.2.2.1	Speed, radius, and relative centrifugal force	14
2.2.2.2	Density	14
3	Safety	15
3.1	Marking of the unit	15
3.2	Explanation of the symbols and notes	16
3.3	Responsibility of the operator	17
3.4	Requirements concerning the personnel	18
3.5	Informal safety instructions	19
3.6	Safety instructions	20
3.6.1	Electrical safety	20
3.6.2	Mechanical safety	20
3.6.3	Fire prevention	21
3.6.4	Chemical and biological safety	21
3.6.5	Safety instructions for centrifugation	22
3.6.6	Resistance of plastics	22
3.6.7	Safety of rotors and accessories	23
3.6.7.1	Marking of rotors and accessories	23
3.6.7.2	Service life of rotors and accessories	24
3.6.7.3	Service life of the Sigma "Comfort" rotor coating	25
3.7	Safety devices	27
3.7.1	Lid lock device	27
3.7.2	Standstill monitoring system	27
3.7.3	System check	27
3.7.4	Earth conductor check	27
3.7.5	Imbalance monitoring system	27
3.7.6	Temperature monitoring system	27
3.7.7	Rotor monitoring system	27
3.8	Measures in the event of hazards and accidents	28
3.9	Remaining hazards	28

Table of contents

4	Storage and transport	29
4.1	Dimensions and weight.....	29
4.2	Storage conditions	29
4.3	Notes on transport	29
4.4	Packaging.....	30
4.5	Transport safety device.....	30
5	Set-up and connection	32
5.1	Installation site	32
5.2	Power supply	32
5.2.1	Type of connection	32
5.2.2	Customer-provided fuses.....	33
6	Using the centrifuge	34
6.1	Initial start-up	34
6.2	Switching the centrifuge on	34
6.2.1	Opening and closing the lid.....	34
6.2.2	Installation of rotors and accessories	35
6.2.2.1	Installation of a rotor	35
6.2.2.2	Installation of an angle rotor with a hermetic lid.....	36
6.2.2.3	Installation of accessories	38
6.2.2.4	Adapters	40
6.2.2.5	Vessels	40
6.2.2.6	Blood bag systems.....	41
6.2.2.7	Centrifugation with tubes for mineral oil	42
6.3	Control system "Spincontrol S"	43
6.3.1	User interface	43
6.3.2	Manual mode.....	44
6.3.2.1	Starting a centrifugation run	44
6.3.2.2	Interrupting a centrifugation run	44
6.3.2.3	Interrupting a deceleration process	44
6.3.2.4	Selection, display, and modification of data.....	44
6.3.2.5	Standard menu	45
6.3.2.6	Process library menu	51
6.3.2.7	Parameters menu	52
6.3.2.8	Setup menu	56
6.3.2.9	Curve menu	59
6.3.2.10	Help menu	60
6.3.2.11	Changing the contrast.....	61
6.3.3	Program mode.....	61
6.3.3.1	Saving a program.....	62
6.3.3.2	Loading a program.....	62
6.3.3.3	Executing a program.....	63
6.3.3.4	Deleting a program	63
6.3.3.5	Automatic program rotation	64
6.3.4	Options for data input and output.....	65

Table of contents

6.4	Switching the centrifuge off	65
7	Malfunctions and error correction	66
7.1	General malfunctions	66
7.1.1	Emergency lid release	67
7.2	Table of error codes.....	68
7.3	Service contact	69
8	Maintenance and service.....	70
8.1	Maintenance	70
8.1.1	Centrifuge	70
8.1.2	Accessories	71
8.1.2.1	Plastic accessories	71
8.1.3	Rotors, buckets and carriers	72
8.1.3.1	Load bearing bolts	73
8.1.4	Glass breakage	74
8.2	Sterilisation and disinfection of the rotor chamber and accessories	74
8.2.1	Autoclaving.....	75
8.3	Service	76
8.4	Return of defective centrifuges or parts	77
9	Disposal.....	79
9.1	Disposal of the centrifuge	79
9.2	Disposal of the packaging.....	79
10	Technical data.....	80
10.1	Ambient conditions	80
10.2	Technical documentation	81
11	Appendix	82
11.1	Range of accessories	82
11.1.1	Rotor radii.....	82
11.2	Speed-gravitational-field-diagram	83
11.3	Acceleration and deceleration curves	84
11.4	Table of the service life of rotors and accessories.....	86
11.5	Resistance data	87
11.6	EC declaration of conformity	91
11.7	Declaration of conformity – China RoHS 2.....	93
11.8	UKCA declaration of conformity	95
12	Index	97

Table of contents

1 General information

1.1 Importance of the operating manual

A fundamental requirement for the safe and trouble-free operation of the centrifuge is to be familiar with the fundamental safety instructions and all possible hazards.

The operating manual includes important information concerning the safe operation of the centrifuge.

This operating manual and, in particular, the notes on safety and hazards must be observed by all persons operating the centrifuge.

In addition, the local rules and regulations for the prevention of accidents must be complied with.

1.2 Intended use

Centrifuges are power-driven machines that separate liquids from solid matter, liquid mixtures, or solid mixtures by centrifugal force. They are solely intended for this purpose. Any other use beyond this area of application is regarded as improper use. Sigma Laborzentrifugen GmbH cannot be held liable for any damage resulting from such improper use.

The intended use also includes

- observation of all the notes and instructions included in the operating manual and
- compliance with the care, cleaning, and maintenance instructions.

1.3 Warranty and liability

The warranty and liability are subject to our "General Conditions" that were distributed to the operator upon the conclusion of the contract.

Warranty and liability claims are excluded if they are due to:

- improper use.
- non-compliance with the safety instructions and hazard warnings in the operating manual.
- improper installation, start-up, operation, or maintenance of the centrifuge.

1 General information

1.4 Copyright

The copyright concerning the operating manual remains with Sigma Laborzentrifugen GmbH.

The operating manual is solely intended for the operator and their personnel. It includes instructions and information that must not be

- duplicated,
- distributed, or
- communicated in any other way.

Non-compliance may be prosecuted under criminal law.

1.5 Standards and regulations

These operating instructions have been created in accordance with the relevant European standards and regulations (see chapter 11.6 - "EC declaration of conformity").

1.6 Scope of Supply

The centrifuge comprises:

- | | |
|----------------------------------------------------------|------------------|
| • 1 rotor wrench, size 13 | Part no. 930 102 |
| • 1 hexagon socket wrench (size 5) | Part no. 930 051 |
| • 1 tube (30 g) heavy-duty grease for load-bearing bolts | Part no. 71 401 |

Documentation

Operating manual incl. EC declaration of conformity (see chapter 11.6 - "EC declaration of conformity")

Accessories

according to your order, our order confirmation, and our delivery note.

2 Layout and mode of operation

2.1 Layout of the centrifuge

2.1.1 Functional and operating elements

- 1 Lid
- 2 User interface (see chapter 6.3.1 - "User interface")
- 3 Mains switch



Fig. 1: Total view of the centrifuge

- 4 Name plate (see chapter 2.1.2 - "Name plate")
- 5 Fuse holder
- 6 Mains cable

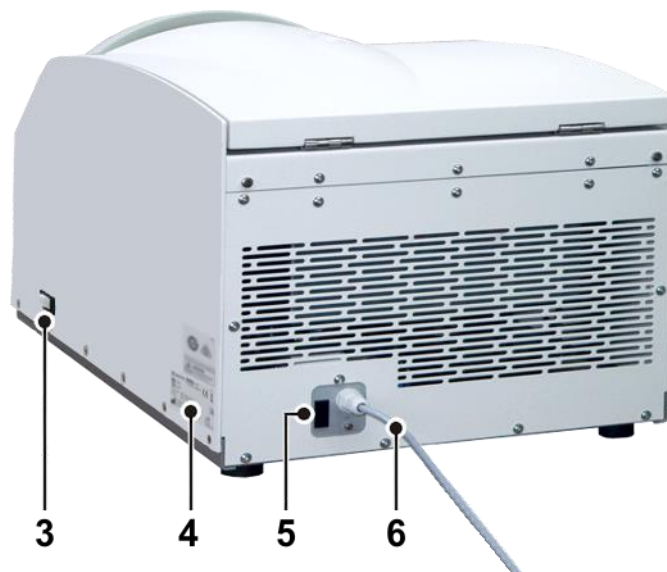

Fig. 2: Rear view of the centrifuge

2 Layout and mode of operation

2.1.2 Name plate

- 1 Manufacturer
- 2 Power consumption
- 3 Max. speed
- 4 Max. kinetic energy
- 5 Serial number
- 6 Part number
- 7 Nominal voltage
- 8 Type
- 9 Consult operating manual
- 10 Symbol for special disposal (see chapter 9 - "Disposal")
- 11 Date of manufacture
- 12 CE mark in compliance with the directive 2006/42/EC
- 13 Max. permissible density

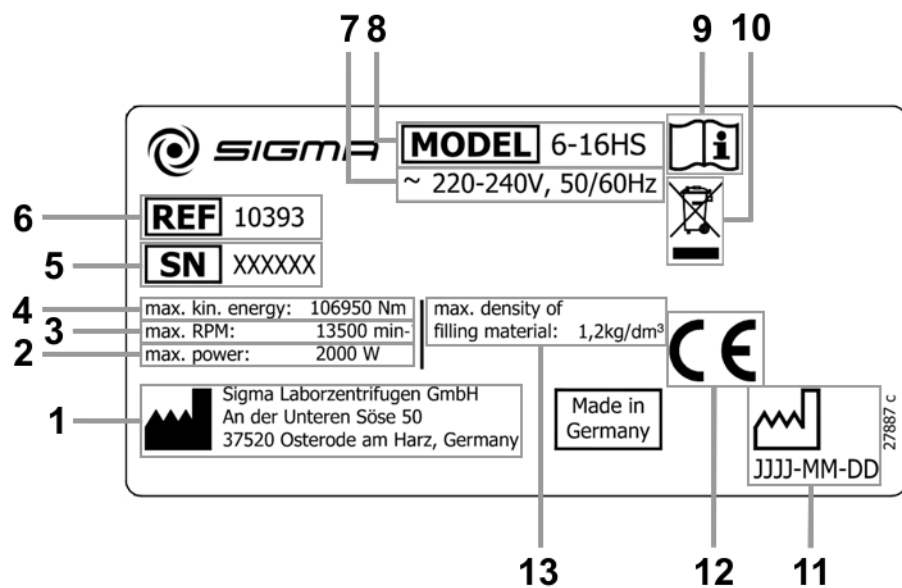

Fig. 3: Example of a name plate

2.2 Mode of operation

2.2.1 Centrifugation principle

Centrifugation is a process for the separation of heterogeneous mixtures of substances (suspensions, emulsions, or gas mixtures) into their components. The mixture of substances, which rotates on a circular path, is subject to centripetal acceleration that is several times greater than the gravitational acceleration.

Centrifuges use the mass inertia inside the rotor chamber for separating the substances. Due to their higher inertia, particles or media with a higher density travel outwards. In doing so, they displace the components with a lower density, which in turn travel towards the centre.

The centripetal acceleration of an object inside a centrifuge, as the effect of centripetal force, depends on the distance between the object and the axis of rotation as well as on the angular velocity. It increases linearly as a function of the distance with regard to the axis of rotation and quadratically as a function of the angular velocity. The bigger the radius in the rotor chamber is and the higher the speed is, the higher the centripetal acceleration is. However, the forces acting on the rotor also increase.

2.2.2 Area of application

Depending on the area of application of the centrifuge and also on the particle size, solids content, and volume throughput of the mixture of substances that is to be centrifuged, there are different types of centrifuges. The areas of application go from household use as a salad spinner or honey separator up to specialised technical applications in the clinical, biological, or biochemical context:

- For numerous clinical examinations, cellular material must be separated from the liquid to be analysed. The normal separation process can be sped up considerably by using laboratory centrifuges.
- In the metal-working industry, centrifuges are used for separating oil from metal cuttings. Dairies use centrifuges in order to separate cow's milk into cream and low-fat milk.
- Particularly big centrifuges are used in the sugar industry for separating the syrup from the crystalline sugar.
- Ultracentrifuges are predominantly used in biology and biochemistry in order to isolate particles, e.g. viruses. They are specifically designed for high speeds up to 500,000 rpm. The rotor moves in a vacuum in order to avoid air friction.

2 Layout and mode of operation

2.2.2.1 Speed, radius, and relative centrifugal force

The acceleration g , which the samples are subject to, can be increased by increasing the radius in the rotor chamber and by increasing the speed. These three parameters are interdependent and linked with each other via the following formula:

$$\text{Relative centrifugal force RCF} = 11.18 \times 10^{-6} \times r \times n^2$$

r = radius in cm

n = speed in rpm

RCF without any dimension

If two values are entered, the third value is determined by way of the stated formula. If, afterwards, the speed or the radius is changed, the resulting relative centrifugal force will be recalculated automatically by the control unit. If the RCF is changed, the speed will be adapted while the specified radius is maintained.

The speed-gravitational-field-diagram provides an overview of the relationship between speed, radius, and RCF (see chapter 11.2 - "Speed-gravitational-field-diagram").

2.2.2.2 Density

The laboratory centrifuge is suitable for the separation of constituents of different densities in mixtures with a maximum density of 1.2 g/cm^3 . All information concerning the speed of rotors and accessories refers to liquids with a density corresponding to this specification. If the density is above this value, the maximum permissible speed of the centrifuge must be reduced based on the following formula:











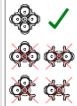

$$n = n_{max} \times \sqrt{(1.2/\rho)}$$

ρ = density in g/cm^3

3 Safety

3.1 Marking of the unit

The following symbols are used on this centrifuge:

 <p>On (Power)</p>	 <p>Arrow indicating the direction of rotation</p>
 <p>Off (Power)</p>	 <p>Rotor loading information (see chapter 6.2.2.3 - "Installation of accessories")</p>
 <p>Centrifuge with heating system</p>	 <p>Name plate (see chapter 2.1.2 - "Name plate")</p>
 <p>Hot surface</p>	 <p>Do not dispose as part of domestic waste</p>
 <p>CE mark in compliance with the directive 2006/42/EC</p>	 <p>RCM mark (only for Australia)</p>
 <p>Consult operating manual</p>	 <p>California Proposition 65 mark (only for the USA)</p>
 <p>China RoHS 2 mark (only for China)</p>	 <p>UKCA mark (only for UK)</p>

i
NOTE

Safety indications on the centrifuge must be kept readable at all times. If necessary, they must be replaced.

i
NOTE

The marking varies depending on the version and country of destination of the centrifuge.

3 Safety

3.2 Explanation of the symbols and notes

In this operating manual, the following names and symbols to indicate hazards are used:



This symbol stands for a **direct** hazard to the life and health of persons.

Non-observance of these symbols **causes** serious health problems up to life-endangering injuries.



This symbol stands for a **direct** hazard to the life and health of persons due to electrical voltage.

Non-observance of these symbols **causes** serious health problems up to life-endangering injuries.



This symbol stands for a **potential** hazard to the life and health of persons.

Non-observance of these symbols **can** cause serious health problems up to life-endangering injuries.



This symbol indicates a potentially hazardous situation

Non-observance of these notes can cause minor injuries or damage to property.



This symbol indicates important information.

3.3 Responsibility of the operator

The operator is responsible for authorising only qualified personnel to work on the centrifuge (see chapter 3.4 - "Requirements concerning the personnel").

The areas of responsibility of the personnel concerning the operation, maintenance, and care of the unit must be clearly defined.

The safety-conscious work of the personnel in compliance with the operating manual and the relevant EC and national health and safety regulations as well as with the accident prevention regulations must be checked at regular intervals (e.g. every month).

Under the international rules for health and safety at work, the operator is obliged to:

- take measures in order to prevent all danger to life or health during work.
- ensure that centrifuges are operated properly and entirely as intended (see chapter 1.2 - "Intended use").
- take protective measures against fire and explosion when working with hazardous substances.
- take measures for the safe opening of centrifuges.

The operator must perform a risk assessment concerning potential accidents in connection with the centrifuge and take design-related countermeasures, if necessary.

The centrifuge has to be maintained regularly (see chapter 8 - "Maintenance and service").

Components that are not in a perfect state must be replaced immediately.

3 Safety

3.4 Requirements concerning the personnel



DANGER

Risk of injury if the personnel are not sufficiently qualified

If unqualified personnel perform work on the centrifuge or are present in the danger zone of the centrifuge, hazards result that can cause serious injuries and considerable damage to property.

- Ensure that all the tasks are performed by personnel with the corresponding qualifications.
- Ensure that unqualified personnel stay clear of the danger zones.



DANGER

Risk of fatal injury to unauthorised persons due to hazards in the danger zone or work area

Unauthorised persons who do not fulfil the requirements described herein are not aware of the hazards in the work area. This is why there is a risk of serious or even fatal injuries for unauthorised persons.

- Ensure that unauthorised persons stay clear of the danger zone and work area.
- If in doubt, address these persons and instruct them to leave the danger zone and work area.
- Interrupt any running work if unauthorised persons are present in the danger zone or work area.

This manual uses the following personnel qualifications for various areas of activity:

Qualified electrician

Due to their special training, knowledge, experience and familiarity with the relevant standards and regulations, qualified electricians are in the position to perform work on electrical systems and to autonomously identify and prevent possible hazards.

Qualified electricians have been specifically trained for the environment in which they work and they are familiar with all the relevant standards and regulations.

Qualified electricians must fulfil the requirements as set out in the applicable legal provisions concerning the prevention of accidents.

Specialised personnel

Due to their special training, knowledge, experience and familiarity with the relevant regulations, specialised personnel are in the position to perform any tasks assigned to them and to autonomously identify and prevent possible hazards.

Operating personnel

Only trained, specialised personnel are authorised to operate the unit. The persons operating the unit must

- be familiar with the fundamental health, safety, and accident prevention regulations,
- have read and understood this operating manual, in particular the safety sections and warning notes, and confirmed this with their signature,
- have been instructed in the operation and maintenance of this centrifuge.

3.5 Informal safety instructions

- This operating manual is a part of the product.
- The operating manual must be kept at the location of use of the centrifuge. Ensure that it is accessible at all times.
- The operating manual must be handed over to any subsequent owner or operator of the centrifuge.
- Any changes, additions or updates received must be added to the operating manual.
- In addition to the operating manual, the general and local rules and regulations concerning the prevention of accidents and the protection of the environment must also be supplied.
- Safety and danger indications on the centrifuge must be kept readable at all times. If necessary, they must be replaced.

3 Safety

3.6 Safety instructions

3.6.1 Electrical safety

As protection against electric shock, the centrifuge is equipped with an earthed mains power cable and connector. To ensure the effectiveness of this safety feature, the following must be ensured:



DANGER

- Ensure that the wall socket is properly wired and grounded.
- Check that the mains voltage agrees with the nominal voltage listed on the name plate.
- Ensure that the mains power cable is intact prior to using the centrifuge. Damaged or faulty mains power cables must be replaced immediately.
- Do not place vessels containing liquid on the centrifuge lid or within the safety distance of 30 cm around the centrifuge. Spilled liquids may get into the centrifuge and damage electrical or mechanical components.
- Only qualified and specialised personnel are authorised to perform service tasks or repairs of the electrical system for which the housing needs to be removed.
- Inspect the electrical equipment of the unit regularly. Defects such as loose or burnt cables must be eliminated immediately.
- Following the completion of any type of repair or service, the qualified and specialised personnel must perform final inspection and testing in compliance with the relevant standards.

3.6.2 Mechanical safety

In order to ensure the safe operation of the centrifuge, observe the following:



WARNING

- Do not open the lid when the rotor is in motion!
- Do not reach into the rotor chamber when the rotor is in motion!
- Do not use the centrifuge if it was installed incorrectly.
- Do not use the centrifuge without panels.
- Do not use the centrifuge if the rotors and inserts show signs of corrosion or other defects.
- Only use the centrifuge with rotors and accessories that have been approved by the manufacturer. In case of doubt, contact the manufacturer (see chapter 7.3 - "Service contact").
- Do not hold your fingers between the lid and the housing when closing the lid. Risk of crushing!
- Defective lid relieving devices could cause the centrifuge lid to fall (contact the service department, if necessary). Risk of crushing!
- Do not hit or move the centrifuge during its operation.
- Do not lean against or rest on the centrifuge during its operation.

**WARNING**

- Do not spin any substances that could damage the material of the rotors and buckets of the centrifuge in any way. Highly corrosive substances, for example, damage the material and affect the mechanical strength of the rotors and buckets.
- Stop the centrifuge immediately in the event of a malfunction. Eliminate the malfunction (see chapter 7 - "Malfunctions and error correction") or inform the service department of the manufacturer (see chapter 7.3 - "Service contact").
- Ensure that all repairs are performed only by authorised and specialised personnel.
- Prior to any start-up, check the centrifuge, rotor, and accessories for signs of damage that can be discerned from the outside. Special attention must be paid to all of the rubber parts (e.g. motor cover, lid seal, and adapters) in terms of visible structural changes. Defective parts must be replaced immediately.
- Open the centrifuge when it is not in use so that moisture can evaporate.

3.6.3 Fire prevention

**DANGER**

- Do not spin explosive or inflammable substances.
- Do not use the centrifuge within hazardous locations.

3.6.4 Chemical and biological safety

If pathogenic, toxic, or radioactive samples are intended to be used in the centrifuge, it is in the responsibility of the user to ensure that all necessary safety regulations, guidelines, precautions, and practices are adhered to accordingly.

**DANGER**

- Infectious, toxic, pathogenic, and radioactive substances may only be used in special, certified containment systems with a bio-seal in order to prevent the material from being released.
- Take suitable precautions for your own safety if there is a risk of toxic, radioactive, or pathogenic contamination
- Materials that chemically react with each other with a high level of energy are prohibited.

**WARNING**

- Keep informed about local measures to avoid harmful emissions (depending on the substances to be centrifuged).
- Protective clothing is not required for the operation of the centrifuge. The materials to be centrifuged may, however, require special safety measures (e.g. centrifugation of infectious, toxic, radioactive, or pathogenic substances).

3 Safety

3.6.5 Safety instructions for centrifugation

For safe operation, observe the following before starting the centrifuge:



WARNING

- Ensure that the centrifuge was set up properly (see chapter 5 - "Set-up and connection").
- Keep a safety range of at least 30 cm free around the centrifuge as well as with regard to walls and other devices.
- Do not store any dangerous goods in the centrifuge area.
- Do not stay in the safety area longer than what is absolutely necessary for the operation of the centrifuge.
- Only use the centrifuge with rotors and accessories that have been approved by the manufacturer. We explicitly warn against the use of equipment of poor quality. Breaking glass or bursting vessels can cause dangerous imbalances at high speeds.
- Ensure that the rotor and buckets are correctly fitted (see chapter 6.2.2.1 - "Installation of a rotor").
- Observe the instructions on the installation of accessories (see chapter 6.2.2.3 - "Installation of accessories").
- The rotor must be loaded in a rotationally symmetrical manner at equal weights.
- If liquids with a density $> 1.2 \text{ g/cm}^3$ are used, reduce the speed (see chapter 2.2.2.2 - "Density").
- Do not use the centrifuge if the rotor is loaded asymmetrically.
- Do not use the centrifuge with tubes that are excessively long.

3.6.6 Resistance of plastics

Chemical influences have a strong effect on the polymeric chains of plastics, and, therefore, on their physical properties. Plastic parts can be damaged if solvents, acids, or alkaline solutions are used.



NOTE

- Refer to the resistance data (see chapter 11.5 - "Resistance data")!

3.6.7 Safety of rotors and accessories

3.6.7.1 Marking of rotors and accessories

Batch number and serial number

During production, every rotor and bucket receives a batch number enabling conclusions to be drawn concerning the production process and the subsequent quality inspection.

Some rotors also have an additional serial number providing further detailed information.

The batch number and serial number is engraved on the rotor as follows:

- 1 Batch number
- 2 Serial number



Fig. 4: Rotor with an engraved batch number and serial number (example)



If there are any enquiries concerning the rotor, please state the batch number and serial number!

Marking of the service life of rotors and accessories

see chapter 3.6.7.2 - "Service life of rotors and accessories"

Marking of rotors with Sigma "Comfort" rotor coating

see chapter 3.6.7.3 - "Service life of the Sigma "Comfort" rotor coating"

3 Safety

3.6.7.2 Service life of rotors and accessories

The rotors and accessories have a limited service life.



WARNING

- Perform regular checks (at least once per month) for safety reasons!
- Pay special attention to changes, such as corrosion, cracks, material abrasion, etc.

- After 10 years, they must be inspected by the manufacturer.
- After 50,000 cycles, the rotor must be scrapped for reasons of safety.
- If other data concerning the service life are engraved on the rotor or bucket, these data shall apply accordingly. For example, a bucket with the engraving "max. cycles = 10,000" has a service life of 10,000 cycles, and a rotor with the engraving "Exp. date 01/27" must be scrapped in January 2027 at the latest (see figure).
- If a specification concerning the maximum number of cycles **and** a specification concerning the service life (i.e. a date) are provided, the specification that occurs first shall apply.



Fig. 5: Different service life – engraving on the bucket/rotor



NOTE

- Refer to the table of the service life of rotors and accessories (see chapter 11.4 - " Table of the service life of rotors and accessories ")!

3.6.7.3 Service life of the Sigma "Comfort" rotor coating

Marking

II "Comfort" coated swing-out rotors have a "C" shown after their number. The bolts of these rotors do not require any greasing during the service life of the coating.

- 1 Marking indicating the "Comfort" rotor coating
- 2 Load-bearing bolt



Fig. 6: Marking of a rotor with "Comfort" coating (example)



A portfolio of the available rotors with "Comfort" rotor coating and information on the service life of the coating can be found in the document "Sigma Comfort rotor coating", which is provided with every rotor with "Comfort" rotor coating.

Service life

The service life of the coating varies and depends on the degree of utilisation of the rotor. Tests have shown a service life of 7,000 to 40,000 cycles. The service life of the "Comfort" rotor coating can be increased by way of specific measures:

The following factors have an influence on the service life:

- **Speed/load:**
The service life of the coating can be increased by a factor of 3.5 if the speed or load is decreased by approximately 15%. In case of a load decrease by 20%, the service life increases approximately by a factor of 5.5.
- **Temperature:**
The service life of the coating decreases by approximately 30% at lower temperatures (approximately 4°C) compared to room temperature (approximately 20°C).
- **Use of buckets:**
The buckets and the rotor form a joint unit. For the coating to reach the maximum possible service life, ensure to always use the same set of buckets and to install the individual buckets in their specific position within the rotor.
- **Cleaning frequency:**
Regular cleaning of the accessories is indispensable. The more frequently the rotor needs to be cleaned, the shorter the service life of the coating will be.

3 Safety



Traces of use on the black coating do not affect the anti-friction properties (see the following illustration).



Fig. 7: Load-bearing bolt with traces of use – no greasing required

End of the service life of the "Comfort" rotor coating

When the coating has worn off nearly completely and the metallic surface of the load-bearing bolt becomes visible (see the following illustration), the anti-friction effect decreases. As a result, the buckets will swing out irregularly, thereby potentially resulting in unwanted imbalance.

- From this moment on, the rotor must be used with greased load-bearing bolts (heavy-duty grease for load-bearing bolts, ref. no. 71401) until it reaches the end of its service life.
- Mark the rotor accordingly to prevent it from being used without grease on the load-bearing bolts.



Fig. 8: Load-bearing bolt with completely worn-off coating – greasing required

3.7 Safety devices

3.7.1 Lid lock device

The centrifuge can only be started when the lid is properly closed. The electrical lock must be locked. The lid can only be opened when the rotor has stopped. If the lid is opened by way of the emergency release system during operation, the centrifuge will immediately switch off and decelerate brakeless. If the lid is open, the drive is completely separated from the mains power supply, i.e. the centrifuge cannot be started (see chapter 7.1.1 - "Emergency lid release").

3.7.2 Standstill monitoring system

Opening of the centrifuge lid is only possible if the rotor is at a standstill. This standstill is checked by the microprocessor.

3.7.3 System check

An internal system check monitors the data transfer and sensor signals with regard to plausibility. Errors are detected with extreme sensitivity and displayed as error messages in a dialog box (see chapter 7.2 - "Table of error codes").

3.7.4 Earth conductor check

An earth conductor check can be carried out by authorised and specialised personnel using a suitable measuring instrument. Please contact the Sigma service department (see chapter 7.3 - "Service contact").

3.7.5 Imbalance monitoring system

A dialog box may pop up or emit a sound signal in order to indicate that the centrifuge is in the inadmissible imbalance range. If the rotor is loaded unevenly, the drive will be switched off in the acceleration phase or during the run.

3.7.6 Temperature monitoring system

If the temperature inside the rotor chamber rises above +70°C, the drive system will be switched off automatically. The centrifuge cannot be restarted until it has cooled.

3.7.7 Rotor monitoring system

When a rotor number and, if applicable, a bucket number are selected, the computer will automatically check whether the entered speed or the entered gravitational field are permissible for the selected rotor.

3 Safety

3.8 Measures in the event of hazards and accidents



DANGER

- If an emergency arises, switch off the centrifuge immediately!
- If in doubt, call the emergency doctor!

3.9 Remaining hazards

The centrifuge was built in accordance with the state of the art and in compliance with the generally recognized safety rules. However, danger to life and limb of the operator, or of third parties, or impairments of the unit or other material assets cannot be completely excluded when the unit is being used.

- Use the unit only for the purpose that it was originally intended for (see chapter 1.2 - "Intended use").
- Use the unit only if it is in a perfect running state.
- Immediately eliminate any problems that can affect safety.

4 Storage and transport

4.1 Dimensions and weight

	Sigma 6-16HS
Height:	483 mm
Height with open lid:	990 mm
Width:	581 mm
Depth:	711 mm
Weight:	116 kg

4.2 Storage conditions

The centrifuge can be stored in its original packaging for up to a year.

- Store the centrifuge only in dry rooms.
- The permissible storage temperature is between -20°C and +60°C.
- If you would like to store it for more than one year, or if you intend to ship it overseas, please contact the manufacturer.

4.3 Notes on transport

- Install the transport safety device (see chapter 4.5 - "Transport safety device")
- Always lift the centrifuge with a lifting device.
- When lifting the centrifuge, always reach under the centrifuge from the side.

**CAUTION**

The centrifuge weighs approx. 116 kg!

- For transport, use suitable packaging and, if at all possible, the original packaging (see chapter 4.4 - "Packaging").

4 Storage and transport

4.4 Packaging

The centrifuge is packaged in a wooden crate.

- After taking off the lid, remove the side panels.
- Remove the packaging material.
- Lift the centrifuge upwards with a lifting device to lift it safely. When lifting the centrifuge, always reach under the centrifuge from the side.



CAUTION

The centrifuge weighs approx. 116 kg!

- Retain the packaging for any possible future transport of the centrifuge.

4.5 Transport safety device

The transport safety device consists of two plastic screws. They are located on the base plate and can be accessed from below.



CAUTION

The transport safety device must be removed prior to start-up because the screws lock the motor bearings!

Removal

- Lift the centrifuge upwards at the front side. Always reach under from the side.
- Position a suitable object, e.g. a wooden block, between the tabletop and centrifuge. The two plastic screws are now visible on the base plate.
- Unscrew the screws by hand anti-clockwise.

4 Storage and transport

1 Locking screws

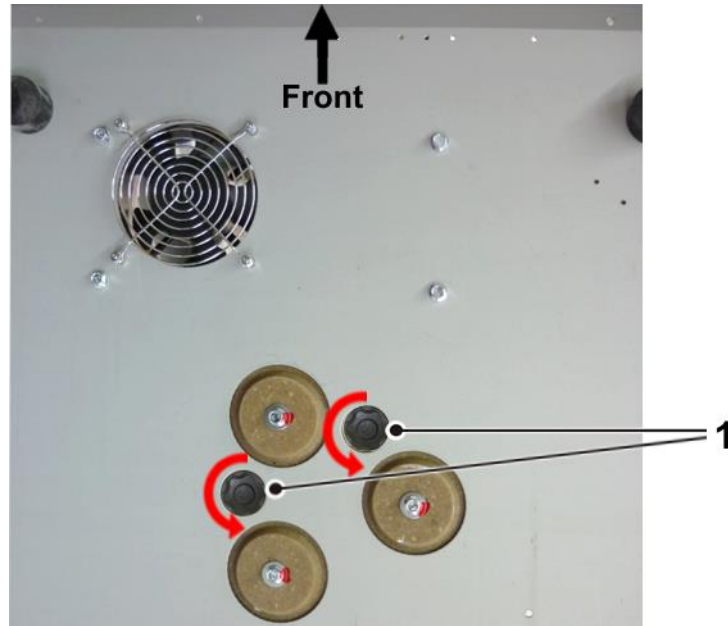

Fig. 9: Unscrew the locking screws by turning them anti-clockwise

- Retain the transport safety device for the possibility of the return of the centrifuge.

5 Set-up and connection

5 Set-up and connection

5.1 Installation site

Operate the centrifuge only in closed and dry rooms.

All the energy supplied to the centrifuge is converted into heat and emitted to the ambient air.

- Ensure sufficient ventilation.
- Keep a safety range of at least 30 cm free around the centrifuge as well as with regard to walls or other devices so that the vents in the machine remain unobstructed and fully effective.
- Do not subject the centrifuge to thermal stress, e.g. by positioning it near heat generators.
- Avoid direct sunlight (UV radiation).
- The table must be stable and have a solid, even surface.
- Attention: During transport from cold to warmer places, condensational water will collect inside the centrifuge. It is important to allow sufficient time for drying (min. 24 h) before the centrifuge can be used again.

5.2 Power supply

5.2.1 Type of connection



DANGER

The operating voltage on the name plate must correspond to the local supply voltage!



CAUTION

The mains power plug is an isolating device which is why it must be accessible at all times.

Sigma centrifuges are units of protection class I. The centrifuges of this model series have a three-wire power cord with a fixed cable. They are equipped with a mains power switch with an integrated thermal circuit breaker.

- Switch the unit off by actuating the mains power switch.
- If it has tripped, let the circuit breaker cool for approximately 2 minutes.
- Switch the unit on.

The centrifuge is now ready for operation.

5.2.2 Customer-provided fuses

Typically, the centrifuge must be protected with 16 Amp B fuses that are to be provided by the customer.



To ensure safe disconnection in the event of a fault, an AC/DC-sensitive RCD (residual current device) must be integrated in the wiring system of the building.

6 Using the centrifuge

6 Using the centrifuge

6.1 Initial start-up



DANGER

- Before the initial start-up, please ensure that your centrifuge is properly set up and installed (see chapter 5 - "Set-up and connection").

6.2 Switching the centrifuge on

- Press the mains power switch.

The display then illuminates. The centrifuge is ready for operation.



NOTE

As a default setting of the 6-16HS, the petroleum program "ASTM oil" is stored in the system (see chapter 6.3.2.5 - "Standard menu").

6.2.1 Opening and closing the lid

The lid can be opened if the centrifuge is at a standstill and if the lid key is illuminated.

- Press the lid key in order to open the lid.

The centrifuge cannot be started if the lid is opened.

- To close, press with both hands slightly on the lid until the lock is audibly locked.



WARNING

Do not place your fingers between the lid and the housing when closing the lid. Risk of crushing!

6.2.2 Installation of rotors and accessories

6.2.2.1 Installation of a rotor

- Open the centrifuge lid by pressing the lid key.
- Unscrew the rotor tie-down screw from the motor shaft (counter-clockwise).
- Lower the rotor with its central bore straight down onto the motor shaft.
- Tighten the rotor tie-down screw clockwise with the supplied rotor wrench with 10 Nm (Option: torque wrench 10 Nm, part no. 17060). In doing so, hold the rotor at its outer rim.
- Follow the safety instructions and hazard warnings (see chapter 3 - "Safety")!

**WARNING**

Once a day or after 20 cycles, the rotor tie-down screw must be loosened by some turns, and the rotor must be lifted and fastened again. This ensures a proper connection between the rotor and the motor shaft.

**CAUTION**

When using rotors for microtiter plate formats:

Ensure that the plate holders are inserted together with the plates into the buckets.

**NOTE**

The lid screw serves for the fastening of the lid onto the rotor only, not for the fastening of the rotor onto the motor shaft.

Removing a rotor

- Loosen the rotor tie-down screw by turning it anti-clockwise and remove the rotor.

6 Using the centrifuge

6.2.2.2 Installation of an angle rotor with a hermetic lid

- Open the centrifuge lid by pressing the lid key.
- Unscrew the rotor tie-down screw from the motor shaft (counter-clockwise).
- Screw the hermetic lid onto the rotor and tighten it clockwise by hand.
- Lower the rotor with the lid with its central bore straight down onto the motor shaft.
- Insert the rotor tie-down screw into the motor shaft. Tighten the rotor tie-down screw clockwise with the supplied rotor wrench with 10 Nm (Option: torque wrench 10 Nm, part no. 17060). In doing so, hold the rotor at its outer rim.
- Follow the safety instructions and hazard warnings (see chapter 3 - "Safety")!



The rotor can also be used without a lid.



The lid screw serves for the fastening of the lid onto the rotor only, not for the fastening of the rotor onto the motor shaft.

Removing a rotor

- Loosen the rotor tie-down screw anti-clockwise and remove the rotor together with the lid.
- Loosen the lid by turning it anti-clockwise and then remove it.

- 1 Rotor tie down screw
- 2 Lid
- 3 Rotor

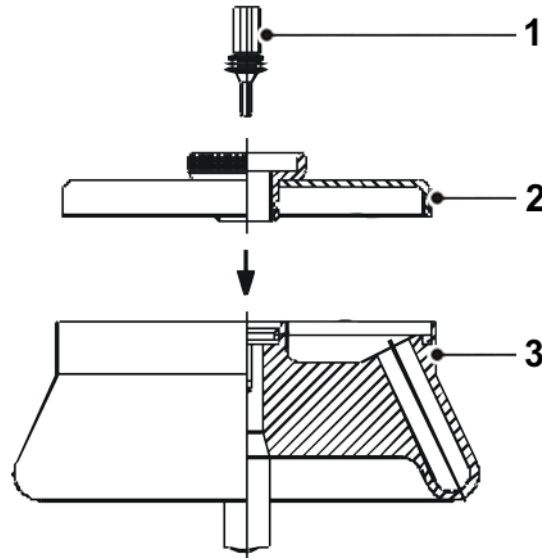

Fig. 10: Angle rotor with a hermetic lid

6 Using the centrifuge

6.2.2.3 Installation of accessories

- Only use vessels that are suitable for the rotor.
- In the case of swing-out rotors, all of the compartments must be equipped with buckets.
- Always load rotationally symmetrical compartments of the rotors with the same accessories and fill to avoid imbalance.

Centrifugation with vessels of various sizes

Working with vessel of various sizes is possible. In this case, however, it is very important that the rotationally symmetrical inserts are identical (see figure).

correct

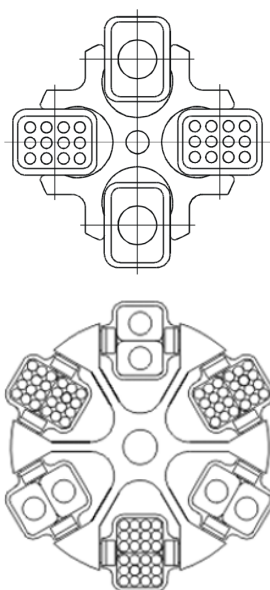

incorrect

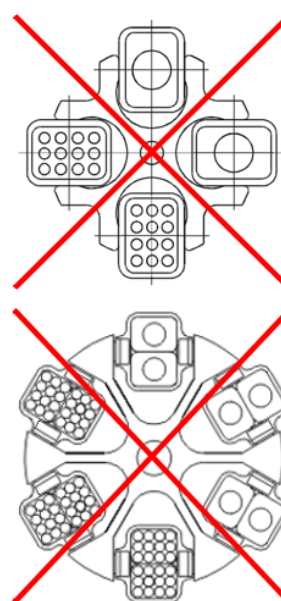

Fig. 11: Permissible and impermissible loading of a swing-out rotor with vessels of various sizes (example illustration)

6 Using the centrifuge

Centrifugation with low capacity

- Install the sample vessels in a rotationally symmetrical manner so that the buckets and their suspensions are loaded evenly.
- It is not permissible to load angle rotors on only one axis.

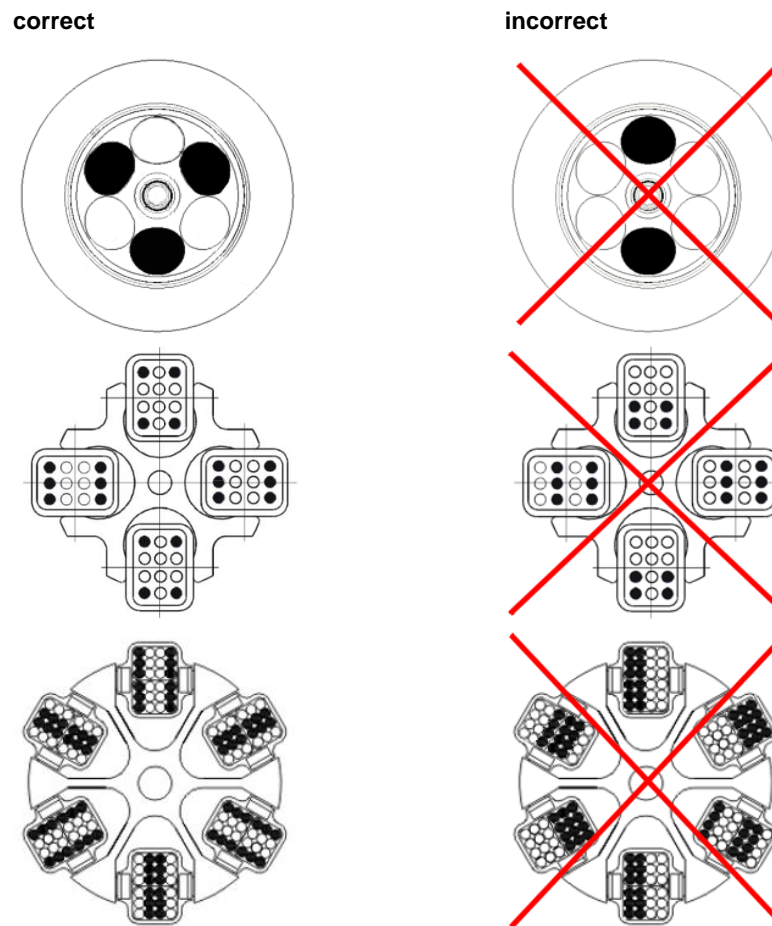

Fig. 12: Permissible and impermissible loading of an angle rotor and a swing-out rotor (example illustrations)



Pay attention to the marking of the centrifuge (see the illustration below)! Safety indications on the centrifuge must be kept readable at all times. If necessary, they must be replaced.

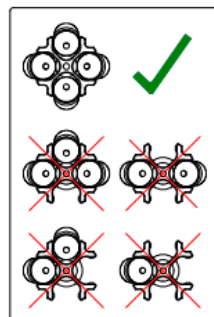

Fig. 13: Safety indication on the centrifuge: Loading of a swing-out rotor

6 Using the centrifuge

Double rectangular bucket 13420 and bucket 13621

The double rectangular bucket 13420 and the bucket for microtiter plates 13621 are dynamically balanced at the factory. Therefore, the buckets must be installed in sets of 4 and in the prescribed order (see the numbers on the buckets and on the rotor).



CAUTION

Mixed use with only two buckets on opposite sides will cause increased imbalance!

6.2.2.4 Adapters

In order to ensure easy handling, even if vessels of various sizes are used, carrier systems were developed.

- Load the opposite adapters with the same number of vessels and with the same weights in order to avoid imbalance.
- If all of the compartments of a carrier are not used, the buckets must be loaded evenly. Loading the edges of a bucket only is not permissible.

6.2.2.5 Vessels

- Load the vessels outside of the centrifuge. Liquids in the buckets or multiple carriers cause corrosion.
- Fill the vessels carefully and arrange them according to their weight. Imbalances result in the excessive wear of the bearings.
- Always fill the tubes up to their useful volume (= the volume that is stated for the tube).
- After the centrifugation, remove the vessels carefully in order to prevent the samples from mixing.
- Follow the safety instructions and hazard warnings (see chapter 3 - "Safety")!

Maximum speed for tubes

Some tubes, such as centrifuge glass tubes, microtubes, culture tubes, fluoropolymer tubes and especially high-volume tubes can be used in our rotors, buckets, and adapters at higher speeds than their breaking limit.



NOTE

When using glass vessels, the maximum value of 4,000 x g must not be exceeded (except special high-strength glass tubes; please refer to the information provided by the manufacturer).



NOTE

When installing the 500 ml bottles use the supplied supporting rings

6.2.2.6 Blood bag systems

The centrifuge tolerates an imbalance of approx. 20 g. Therefore, it is important to balance the buckets carefully.

- All four places of a rotor must be loaded with buckets. It is permissible to fill just two opposite buckets with blood bag systems.
- The opposite buckets including the filled blood bag systems must have an equal weight.
- The blood bags have to be put into the opposite buckets mirror-inverted.
- If in one bucket the main blood bag is on the left side, then the main blood bag inserted in the opposite bucket has to be on the right side.

- 1 Filter
2 Blood bag

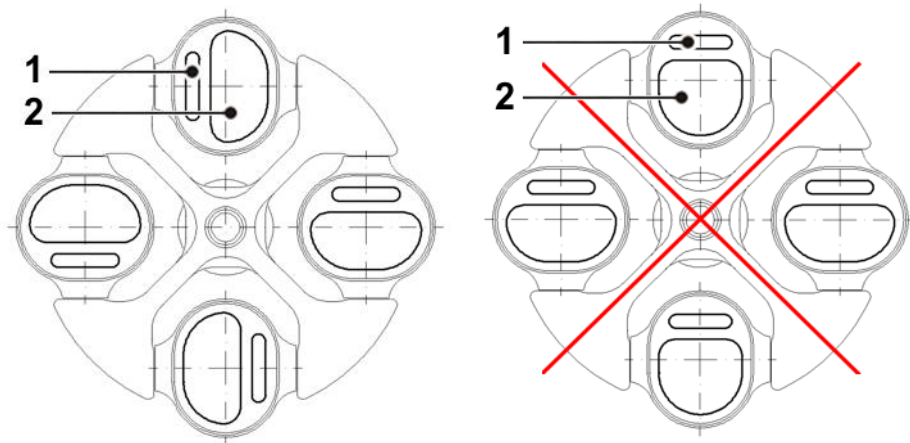

Fig. 14: Loading of blood bag systems

- When using smaller bag systems or in case of incompletely filled blood bags adapters (e.g. part no. 17750) have to be inserted together with the blood bag systems. This will avoid slipping of the bags which could result in an imbalance.
- For the centrifugation of human blood suitable acceleration and deceleration curves must be used. Curve no. 12 is the most suitable for this purpose.

6 Using the centrifuge

A German blood bank works successfully using the following data:

Temperature ¹⁾	Speed	RCF	Timet	Acceleration curve ²⁾	Deceleration curve	Program
°C	rpm	x g	min	no.	no.	
22	3,750	4,544	7	20 (2 min)	12	1 Full blood
22	3,570	4,544	10	20 (2 min)	12	2 Full blood in 4fold bags
20	4,000	5,170	12	24 (3 min)	12	3 Plasma with buffy coat
22	3,750	4,544	9	20 (2 min)	12	4 Full blood
20	4,000	5,170	14	24 (3 min)	12	5 Plasma with buffy coat
22	1,094	384	7	21 (2 min)	11 or 2 min	6 Platelets with buffy coat
22	1,094	384	7	21 (2 min)	11 or 3.5min	7 Platelets with buffy coat

¹⁾ only with special equipment heater

²⁾ Curves no. 20, 21 and 24 are freely programmable curves



NOTE

If the centrifuge does not reach the mentioned RCF values, the maximum gravitational field must be set and the run time must be extended.

6.2.2.7 Centrifugation with tubes for mineral oil

In the ASTM standard, a maximum gravitational field of 800 x g is required for the centrifugation with tubes for mineral oil. Practically, it is possible to reach higher RCF-values with the rotor 11165 and the buckets 13113, 13114 or 13116.



CAUTION

The required gravitational field must not be exceeded. Values above 800 x g increase the risk of glass breakage!

This is why a program is stored in the system as a default setting of the centrifuge. This program is specifically adapted to the petroleum rotor 11165 with buckets of the 13113 type.

- Use sealing caps (part no. 17107).

6.3 Control system "Spincontrol S"

6.3.1 User interface

The centrifuge is operated via three buttons with integrated light-emitting diodes and one function knob. The display is divided into several different fields. The various functions of the system can be called up by pressing and turning the function knob.

- 1 Start button
- 2 Display
- 3 Function knob
- 4 Stop button
- 5 Lid button



Fig. 15: User interface of the Spincontrol S control system

Display

The centrifuge display has the following fields:

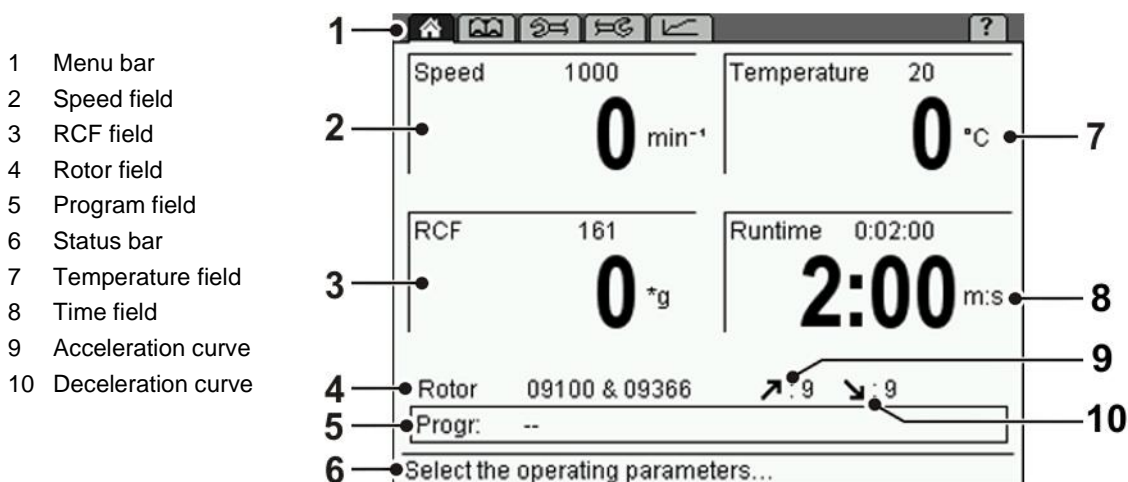

Fig. 16: Display of the Spincontrol S control system

6 Using the centrifuge

6.3.2 Manual mode

6.3.2.1 Starting a centrifugation run

The centrifuge is ready for operation when the start key is illuminated.

- Press the start key in order to start a centrifugation run.

6.3.2.2 Interrupting a centrifugation run

- Press the stop key in order to interrupt a centrifugation run. The centrifugation run will be terminated prematurely.

Quick stop

- Press the stop key for more than three seconds.

The centrifuge decelerates with the maximum deceleration curve.

After a quick stop, the centrifuge lid must be opened before a new centrifugation run can be started.

A quick stop can also be triggered during a normal deceleration, e.g. in order to speed up the deceleration.

When a quick stop is triggered, "Quick stop" will be displayed in the speed field.



A quick stop can be performed even if the centrifuge is blocked against unauthorised use.

6.3.2.3 Interrupting a deceleration process

- Press the start key during a deceleration process in order to interrupt it and to restart the centrifuge.

6.3.2.4 Selection, display, and modification of data

The "Standard" menu is displayed.

- Turn the function knob in order to select a field. The selected field is inverted.
- Press the function knob. The display starts to flash and the modification mode is active.
- Turn the function knob in order to modify the set value of the selected field.
- Press the function knob again to confirm the entry and to quit the modification mode.

6.3.2.5 Standard menu

The "Standard" menu is symbolised by the icon "⚙️" on the menu bar and it is displayed a few seconds after the centrifuge has been switched on. In this menu, the parameters of a centrifugation run can be displayed and modified.



As a default setting of the 6-16HS, the petroleum program "ASTM oil" is stored in the system (see the program list in this chapter).

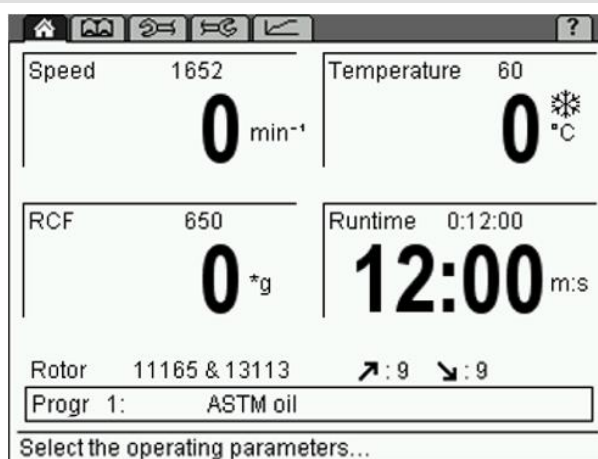

Fig. 17: Standard menu

Speed

In the upper section of the field, the set speed of the centrifuge is displayed. The actual speed is displayed below this value. The values are stated in revolutions per minute ($\text{min}^{-1} = \text{rpm}$) and depend on the RCF values (see chapter 2.2.2.1 - "Speed, radius, and relative centrifugal force"). The maximum speed values depend on the rotor that is used.

Relative centrifugal force (RCF)

The relative centrifugal force is the acceleration that the sample is subjected to during the centrifugation run. The set value of this parameter is displayed in the upper section of this field, with the actual value shown below. The values are stated in g (gravitational acceleration) and they depend on the speed values (see chapter 2.2.2.1 - "Speed, radius, and relative centrifugal force"). The maximum RCF values depend on the rotor that is used.



Temperature

The set temperature is displayed in the upper section of the field, with the current sample temperature shown below. Temperatures between -20°C and $+70^{\circ}\text{C}$ can be preselected. The maximum rotor temperature depends on the rotor that is used.

6 Using the centrifuge

Runtime

The set runtime is displayed in the upper section of this field, with the remaining runtime shown below. The runtime is defined as the period from the start of the centrifuge to the beginning of the deceleration phase. The maximum value is 99 h 59 min 59 sec.

In the "Setup" menu , it can be specified that the runtime is not to be started until the set speed is reached (see chapter 6.3.2.8 - "Setup menu"). In this case, the symbol "!" appears in the runtime field.

Continuous run

During the continuous run, the runtime of the centrifuge is unlimited and must be stopped manually. The centrifuge accelerates during the continuous run until the set speed is reached.

- Select the field "Runtime" and confirm the selection. The display flashes when it is activated.
- Turn the function knob from the time 0:00:10 anti-clockwise or from the time 99:59:59 clockwise. "Infinite" will be displayed. After the start of the centrifuge, the elapsed time will be displayed.
- Deactivate the continuous run by pressing the stop button or by entering a specific run time.

Short run

A short run can be started if no run is active.

- Keep the start button pressed during the short run.

During the short run, the centrifuge accelerates with the maximum acceleration curve until the maximum speed of the rotor is reached. The runtime is counted and in the speed field the message "Short run" flashes.

When the start button is released, the centrifuge decelerates at maximum brake to a standstill.



The parameters speed, RCF, temperature, and runtime can be changed during the centrifugation.



If the centrifuge is locked with level 02 or higher, it is not possible to start a short run.

Rotor: rotor selection list

This field shows the rotor that is currently being used.

- Select the field "Rotor" and confirm the selection. A list with all of the possible rotors without buckets is displayed.
- Select the desired rotor.
 - If an angle rotor is selected, additional information concerning this rotor will be displayed.
 - In the case of swing-out rotors, a list with all of the possible rotor/bucket combinations will be displayed. Select an item from the list so that the additional information concerning the combination will be displayed.
- Press the function knob in order to accept the data.

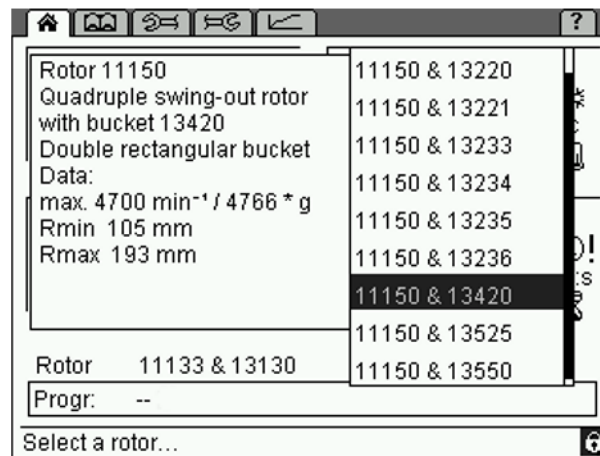

Fig. 18: Rotor selection list; here for a swing-out rotor

Automatic rotor identification

The centrifuge automatically identifies the rotor that is being currently used.

- If the system identifies a different rotor than the one that is set and if there are no different buckets for this rotor, the rotor input will be adapted automatically. The system will not display a message.
- If the system identifies a different rotor than the one that is set, and if there are different rotor/bucket combinations for this rotor, the system will automatically identify the correct rotor and select the rotor/bucket combination with the lowest speed. The system will display a corresponding message so that the combination can be adapted manually.
- If the system cannot identify the rotor, a message will be displayed. The rotor cannot be used in the centrifuge.

This prevents the maximum permissible speed from being exceeded.

6 Using the centrifuge

Acceleration ↗

This function is used to select an acceleration curve. One can select a linear rise (curves 0-9) or a quadratic rise (curves 10-19). The acceleration curves 20-29 can be programmed as desired (see chapter 11.3 - "Acceleration and deceleration curves").

Deceleration (Brake) ↘

This function is used to select a curve that decelerates the centrifuge to a standstill. Deceleration curves are inverted images of the acceleration curves and are labelled with identical numbers. Deceleration curve no. 0 represents a brakeless deceleration.

Progr.: program list

This field in the "Standard" menu shows the program that is currently loaded. When the field is selected, the program list is displayed (for information on how to work with the programs, please see chapter 6.3.3 - "Program mode").

The program "RAPID_TEMP" (see below) cannot be deleted.





Abb. 19: Program list

Programm "ASTM oil"

This program is stored in the system as a default setting of the centrifuge. It is specifically adapted to the petroleum rotor 11165 with buckets of the 13113 type.

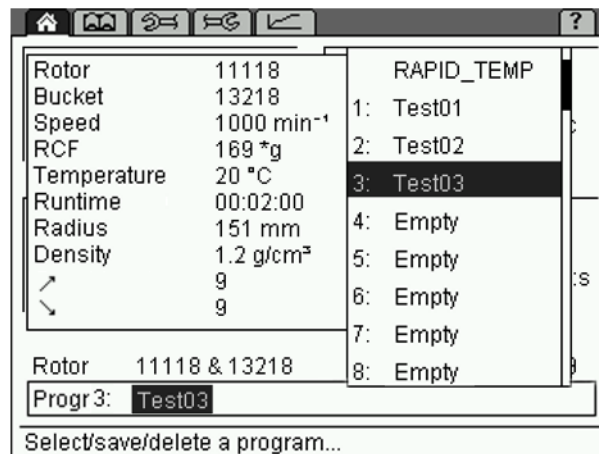
- Select the option "Progr" in the "Standard" menu  and confirm the selection. The program list will be displayed.
- Select the program "ASTM oil" from the list and confirm the input. The following values will be loaded:

Language:	English
Rotor/bucket:	11165/13113
RCF:	650
Temperature:	+60°C
Runtime:	12:00 min
Acceleration:	6
Deceleration:	6

In addition, the standstill heating will be activated and the automatic lid opening function will be disabled.

Program "RAPID_TEMP"

Preheating at a standstill may distort the measurement results and subsequently cause increased wear of the mechanical components. This is why the centrifuge has a special program that preheats the centrifuge rapidly under defined conditions:

- Select the option "Progr" in the "Standard" menu  and confirm the selection. The program list will be displayed.
- Select the program "RAPID_TEMP" on the program list and confirm the selection. The display shows $\frac{1}{3}$ of the maximum rotor speed and the corresponding RCF value. The deceleration (brake) and acceleration curves correspond to curve 9 and the runtime field indicates "infinite" (continuous run).

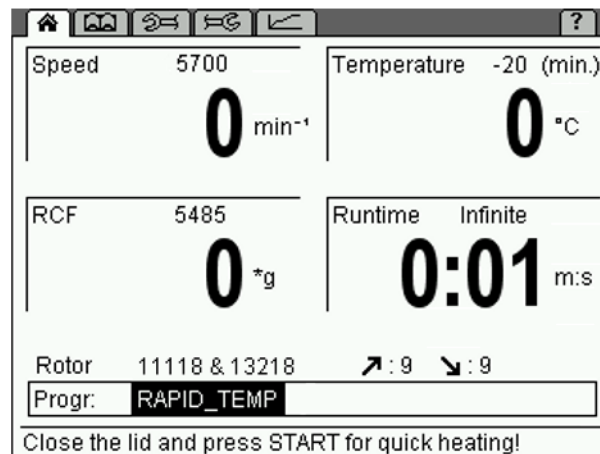

Fig. 20: Program "RAPID_TEMP"

i NOTE

The program will only be loaded if the actual temperature is below the set temperature.

- Press the start button in order to start the temperature control run.
- During the temperature control run, only the set temperature can be changed.

The current status of the program will be displayed on the status bar.

The "RAPID_TEMP" program will be stopped under the following conditions:

- The set value is reached. In this case, the "RAPID_TEMP" program stops with a sound signal (if this feature is activated), and the standstill heating system will be activated.
- The stop button is pressed. The "RAPID_TEMP" program will be stopped prematurely. No message will be issued when the set temperature is reached.
- A parameter is changed (except for the temperature) or another input is made. In this case, the "RAPID_TEMP" program will be aborted. No message will be issued when the set temperature is reached.

After the stop, the previous program will be reloaded or the changed parameters will be adopted as the new settings.

6 Using the centrifuge



The automatic lid opening function is suppressed after a temperature control run in order to prevent the material from cooling again.



The delta T temperature monitoring system (see chapter 6.3.2.7 - "Parameters menu", Process) remains inactive as long as the "RAPID_TEMP" program is active.



If the "RAPID_TEMP" program is used, the temperature of the unloaded aluminium bucket will be displayed. If samples, which have not been preheated, are placed into the buckets, the displayed temperature will deviate from the actual sample temperature.

Progress indicator

The progress indicator provides a quick overview of the remaining runtime of the running centrifugation run. For this purpose, a green progress bar and percentage value are displayed in the program field.

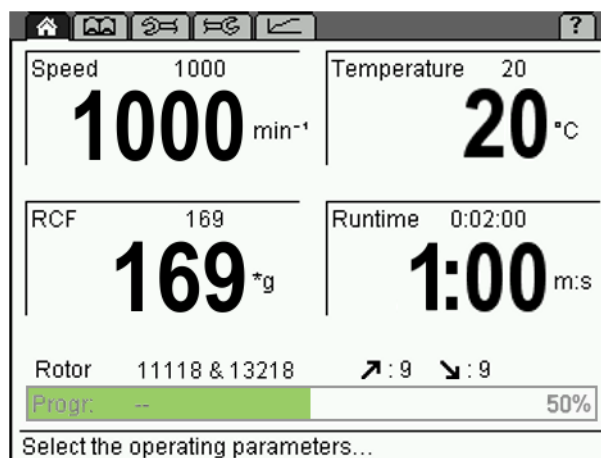

Fig. 21: Progress indicator during a centrifugation run

After the completion of the centrifugation run, the progress indicator remains at 100% until

- the lid is opened,
- a parameter is changed,
- a program is loaded, saved, or deleted, or
- a new centrifugation run is started.

6.3.2.6 Process library menu

The process library can be opened via the "📖" symbol on the menu bar. It provides the user with an overview of all of the stored programs as processes.

The processes are listed with their name, RCF, runtime, and temperature (exception: the "RAPID_TEMP" program will not be listed).

The order of the processes corresponds to their storage locations on the program list. Empty storage locations will not be displayed. If more than 11 programs have been stored, the user can scroll through the list.

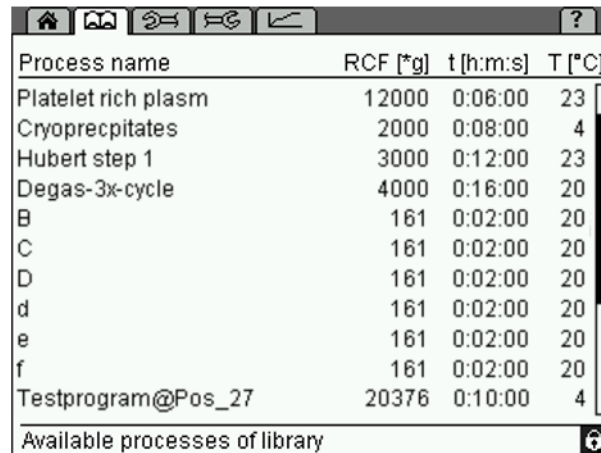

Process name	RCF [*g]	t [h:m:s]	T [°C]
Platelet rich plasm	12000	0:06:00	23
Cryoprecipitates	2000	0:08:00	4
Hubert step 1	3000	0:12:00	23
Degas-3x-cycle	4000	0:16:00	20
B	161	0:02:00	20
C	161	0:02:00	20
D	161	0:02:00	20
d	161	0:02:00	20
e	161	0:02:00	20
f	161	0:02:00	20
Testprogram@Pos_27	20376	0:10:00	4

Available processes of library

Fig. 22: Process library menu

Loading a process

- In the process library, select the desired process by turning the function knob. Press the function knob in order to confirm the selection.

The process will be loaded and the "Standard" menu 🏠 will be displayed.

Starting a process

- In the process library, select the desired process by turning the function knob. Then, press the start button.

The process will be loaded and started. The "Standard" menu 🏠 will be displayed.

6 Using the centrifuge

6.3.2.7 Parameters menu

The "Parameters" menu is symbolised by the "⚙️" symbol on the menu bar. It is used to specify various conditions for the centrifugation. These conditions are used to monitor the process and to control access to the centrifuge.

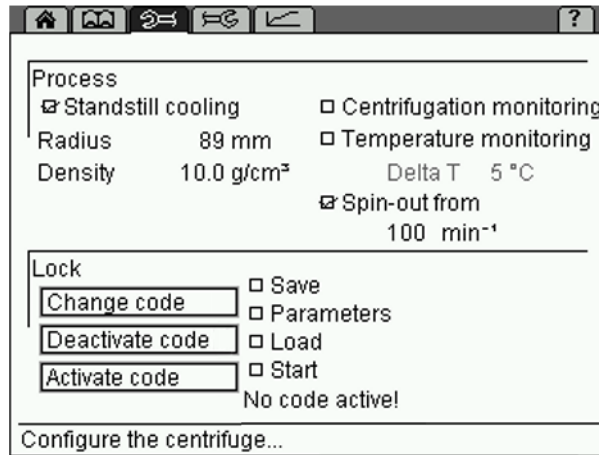

Fig. 23: Menu "Parameters"

Process

Standstill heating

Depending on the substances to be centrifuged, it may make sense to preheat the centrifuge. The preheating prevents the heated samples in the unheated centrifuge from cooling down to an inadmissible temperature level.

If the standstill heating is activated, the centrifuge starts to preheat after it is switched on. In the runtime field, the symbol "❄️" is displayed. The lid must be closed.



The centrifuge is equipped with the "RAPID_TEMP" program. This program is used to preheat the rotor chamber quickly under defined conditions (see chapter 6.3.2.5 - "Standard menu", Program list).

Radius

The radius determines the values of the relative centrifugal force (RCF) that the sample is subjected to. Normally, the maximum RCF value is displayed. If the value is reduced manually, a downward facing arrow "↓" will be displayed in the RCF field.

Density

This setting is useful for glass vessels. If the density of the liquid to be centrifuged is higher than 1.2 g/cm³, the value must be adapted manually in order to prevent the glass vessel from breaking. This will reduce the maximum possible final speed (see chapter 2.2.2.2 - "Density"). The reduction will be represented by a downward facing arrow "↓" in the speed field. Values between 1.2 and 10.0 g/cm³ are possible.

Centrifugation monitoring

The centrifugation monitoring function enables the continuous monitoring of the speed and runtime parameters during the centrifugation.

- Activate the centrifugation monitoring function by clicking.



If the function is activated during a centrifugation run, the monitoring process will not be started until the start of the next centrifugation run.

The centrifugation monitoring function compares the speed values of the current run with the reference values that are stored in the control unit. After every run, it issues a corresponding message.

The runtime is considered faulty if the centrifugation run had to be stopped prematurely.

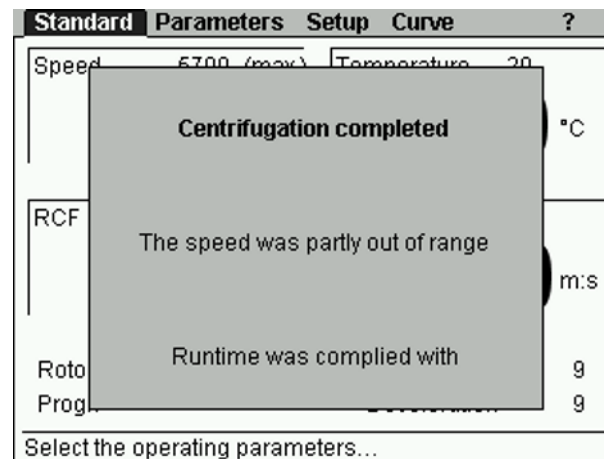

Fig. 24: Example of a centrifugation monitoring message



If the centrifugation monitoring system is used in combination with free acceleration or deceleration curves, unjustified error messages may result in certain cases.

Temperature monitoring

The control system includes a temperature monitoring function. If the actual temperature difference with regard to the set value deviates from the set temperature difference, the centrifuge will stop and an error message will be issued.

- Activate the temperature monitoring function by clicking.
- Adjust the desired "Delta T" limit value in steps of 1°C or 1°F and confirm the setting.

If the temperature monitoring function is active, the symbol "±" is displayed in the temperature field of the "Standard" menu.

In this case, the centrifuge can only be started if the current temperature is between the preset temperature in the "Standard" menu and the "Delta T" limit value.

6 Using the centrifuge

If the temperature leaves this range during the centrifugation run, an error message will be displayed and the centrifuge will be decelerated to a complete standstill.



The delta T temperature monitoring system remains inactive as long as the "RAPID_TEMP" program is active (see chapter 6.3.2.5 - "Standard menu", "Program "RAPID_TEMP"").

Spin-out from...

If this function is active, the brake will be deactivated when the actual speed is below the set speed. As a result, the rotor will spin out in a brakeless manner.



A spin-out, in particular with heavy rotors and at high speeds, can take a lot of time! (Depending on the rotor and load, the speed will be reduced by approximately 0.5 to 1 rpm per second.)

If the spin-out is active, "+0" is displayed next to the deceleration curve.

- The spin-out can be interrupted by a quick stop or by restarting the centrifuge.

Lock

In order to prevent any unauthorised use of the centrifuge, the following functions can be blocked:

- Saving of programs (level 01)
- Changing of parameters, short run (level 02)
- Loading of programs (level 03)
- Start button (level 04)

Blocking a function

- Select the function that is to be blocked. The lower levels will also be automatically selected (if, for example, the "Parameters" function is selected, the "Save" function will also be selected).
- Select the button "Activate code".
- Enter a four-digit code and confirm the entry.

The lock is now active. The symbol "🔒" will be displayed in the status line and the lock level will be indicated.

If changes are made after a function has been blocked, the system will ask for the code prior to executing the change.

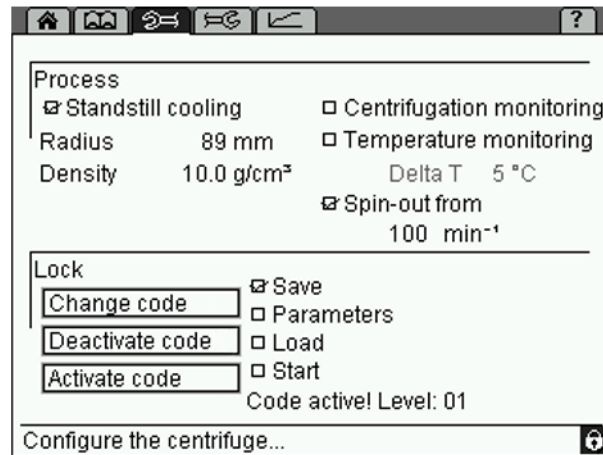

Fig. 25: "Parameters" menu with an active lock (level 01)

Unblocking a function

- Select the button "Deactivate code".
- Enter the code and confirm the entry.

The lock is now deactivated.

Changing the code

- Select the button "Change code".
- Enter the old code and confirm the entry.
- Enter the new code.
- For safety reasons, the code must be entered a second time.

The code is now changed.

6 Using the centrifuge

6.3.2.8 Setup menu

The "Setup" menu is symbolised by the "⚙️" symbol on the menu bar. It is used to perform basic settings concerning the control system of the centrifuge. It enables the optimum adaptation of the centrifuge to its specific area of application.

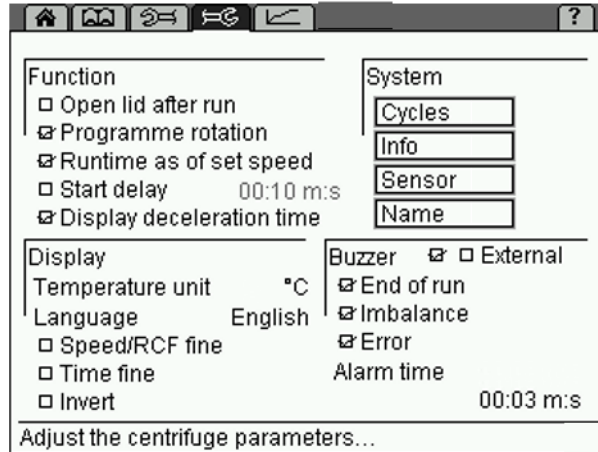

Fig. 26: Menu "Setup"

Function

Open lid after run

The automatic lid opening function ensures that the lid opens when the rotor has stopped.



CAUTION

When the lid is open, the cooling is not active. The sample may warm up!

Program rotation

See chapter 6.3.3.5 - "Automatic program rotation".

Runtime as of set speed

If this function is active, the runtime will not be measured until the set speed is reached. In the "Standard" menu, the symbol "⌚!" will be displayed in the runtime field.



NOTE

In the program mode, this function can be saved separately for every program. In this case, the symbol "⌚!" will be displayed under the runtime of the detailed program description.

Start delay

If the start delay function is active, the centrifuge will not start until the preset time has elapsed. The symbol "⌚" will be displayed in the runtime field.

Display deceleration time

In the activated mode, the deceleration time will be displayed instead of the runtime during and after the deceleration process. Below the time display, the symbol "⏻" will be displayed. During a deceleration process, the symbol flashes. Once the deceleration is complete, it is displayed in a permanent manner.

Display

Temperature unit

The temperature can be displayed in °C (Celsius) or °F (Fahrenheit).

Language

The control system can be used in various language versions.

If a language is selected by mistake, it can be changed on any screen as follows:

- Press and hold the stop button.
- Turn the function knob one notch to the left and then one notch to the right.
- Release the stop button. The "Language" window will be displayed.
- Select the desired language.

Speed/RCF fine and Time fine

This menu item can be used to preselect the set speed in steps of 1 rpm (instead of 100 rpm), the RCF value in steps of 1 x g (instead of 10 x g), and the set time in steps of 1 min or 1 sec (instead of 10 min or 10 sec).



Regardless of the fine adjustment, the step size increases when the function knob is turned quickly.

Invert

If this function is activated, the display switches from the standard setting with a bright background and dark writing to a dark background with bright writing.

6 Using the centrifuge

System

Cycles

This field shows the number of cycles as well as the runtime of the rotor and buckets that are used.

Info

This item provides information on the software versions that are used in this centrifuge.

Sensor

The sensor mode is reserved for the service personnel.



Values can neither be entered nor changed in the menus "Cycles", "Info", and "Sensor".

Name

In this field, an identification will be assigned to the centrifuge.

- The letters and characters can be entered when the cursor flashes in the text field. Turn the function knob in order to select a character and press it to confirm the selection. Then, press the knob again in order to enter the next character. Pressing the arrow button ← will delete the last character. The maximum number of characters is 19.
- When the name is complete, select the option "Accept" and confirm it.

Buzzer (signal)

With this function, a warning sound signal can be selected for

- the end of a centrifugation run,
- an imbalance message,
- an error message.

The duration of the warning signal can be specified.

External

This function is only available if the centrifuge is equipped with the option for the input and output of data (external signal, floating switch) (see chapter 6.3.4 - "Options for data input and output").

6.3.2.9 Curve menu

This menu is used to create and edit customised acceleration and deceleration curves (see chapter 11.3 - "Acceleration and deceleration curves"). It is symbolised by the "⏮" symbol on the menu bar.

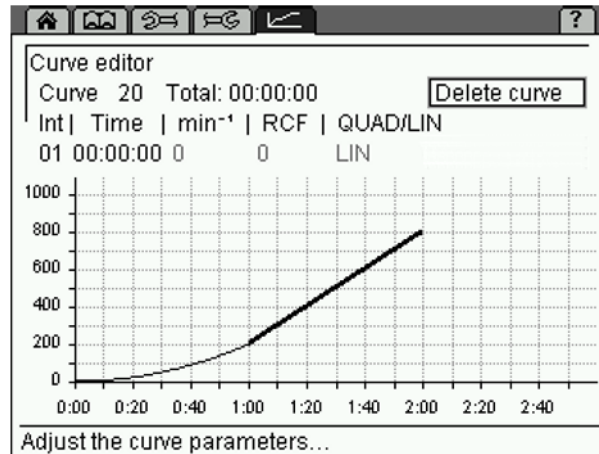

Fig. 27: Menu "Curve"

Creating or changing an acceleration curve

During a centrifugation run, curves can only be displayed. They cannot be changed or deleted.

- Select the "Curve" menu. The curve editor will be displayed.
- Select a curve number between 20 and 29 in the input field "Curve". If the curve number is already used, the stored curve will be displayed.
- The input field "Int" is used to specify the interval number of the process. Up to ten intervals can be entered for a curve.
- Enter the interval time of the current interval into the input field "Time". While doing so, certain restrictions must be taken into consideration (see below).
- Enter the desired acceleration under "min⁻¹" (rpm) or "RCF". While doing so, certain restrictions must be taken into consideration (see below). The values are interdependent.
- In the first interval, "QUAD/LIN" can be used to select a linear or quadratic rise. All of the other intervals are linear.

The field "Total" shows the total runtime of the process. The maximum total runtime of a curve depends on the slope of the curve and on the final speed of the rotor.



Only the last curve interval can be changed retroactively.

6 Using the centrifuge

Restrictions

- Acceleration and deceleration curves can include intervals with a positive slope as well as intervals with a negative slope and also intervals with 0 slope.
- The slope of the curve intervals can be $1 \text{ min}^{-1}/\text{sec}$ (rpm/sec) minimum and $1000 \text{ min}^{-1}/\text{sec}$ (rpm/sec) maximum.
- Quadratic curve intervals are only possible between 0 and 1000 min^{-1} (rpm) maximum. If a final speed $> 1000 \text{ min}^{-1}$ (rpm) is selected, this interval will automatically become linear above 1000 min^{-1} (rpm).
- The possible runtime results from the maximum possible speed (depending on the rotor) and from the slope limitation.

Example 1: Start speed 0 min^{-1} (rpm), final speed 100 min^{-1} (rpm), runtime 1 hour not possible, since the necessary slope $< 0.03 \text{ min}^{-1}$ (rpm), which means that it is beyond the defined range.

Example 2: Start speed 0 min^{-1} (rpm), final speed 15000 min^{-1} (rpm), runtime 10 sec. not possible, since the necessary slope is 1500 min^{-1} (rpm), which means that it is beyond the defined range.

6.3.2.10 Help menu

The help function is symbolised by the "?" symbol on the menu bar. It provides a short description of the control elements of the selected option.

Activating and deactivating the help function

- Select the question mark on the menu bar and press the function knob.
- Quit the help function by selecting the question mark and by pressing the function knob again.

Parameters can still be changed when the help function is activated.

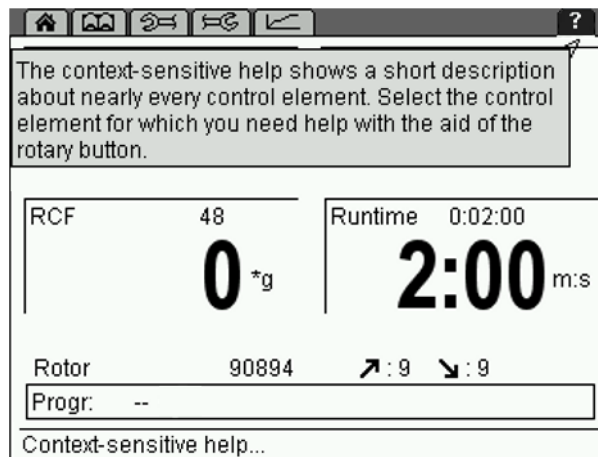

Fig. 28: Menu "Help"

6.3.2.11 Changing the contrast

To change the contrast:

- Press and hold the stop button and turn the function knob one notch to the left. A dialog box will be displayed once the stop button is released.
- Adjust the contrast of the centrifuge display and confirm the change.

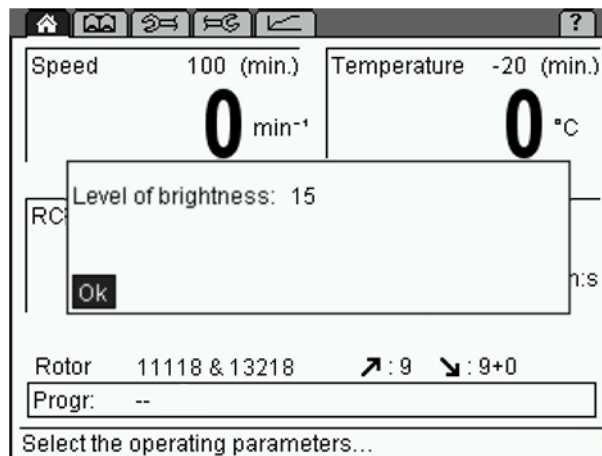

Fig. 29: Dialog box for changing the contrast

6.3.3 Program mode

A program contains all of the data that are required for a centrifuge run. Certain sedimentation results can be repeated under identical conditions. Programs can be loaded, executed, edited, and deleted when the centrifuge is at a standstill.

A maximum of 60 programs can be stored under the numbers 1-60. The program "RAPID_TEMP" does not occupy any storage location and cannot be deleted. It is used to bring the centrifuge to a specific temperature without any vessels.

"--" means that the values that are currently set are not a stored program.

The programs can be protected against unauthorised use, modification, or deletion with the aid of a code (see chapter 6.3.2.7 - "Parameters menu").

Stored programs are listed in the "Process library" menu .

6 Using the centrifuge

6.3.3.1 Saving a program

- Enter the parameters that are to be included in the program.
- Select the option "Progr" in the "Standard" menu  and confirm the selection. The program list will be displayed.
- Select a storage location from the program list.
- Save the program under the desired name. The letters and characters can be entered when the cursor flashes in the text field.
 - Turn the function knob in order to select a letter and press it to confirm the selection. Then, the next character can be selected.
 - Pressing the arrow button ← will delete the last character.
- When the program name is complete, select "OK" and confirm it.

The program will be saved and the "Standard" menu will be displayed.

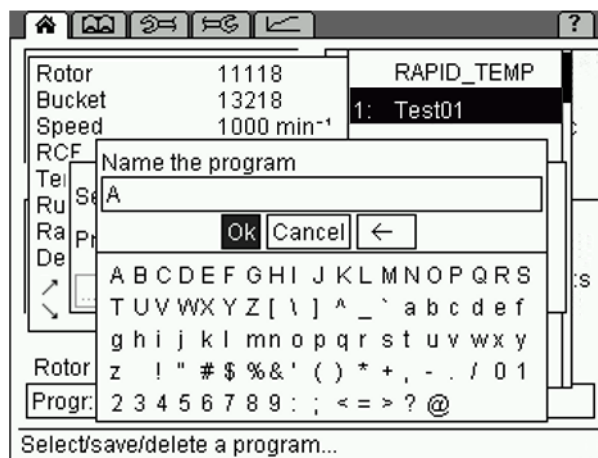



Fig. 30: Assignment of a program name prior to saving the program

6.3.3.2 Loading a program

- Select the option "Progr" from the "Standard" menu  and confirm the selection by pressing the function knob. The program list will be displayed.
- Select the desired program from the list and confirm the selection by pressing the function knob.

Or:

- Open the process library , select the desired program, and confirm the selection by pressing the function knob.

The program will be loaded and the "Standard" menu will be displayed.

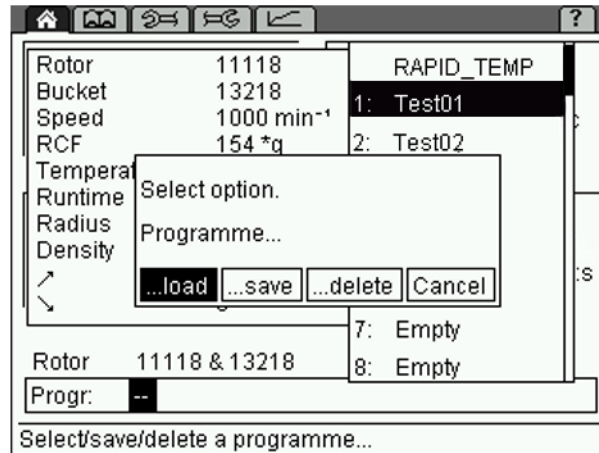



Fig. 31: Loading a program

6.3.3.3 Executing a program

- Select the option "Progr" from the "Standard" menu  and confirm the selection by pressing the function knob. The program list will be displayed.
- Select the desired program from the list and confirm the selection by pressing the function knob.
- Press the start button.

Or:

- Open the process library , select the desired program, and press the start button.

The program will be executed and the "Standard" menu will be displayed.

6.3.3.4 Deleting a program

- Select the option "Progr" in the "Standard" menu  and confirm the selection. The program list will be displayed.
- Select the program that is to be deleted.
- Select the option "Delete" and confirm it.

The program will be deleted and the "Standard" menu will be displayed.

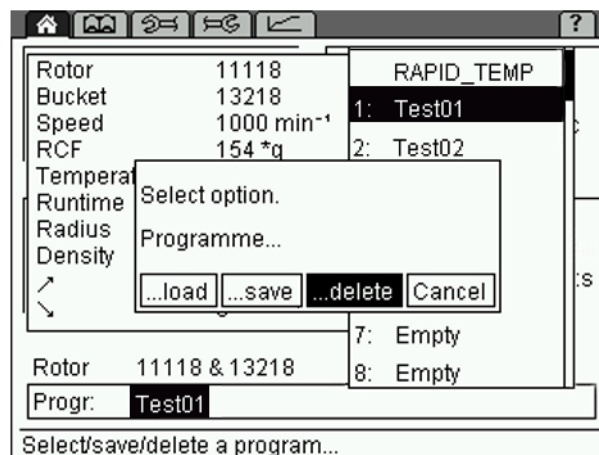



Fig. 32: Deleting a program

6 Using the centrifuge

6.3.3.5 Automatic program rotation

With the automatic program rotation, several programs can be executed directly one after the other.

- Activate the "Program rotation" function in the "Setup" menu .

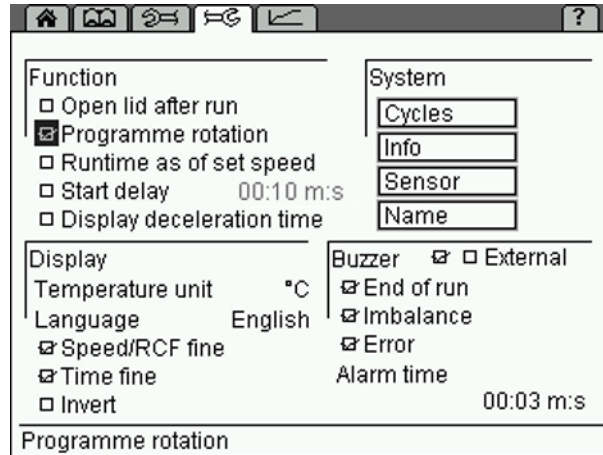

Fig. 33: Program rotation function

When a program is loaded while the program rotation function is active, this program will be used as the start program for the rotation. After the completion of the program, the next program on the program list will be loaded automatically. The rotation continues up to the next empty storage location and then restarts from the beginning (see the following illustration).

Example 1: Loading of Test04

Rotation: Test04, Test05, Test06, Test04,...

Example 2: Loading of Test05

Rotation: Test05, Test06, Test05,...

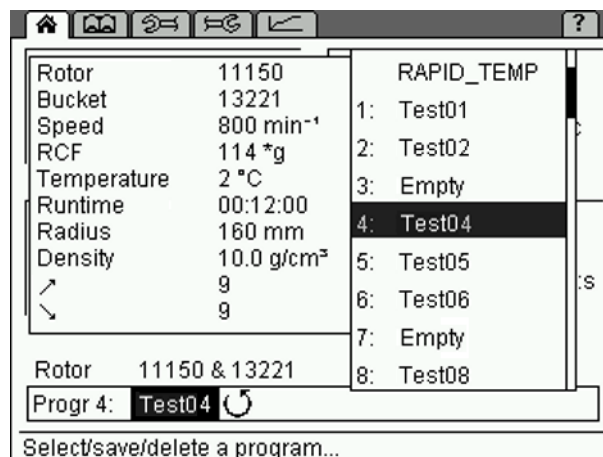

Fig. 34: Automatic program rotation

While the program rotation function is active, the arrow "↻" is displayed in the program line in the "Standard" menu.

6.3.4 Options for data input and output

- Connection for a serial interface (depending on the centrifuge type, partly standard).
- External signal active DC 24V, 0.5 A max. (part no. 17701)
- Floating switch AC 250V max., 6 A (part no. 17702)

6.4 Switching the centrifuge off

- Open the centrifuge when it is not in use so moisture can evaporate.
- Switch the centrifuge off by pressing the mains power switch.

7 Malfunctions and error correction

7 Malfunctions and error correction

7.1 General malfunctions

Malfunctions are indicated by a dialog box. If the acoustic signal is activated, it sounds when the error message is displayed.

- Eliminate the source of the problem (see table below).
- Acknowledge the error messages by pressing the lid key.



Error messages can be eliminated by pressing the lid key. The error itself will not be eliminated, but the centrifuge can be operated again.

Type of error	Possible reason	Correction
No indication on the display	No power in the mains supply	Check fuse in the mains supply
	Power cord is not plugged in	Plug in power cord correctly
	Fuses have tripped	Reactivate temperature fuse (see chapter 5.2.1 - "Type of connection")
	Mains power switch off	Switch mains power switch on
Centrifuge cannot be started: start key LED is not illuminated	Several possible causes	Power off/on. If the error occurs again, contact service
Centrifuge cannot be started: lid key LED flashes	The lid lock is not closed correctly	Open and close the lid. If the error occurs again, contact service
Centrifuge decelerates during operation	Brief mains power failure	Press start key in order to restart the centrifuge
	System error	Power off/on. If the error occurs again, contact service
Centrifuge decelerates during operation, imbalance dialog box is displayed	<ul style="list-style-type: none"> – Improper loading – Centrifuge is inclined – Drive problem – Centrifuge was moved during run 	Balance load and restart the centrifuge. If the error occurs again, contact service
	– Ungreased load- bearing bolts	Clean and grease load- bearing bolts
Lid cannot be opened	Lid lock has not released	Unlock the lid manually (see chapter 7.1.1 - "Emergency lid release") and contact service
	Lid seal sticks	Clean the lid seal and apply talcum powder
Temperature value cannot be reached (only for refrigerated centrifuges)	Condenser dirty (only air-cooled units)	Clean the condenser. If the error occurs again, contact service
Hard running noise during the centrifugation	Screws of the transport safety device are not removed	Remove screws of the transport safety device (see chapter 4.5 - "Transport safety device")

7 Malfunctions and error correction

7.1.1 Emergency lid release

In the event of a power failure, it is possible to manually open the centrifuge lid.

- Switch off the mains power switch and disconnect the power cord from the socket.
- Remove the plugs (see figure, item 1) from the opening on the left and on the right side of the control panel, e.g. with a screwdriver.



Fig. 35: Position of the openings for the emergency lid release

- Insert the supplied hexagon socket key horizontally into the hole. The key will be guided through a funnel-shaped tube to the shaft of the lid lock motor.

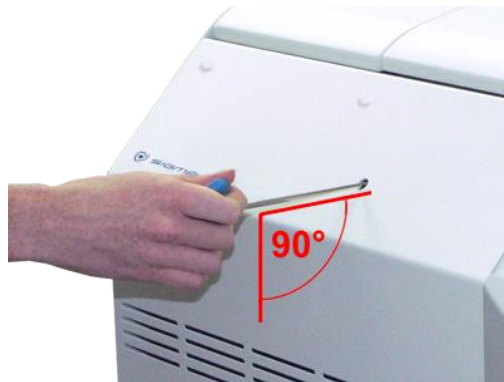

Fig. 36: The emergency lid release key must be inserted horizontally

- Unlock the motorised lid locks as follows:
 - Turn the left lid lock anti-clockwise.
 - Turn the right lid lock clockwise.
- Then, reinsert the plugs.



WARNING

Do not unlock or open the lid unless the rotor is at a standstill.

If the lid is opened via the emergency lid release system during a centrifuge run, the centrifuge will be switched off immediately and decelerate in an unbraked manner.

7 Malfunctions and error correction

7.2 Table of error codes

Error no.	Kind of error	Measures	Note
1-9	System error	<ul style="list-style-type: none"> Allow to slow down Power off/on 	All these errors stop the centrifuge or cause it to decelerate brakeless
10-19	Speedometer error	<ul style="list-style-type: none"> Allow to slow down Power off/on 	
20-29	Motor error	<ul style="list-style-type: none"> Power off Ensure ventilation 	
30-39	EEPROM error	<ul style="list-style-type: none"> Allow to slow down Power off/on 	With error 34, 35, and 36, the centrifuge will stop; with error 37 and 38 only an error message will be given
40-45	Temperature error (only for refrigerated centrifuges)	<ul style="list-style-type: none"> Allow to slow down Power off Allow to cool down Provide better ventilation (only air-cooled centrifuges) Provide sufficient water throughput (only water-cooled centrifuges) 	
46-49	Imbalance error (only for centrifuges with imbalance monitoring system)	<ul style="list-style-type: none"> Allow to slow down Power off Eliminate the imbalance 	
50-59	Lid error	<ul style="list-style-type: none"> Press lid key Close lid Remove foreign matter from the opening of the lid lock device 	With error 50 and 51, the centrifuge will stop
60-69	Process error	<ul style="list-style-type: none"> Allow to slow down Power off/on 	With error 60, the message "power failure during run" will be displayed, with error 61, the message "stop after power on" will be displayed
70-79	Communication error	<ul style="list-style-type: none"> Allow to slow down Power off/on 	
80-89	Parameter error	<ul style="list-style-type: none"> Power off Allow to cool down Provide for better ventilation 	With error 83, error message only
90-99	Other errors	<ul style="list-style-type: none"> Check connections Provide sufficient water throughput (only water-cooled centrifuges) 	



If it is impossible to eliminate the errors, contact the service!

7.3 Service contact

In the event of queries, malfunctions, or spare part enquiries:

From Germany:

Contact

Sigma Laborzentrifugen GmbH
An der Unteren Söse 50
37520 Osterode (Germany)
Tel. +49 (0) 55 22 / 50 07-44 44
E-mail: support.lab@sigma-zentrifugen.de

Outside Germany:

Contact our agency in your country. All agencies are listed at
www.sigma-zentrifugen.de → [Sales Partners]



NOTE

- If you would like to utilise our service, please state the type of your centrifuge and its serial number.

8 Maintenance and service

8 Maintenance and service

The centrifuge, rotor, and accessories are subject to high mechanical stress. Thorough maintenance performed by the user extends the service life and prevents premature failure.



CAUTION

If corrosion or other damage occurs due to improper care, the manufacturer cannot be held liable or subject to any warranty claims.

- Use soap water or other water-soluble, mild cleaning agents with a pH value between 6 and 8 for cleaning the centrifuge and accessories (see also chapter 8.2 - "Sterilisation and disinfection of the rotor chamber and accessories").
- Avoid corrosive and aggressive substances.
- Do not use solvents.
- Do not use agents with abrasive particles.
- Do not expose the centrifuge and rotors to intensive UV radiation or thermal stress (e.g. by heat generators).

8.1 Maintenance

8.1.1 Centrifuge

- Unplug the mains power plug before cleaning.
- Carefully remove all liquids, including water and particularly all the solvents, acids, and alkaline solutions from the rotor chamber using a cloth in order to avoid damage to the motor bearings.
- If the centrifuge has been contaminated with toxic, radioactive, or pathogenic substances, clean the rotor chamber immediately with a suitable decontamination agent (depending on the type of contamination).



WARNING

Take suitable precautions for your own safety if there is a risk of toxic, radioactive, or pathogenic contamination.

- After every cleaning process, grease the motor shaft slightly with a small amount of heavy-duty grease for load-bearing bolts (part no. 71401) and distribute the grease with a cloth so that it forms a thin layer.

8.1.2 Accessories**CAUTION**

For the care of the accessories, special safety measures must be considered as these are measures that will ensure operational safety at the same time!

- Immediately rinse off the rotor, buckets, or accessories under running water if they have come into contact with any liquids that may cause corrosion. Use a brush for test tubes in order to clean the bores of angle rotors. Turn the rotor upside down and allow it to dry completely.
- Clean the accessories outside the centrifuge once a week or preferably after each use. Adapters should be removed, cleaned and dried.

**CAUTION****Do not clean the accessories in a dishwasher!**

Cleaning in a dishwasher removes the anodised coating; the result is cracking in areas that are subject to stress.

- If the rotors or accessories have been contaminated with toxic, radioactive, or pathogenic substances, clean them immediately with a suitable decontamination agent (depending on the type of contamination). Take suitable precautions for your own safety if there is a risk of toxic, radioactive, or pathogenic contamination.
- Dry the accessories with a soft cloth or in a drying chamber at approx. 50°C.

8.1.2.1 Plastic accessories

The chemical resistance of plastic decreases with rising temperatures (see chapter 11.5 - "Resistance data").

- If solvents, acids, or alkaline solutions have been used, clean the plastic accessories thoroughly.

**WARNING**

Plastic accessories must not be greased!

8 Maintenance and service

8.1.3 Rotors, buckets and carriers

Rotors, buckets and carriers are produced with the highest precision, in order to withstand the permanent high stress from high gravitational fields. Chemical reactions as well as stress-corrosion (combination of oscillating pressure and chemical reaction) can affect or destroy the metals. Barely detectable cracks on the surface can expand and weaken the material without any visible signs.

- Check the material regularly (at least once a month) for
 - cracks
 - visible damage of the surface
 - pressure marks
 - signs of corrosion
 - other changes.

- Check the bores of the rotors and multiple carriers.
- Replace any damaged components immediately for your own safety.
- After every cleaning process, grease the rotor tie-down screw slightly with a small amount of heavy-duty grease for load-bearing bolts (part no. 71401) and distribute the grease with a cloth so that it forms a thin layer.

8.1.3.1 Load bearing bolts
Rotors with Sigma "Comfort" rotor coating

The load-bearing bolts of some of the swing-out rotors offered by Sigma Laborzentrifugen GmbH have an anti-friction coating. This coating prevents friction between the buckets and bolts.

The bolts do not require any greasing during the service life of the coating (see chapter 3.6.7.3 - "Service life of the Sigma "Comfort" rotor coating")!

All "Comfort" coated swing-out rotors have a "C" shown after their number (see chapter 3.6.7.1 - "Marking of rotors and accessories").



A portfolio of the available rotors with "Comfort" rotor coating and information on the service life of the coating can be found in the document "Sigma Comfort rotor coating", which is provided with every rotor with "Comfort" rotor coating.

Rotors without Sigma "Comfort" rotor coating

For rotors that do not have or no longer have an anti-friction coating, the load-bearing bolts must be greased. Only greased load-bearing bolts ensure a uniform swing-out of the buckets and, therefore, the smooth operation of the centrifuge. Load-bearing bolts that are insufficiently greased may cause the centrifuge to stop due to an imbalance.

- Clean the load-bearing bolts and bucket groove in order to remove the old grease.
- Apply a small amount of heavy-duty grease for load-bearing bolts (ref. no. 71401, see the following picture) to both load-bearing bolts of a bucket.



Fig. 37: Sufficient quantity of grease for one bolt

- Install the bucket and swing it manually back and forth once in order to distribute the grease.
- Repeat this process with all the other buckets.

8 Maintenance and service

8.1.4 Glass breakage



CAUTION

In the case of glass breakage, immediately remove all glass particles (e.g. with a vacuum cleaner). Replace the rubber cushions since even thorough cleaning will not remove all glass particles.

Glass particles will damage the surface coating (e.g. anodising) of the buckets, which will then lead to corrosion.

Glass particles in the rubber cushions of the buckets will cause glass breakage again.

Glass particles on the pivot bearing of the load-bearing bolts prevent the buckets and carriers from swinging evenly, which will cause an imbalance.

Glass particles in the rotor chamber will cause metal abrasion due to the strong air circulation. This metal dust will not only pollute the rotor chamber, rotor, and materials to be centrifuged but also damage the surfaces of the accessories, rotors, and rotor chamber.

In order to completely remove the glass particles and metal dust from the rotor chamber:

- Grease the upper third of the rotor chamber with e.g. Vaseline.
- Then, let the rotor rotate for a few minutes at a moderate speed (approx. 2000 rpm). The glass and metal particles will now collect at the greased part.
- Remove the grease with the glass and metal particles with a cloth.
- If necessary, repeat this procedure.

8.2 Sterilisation and disinfection of the rotor chamber and accessories

- Use commercially-available disinfectants such as, for example, Sagrotan[®], Buraton[®], or Terralin[®] (available at chemist's shops or drugstores).
- The centrifuge and the accessories consist of various materials. A possible incompatibility must be considered.
- Before using cleaning or decontamination agents that were not recommended by us, contact the manufacturer to ensure that such a procedure will not damage the centrifuge.
- For autoclaving, consider the continuous heat resistance of the individual materials (see chapter 8.2.1 - "Autoclaving").

Please contact us if you have any queries (see chapter 7.3 - "Service contact").



DANGER

If dangerous materials (e.g. infectious and pathogenic substances) are used, the centrifuge and accessories must be disinfected.

8.2.1 Autoclaving

The service life of the accessories essentially depends on the frequency of autoclaving and use.

- Replace the accessories immediately when the parts show changes in colour or structure or in the occurrence of leaks etc.
- During autoclaving, the caps of the tubes must not be screwed on in order to avoid the deformation of the tubes.

NOTE

It cannot be excluded that plastic parts, e.g. lids or carriers, may deform during autoclaving.

Category	Type of accessory	Material abbreviation	121 °C 20 min	134 °C 20 min	Remarks
Rotors and lids	Aluminium rotors	AL	yes	yes	
	Polypropylen rotors	PP	no	no	
	Polycarbonate lids for angle rotors	PC	no	no	
	Polyallomer lids for angle rotors	PA	no	no	
	Polysulfone lids for angle rotors	PSU	yes	yes	100 cycles max.
Buckets and caps	Aluminium buckets	AL	yes	yes	
	Polyamide buckets	PA	no	no	13035, 13296, 13299
	Polyphenylsulfone caps	PPSU	yes	yes	100 cycles max.
	Polysulfone caps	PSU	yes	yes	100 cycles max.
Adapters	Polyallomer carriers	PA	no	no	
	Polycarbonate carriers	PC	no	no	
	Polypropylene carriers	PP	no	no	
Tubes	Stainless steel tubes and bottles	--	yes	no	
	Glass tubes	--	yes	yes	
	Polyethylene tubes	PE	no	no	
	Polyflor tubes	PF	yes	yes	100 cycles max.
	Polycarbonate tubes	PC	no	no	
	Polypropylene copolymer tubes	PPCO	yes	no	20 cycles max.
	Polystyrene tubes	PS	no	no	
Additional equipment	Stainless-steel balance weight for blood-bag systems	--	yes	no	

8 Maintenance and service

8.3 Service



DANGER

In the event of service work that requires the removal of the panels, there is a risk of electric shock or mechanical injury.

- Only qualified specialist personnel is authorised to perform this service work.
- Following the completion of any type of service, the qualified and specialised personnel must perform final inspection and testing in compliance with the relevant standards.

The centrifuge is subject to high mechanical stress. In order to be able to withstand this high level of stress, high-quality components were used during the production of the centrifuge. Nevertheless, wear cannot be excluded and it may not be visible from the outside. Especially the rubber parts that are – among other things – part of the motor suspension, are subject to ageing.

This is why we recommend having the centrifuge checked by the manufacturer during an inspection once per year in the operating state and once every three years in the dismantled state. Motor damping elements must be replaced after three years.

Information and appointments:

In Germany:

Contact

Sigma Laborzentrifugen GmbH

An der Unteren Söse 50

37520 Osterode (Germany)

Tel. +49 (0) 55 22 / 50 07-44 44

E-mail: support.lab@sigma-zentrifugen.de

Outside Germany:

Contact our agency in your country. All agencies are listed at www.sigma-zentrifugen.de → [Sales Partners]



NOTE

- If you would like to utilise our service, please state the type of your centrifuge and its serial number.

8.4 Return of defective centrifuges or parts

Although we exercise great care during the production of our products, it may be necessary to return a unit or accessory to the manufacturer.

In order to ensure the quick and economical processing of returns of centrifuges, spare parts, or accessories, we require complete and extensive information concerning the process. Please fill in the following forms completely, sign them, enclose them with the return package, and send them together with the product to:

Sigma Laborzentrifugen GmbH
An der Unteren Söse 50
37520 Osterode (Germany)

1. Declaration of decontamination

As a certified company and due to the legal regulations for the protection of our employees and of the environment, we are obliged to certify the harmlessness of all incoming goods. For this purpose, we require a declaration of decontamination.

- The form must be filled in completely and signed by authorised and specialised personnel only.
- Affix the original form in a clearly visible manner to the outside of the packaging.



We will return the part/unit if no declaration of decontamination is provided!

2. Form for the return of defective parts

This form is for the product-related data. They facilitate the assignment, and they enable the quick processing of the return. If several parts are returned together in one packaging, please enclose a separate problem description for every defective part.

- A detailed problem description is necessary in order to perform the repair quickly and economically.



If the form does not include a description of the malfunction, neither a refund nor a credit note can be issued. In this case, we reserve the right to return the part/unit to you at your expense.

- Upon request, we will prepare and submit to you a cost estimate prior to performing the repair. Please confirm such cost estimate within 14 days. If the cost estimate has still not been confirmed after 4 weeks, we will return the defective part/unit. Please note that you must bear the incurred costs.

8 Maintenance and service



The defective part/unit must be packaged in a transport-safe manner. Please use the original packaging for the unit, if at all possible. If the product is dispatched to us in unsuitable packaging, you will be charged the cost for returning it to you in new packaging.

The forms can be downloaded online from
www.sigma-zentrifugen.de → [Service] → [Overhaul and repair].

9 Disposal

9.1 Disposal of the centrifuge



In accordance with the directive 2012/19/EU, SIGMA centrifuges are marked with the symbol shown to the left. This symbol means that it is not permissible to dispose of the unit among household waste.

- You can return these centrifuges free of cost to Sigma Laborzentrifugen GmbH.
- Ensure that the unit is decontaminated. Fill in a declaration of decontamination (see chapter 8.4 - "Return of defective centrifuges or parts").
- Comply with any other applicable local rules and regulations.

9.2 Disposal of the packaging

- Use the packaging to return the centrifuge for disposal or
- dispose of the packaging, after having separated the individual materials.
- Comply with all local rules and regulations.

10 Technical data

10 Technical data

Manufacturer:	Sigma Laborzentrifugen GmbH An der Unteren Söse 50 37520 Osterode (Germany)
Type:	6-16HS
<u>Connection requirements</u>	
Electr. connection:	see name plate
Protection class:	I
IP code:	20
Power consumption (kW):	2.0
Input fuse (AT):	16.0 (at 220-240 V / 50 Hz), temperature fuses
<u>Performance data</u>	
Max. speed (rpm):	13,500
Max. capacity (ml):	3,200
Max. gravitational field (x g):	20,376
Max. kinetic energy (Nm):	106,950
<u>Other parameters</u>	
Time range:	10 sec – 99 h 59 min, short run, continuous run
Temperature range:	-20°C to +70°C
Storage locations:	60
<u>Physical data</u>	
Height (mm):	483
Height with open lid (mm):	990
Width (mm):	581
Depth (mm):	711
Weight (kg):	116
Noise level (dB(A)):	< 73 (at maximum speed)

10.1 Ambient conditions

- The figures are valid for an ambient temperature of +23°C and a nominal voltage $\pm 10\%$.



At a nominal voltage of 100V or 200V, a tolerance of +10% / -5% applies.

- For indoor use only.
- Allowable ambient temperature +5°C to +40°C.
- Max. allowable relative humidity of air 80% from 5°C up to 31°C with a linear decrease to 50% relative humidity of air at 40°C.
- Maximum altitude 2,000 m above sea level.

10.2 Technical documentation

For environmental reasons, the comprehensive technical documentation of the centrifuge (e.g. circuit diagrams) and the safety data sheets of the manufacturers of refrigerants and lubricants are not attached to this documentation.

You can order these documents from our service department.

11 Appendix

11 Appendix

11.1 Range of accessories

The complete list of accessories can be downloaded from www.sigma-zentrifugen.de.



Some accessories come supplied together with a data sheet that includes important information and notes on safety. This data sheet must be added to the operating manual.

11.1.1 Rotor radii

The information in the accessories table concerning the radius refers to the values of the respective rotor as shown below. The radius calculation is described in chapter 2.2.2.1 - "Speed, radius, and relative centrifugal force".

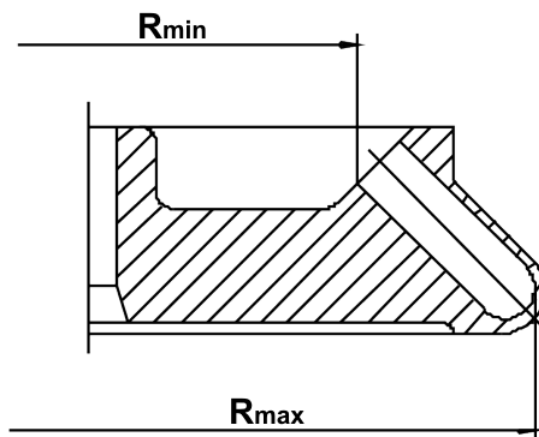

Fig. 38: Minimum and maximum radius of an angle rotor

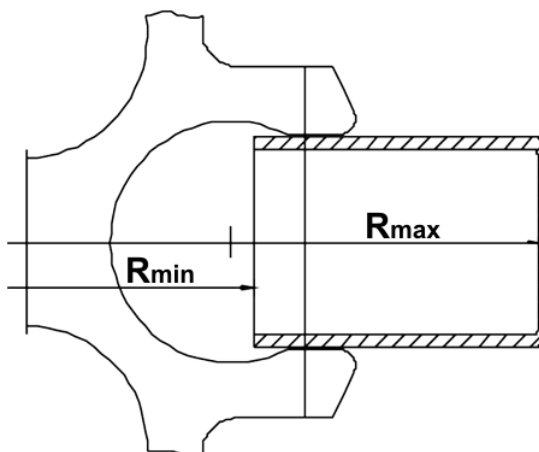

Fig. 39: Minimum and maximum radius of a swing-out rotor

11.2 Speed-gravitational-field-diagram

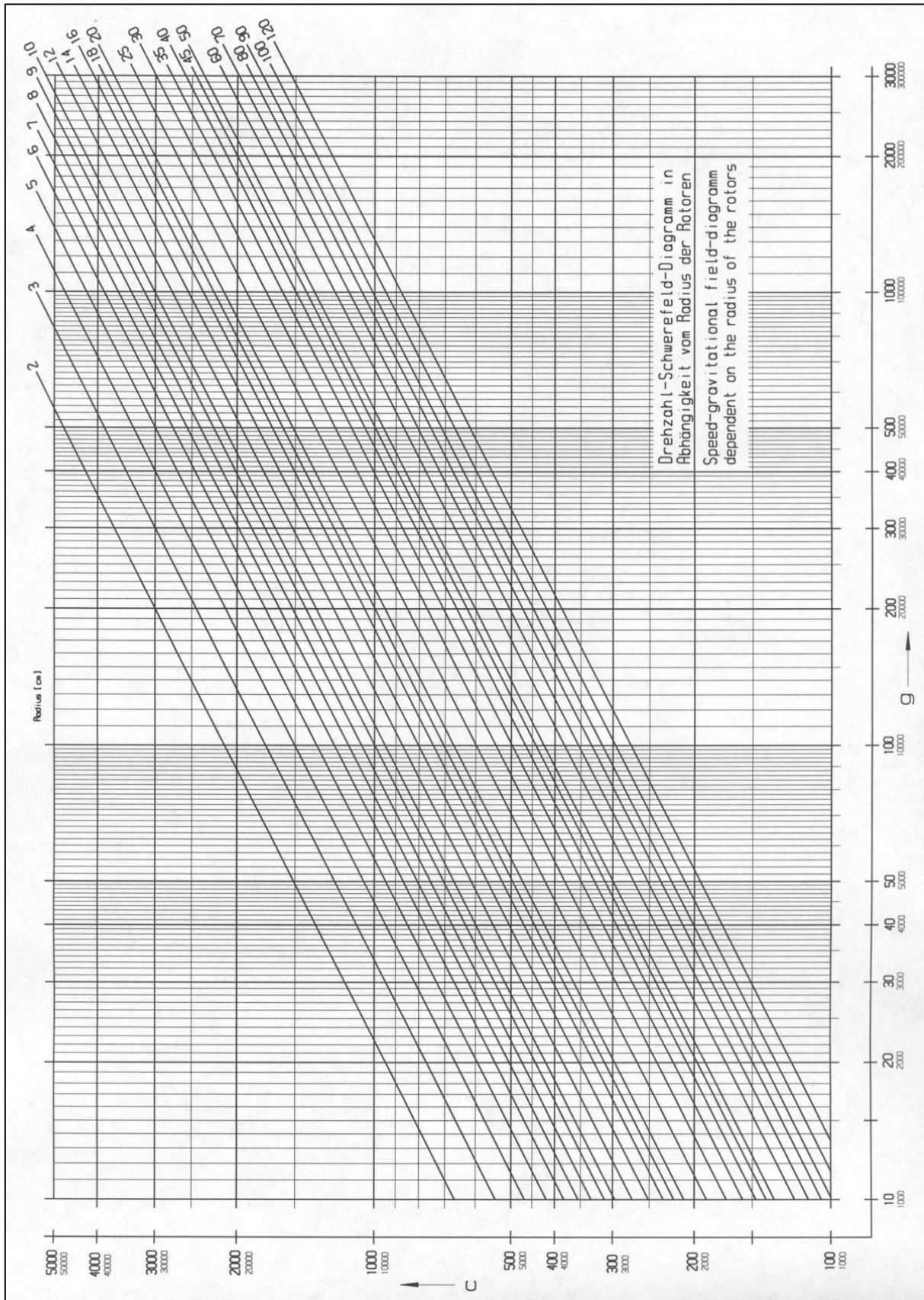

Fig. 40: Speed-gravitational-field-diagram

11 Appendix

11.3 Acceleration and deceleration curves

Linear as well as quadratic curves are numbered in the direction of increasing acceleration (from right to left).

The deceleration curves are inverted images of the acceleration curves and are assigned the same numbers. An exception is curve 0. It decelerates brakeless (spin-out).

In general, the runtime, until the set speed is reached, depends on the moment of inertia of the rotor.

Linear curves

The slope of the fixed acceleration curves defines the time that is required to accelerate the rotor by 1,000 rpm.

Curve 9 is a special case compared to the other curves. The centrifuge accelerates with maximum power. The runtime, until the set speed is reached, depends solely on the moment of inertia of the rotor.

Linear curve no.	Slope
0	4 [rpm/sec]
1	6 [rpm/sec]
2	8 [rpm/sec]
3	17 [rpm/sec]
4	25 [rpm/sec]
5	33 [rpm/sec]
6	50 [rpm/sec]
7	100 [rpm/sec]
8	200 [rpm/sec]
9	1.000 [rpm/sec]

Fig. 41: Slope of linear curves

Quadratic curves

Curve 19 is a special case compared to the other curves. The centrifuge accelerates with maximum power. The runtime depends solely on the moment of inertia of the rotor.

Quadratic curve no.	Time until 1,000 rpm	Slope as of 1,000 rpm
10	500 sec	4 [rpm/sec]
11	333 sec	6 [rpm/sec]
12	250 sec	8 [rpm/sec]
13	118 sec	17 [rpm/sec]
14	80 sec	25 [rpm/sec]
15	60 sec	33 [rpm/sec]
16	40 sec	50 [rpm/sec]
17	20 sec	100 [rpm/sec]
18	10 sec	200 [rpm/sec]
19	2 sec	1.000 [rpm/sec]

Fig. 42: Slope of quadratic curves

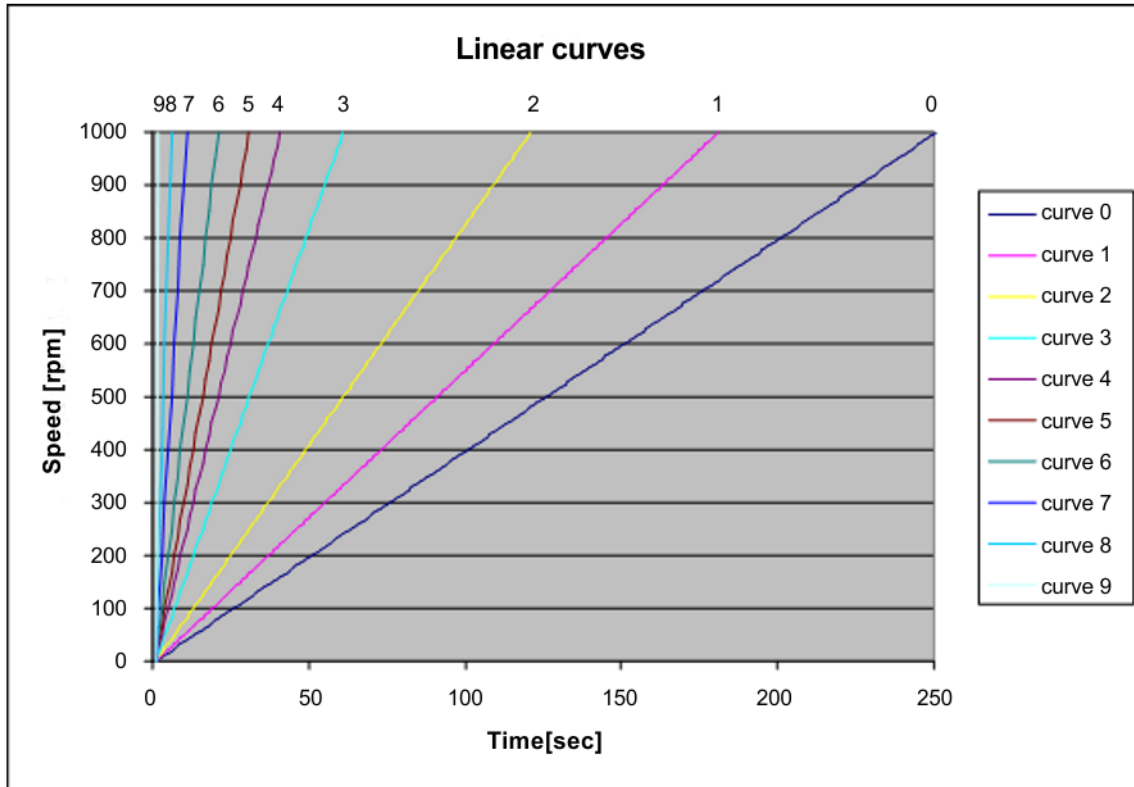

Fig. 43: Diagram of linear curves

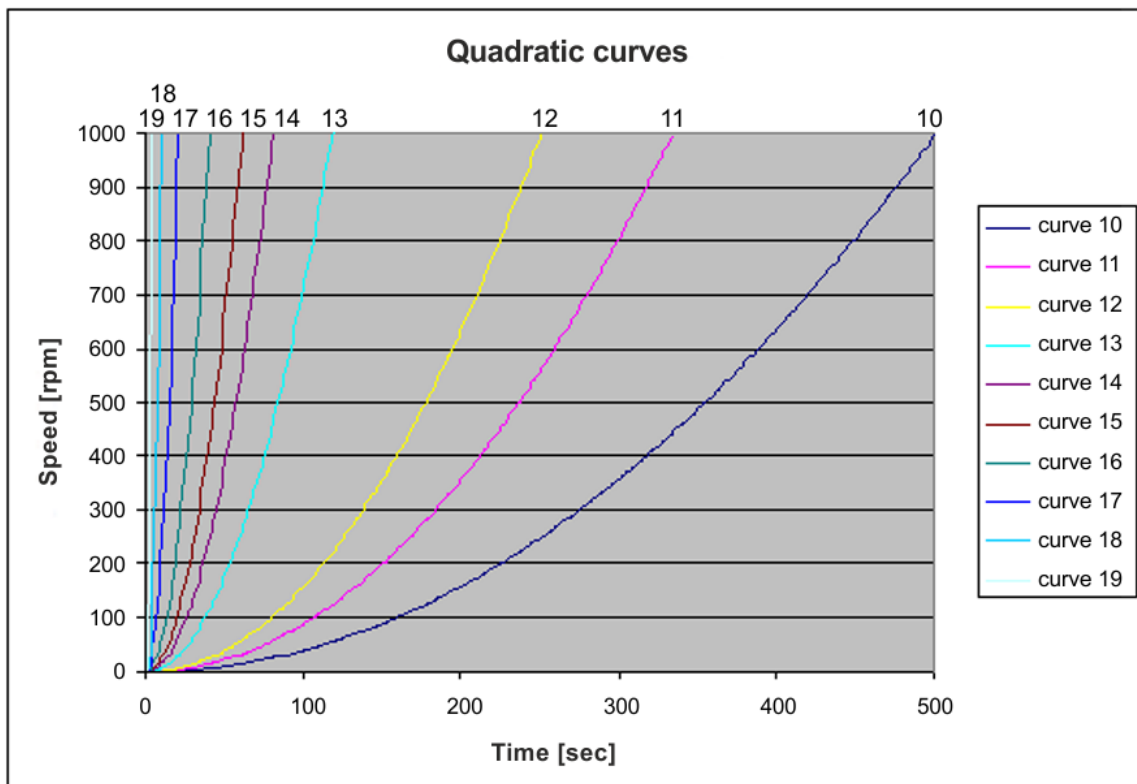

Fig. 44: Diagram of quadratic curves

11 Appendix

11.4 Table of the service life of rotors and accessories

- If no other data concerning the service life are engraved on the rotor or accessory, rotors and buckets must be checked by the manufacturer after 10 years.
- If a specification concerning the maximum number of cycles **and** a specification concerning the service life (i.e. a date) are provided, the specification that occurs first shall apply.
- After 50,000 cycles, rotors must be scrapped for safety reasons.

Rotor / bucket	Cycles	Service life ("Exp.Date")	Suitable for centrifuge	Remarks
9100	35,000		4-16S, 4-16KS, 4-16KHS, 6-16S, 6-16HS, 6-16KS, 6-16KHS	
9366	15,000		4-5KL, 4-16S, 4-16KS, 4-16KHS, 6-16S, 6-16HS, 6-16KS, 6-16KHS	
11805		10 years	8KS, 8KBS	
11806		10 years	8KS, 8KBS	
12082		7 years	1-14, 1-14K	
12083		7 years	1-14, 1-14K	
12084		7 years	1-14, 1-14K	
12085		7 years	1-14, 1-14K	
12092		5 years	1-14, 1-14K	
12093		5 years	1-14, 1-14K	
12094		5 years	1-14, 1-14K	
12096		5 years	1-14, 1-14K	
12097		5 years	1-14, 1-14K	
12134		5 years	1-16, 1-16K	
12135		5 years	1-16, 1-16K	
12137		5 years	1-16, 1-16K	
12500		7 years	6-16S, 6-16HS, 6-16KS, 6-16KHS	
12600		7 years	6-16S, 6-16HS, 6-16KS, 6-16KHS	
13035			2-7	Do not grease the load-bearing bolts of the rotor
13218	20,000		4-16S, 4-16KS, 4-16KHS, 6-16S, 6-16HS, 6-16KS, 6-16KHS	
13221	10,000		4-16S, 4-16KS, 4-16KHS, 6-16S, 6-16HS, 6-16KS, 6-16KHS	
13296	35,000	5 years	2-7, 2-16P, 2-16KL, 2-16KHL	Do not grease the load-bearing bolts of the rotor
13299		5 years	2-7, 2-16P, 2-16KL, 2-16KHL, 3-30KS, 3-30KHS	Do not grease the load-bearing bolts of the rotor
13635	25,000		6-16S, 6-16HS, 6-16KS, 6-16KHS	
13650	20,000		6-16S, 6-16HS, 6-16KS, 6-16KHS	
13845	20,000		8KS	
13850	10,000	10 years	8KS	
13860	15,000	10 years	8KBS	
91060	10,000		6-16S, 6-16HS	Special software required

11.5 Resistance data



The data refer to resistance at 20°C.

- no data 1 resistant 2 practically resistant 3 partially resistant 4 not resistant	Concentration	High Density Polyethylene	Polyamide	Polycarbonate	Polyoxymethylene	Polypropylene	Polysulfone	Polyvinyl chloride, hard	Polyvinyl chloride, soft	Polytetrafluorethylene	Acrylonitrile-butadiene-caoutchouc	Aluminium	
													Medium
Acetaldehyde	C ₂ H ₄ O	40	3	2	4	2	3	4	4	-	1	4	1
Acetamide	C ₂ H ₅ NO	saturated	1	1	4	1	1	4	4	-	1	-	1
Acetone	C ₃ H ₆ O	100	1	1	4	1	1	4	4	-	1	4	1
Acrylonitrile	C ₃ H ₃ N	100	1	1	4	3	3	4	4	4	1	4	1
Allyl alcohol	C ₃ H ₆ O	96	1	3	3	2	2	2	2	4	1	1	1
Aluminium chloride	AlCl ₃	saturated	1	3	2	4	1	-	1	-	1	1	4
Aluminium sulfate	Al ₂ (SO ₄) ₃	10	1	1	1	3	1	1	1	1	1	1	1
Ammonium chloride	(NH ₄)Cl	aqueous	1	1	1	2	1	1	1	1	1	1	3
Ammonium hydroxide	NH ₃ + H ₂ O	30	1	3	4	1	1	2	1	-	1	-	1
Aniline	C ₆ H ₇ N	100	1	3	4	1	2	4	4	4	1	4	1
Anisole	C ₇ H ₈ O	100	3	4	4	1	4	4	2	-	1	4	1
Antimony trichloride	SbCl ₃	90	1	4	1	4	1	-	1	-	1	-	4
Benzaldehyde	C ₇ H ₆ O	100	1	3	4	1	1	3	4	4	1	4	1
Benzene	C ₆ H ₆	100	3	2	4	1	3	4	4	-	1	4	1
Boric acid	H ₃ BO ₃	aqueous	1	3	1	2	1	-	-	-	1	1	1
Butyl acrylate	C ₇ H ₁₂ O ₂	100	1	2	4	2	3	4	4	4	1	-	1
Butyl alcohol, normal	C ₄ H ₁₀ O	100	1	1	2	1	1	2	2	4	1	1	1
Calcium chloride	CaCl ₂	alcoholic	1	4	2	3	1	-	-	4	1	1	3
Carbon disulfide	CS ₂	100	4	3	4	2	4	4	4	4	1	3	1
Carbon tetrachloride (TETRA)	CCl ₄	100	4	4	4	2	4	4	4	4	1	3	1
Chlorine	Cl ₂	100	4	4	4	4	4	4	4	4	1	-	3
Chlorine water	Cl ₂ x H ₂ O		3	4	4	4	3	-	3	3	1	-	4
Chlorobenzene	C ₆ H ₅ Cl	100	3	4	4	1	3	4	4	4	1	4	1
Chloroform	CHCl ₃	100	3	3	4	4	3	4	4	4	1	4	3

11 Appendix

- no data 1 resistant 2 practically resistant 3 partially resistant 4 not resistant	Medium	Formula	Concentration [%]	High Density Polyethylene	Polyamide	Polycarbonate	Polyoxymethylene	Polypropylene	Polysulfone	Polyvinyl chloride, hard	Polyvinyl chloride, soft	Polytetrafluorethylene	Acrylonitrile-butadiene- caoutchouc	Aluminium
				HDPE	PA	PC	POM	PP	PSU	PVC	PVC	PTFE	NBR	AL
	Chromic acid	CrO ₃	10	1	4	2	4	1	4	1	-	1	4	1
	Chromic potassium sulphate	KCr(SO ₄) ₂ x 12H ₂ O	saturated	1	2	1	3	1	-	1	-	1	-	3
	Citric acid	C ₆ H ₈ O ₇	10	1	1	1	2	1	1	1	1	1	1	1
	Citric acid	C ₆ H ₈ O ₇	50	1	3	1	2	1	-	-	-	1	1	1
	Copper sulphate	CuSO ₄ x 5H ₂ O	10	1	1	1	1	1	1	1	1	1	1	4
	Cyclohexanol	C ₆ H ₁₂ O	100	1	1	3	1	1	1	1	4	1	2	1
	Decane	C ₁₀ H ₂₂	100	-	1	2	1	3	-	-	-	1	2	1
	Diaminoethane	C ₂ H ₈ N ₂	100	1	1	3	1	1	-	3	4	1	1	1
	Diesel fuel	—	100	1	1	3	1	1	-	1	3	1	1	1
	Dimethyl formamide (DMF)	C ₃ D ₇ NO	100	1	1	4	1	1	4	3	-	1	3	1
	Dimethyl sulfoxide (DMSO)	C ₂ H ₆ SO	100	1	2	4	1	1	4	4	-	1	-	1
	Dimethylaniline	C ₈ H ₁₁ N	100	-	3	4	2	4	-	-	-	1	-	1
	Dioxane	C ₄ H ₈ O ₂	100	2	1	4	1	3	2	3	4	1	3	1
	Dipropylene glycol (mono)methyl ether	C ₄ H ₁₀ O	100	3	1	4	1	4	4	4	4	1	-	1
	Ethyl acetate	C ₄ H ₈ O ₂	100	1	1	4	1	1	4	4	4	1	4	1
	Ethylene chloride	C ₂ H ₄ Cl ₂	100	3	3	4	1	3	4	4	4	1	-	1
	Ferrous chloride	FeCl ₂	saturated	1	3	1	3	1	1	1	1	1	-	4
	Formaldehyde solution	CH ₂ O	30	1	3	1	1	1	-	-	-	1	2	1
	Formic acid	CH ₂ O ₂	100	1	4	3	4	1	3	3	1	1	2	1
	Furfural	C ₅ H ₄ O ₂	100	1	3	3	2	4	-	-	-	1	4	1
	Gasoline	C ₅ H ₁₂ - C ₁₂ H ₂₆	100	2	1	3	1	3	3	2	-	1	1	1
	Glycerol	C ₃ H ₈ O ₃	100	1	1	3	1	1	1	1	2	1	1	1
	Heptane, normal	C ₇ H ₁₆	100	2	1	1	1	2	1	2	4	1	1	1
	Hexane, n-	C ₆ H ₁₄	100	2	1	2	1	2	1	2	4	1	1	1
	Hydrogen chloride	HCl	5	1	4	1	4	1	1	1	-	1	2	4
	Hydrogen chloride	HCl	concentrated	1	4	4	4	1	1	2	3	1	4	4
	Hydrogen peroxide	H ₂ O ₂	3	1	3	1	1	1	1	1	-	1	3	3
	Hydrogen peroxide	H ₂ O ₂	30	1	4	1	4	1	1	1	-	1	3	3
	Hydrogen sulphide	H ₂ S	10	1	1	1	1	1	1	1	3	1	3	1
	Iodine, tincture of	I ₂		1	4	3	1	1	-	4	4	1	1	1

11 Appendix

- no data 1 resistant 2 practically resistant 3 partially resistant 4 not resistant	Medium	Formula	Concentration [%]	High Density Polyethylene	Polyamide	Polycarbonate	Polyoxymethylene	Polypropylene	Polysulfone	Polyvinyl chloride, hard	Polyvinyl chloride, soft	Polytetrafluorethylene	Acrylonitrile-butadiene- caoutchouc	Aluminium
				HDPE	PA	PC	POM	PP	PSU	PVC	PVC	PTFE	NBR	AL
	Isopropyl alcohol	C ₃ H ₈ O	100	1	1	1	1	1	1	1	4	1	-	2
	Lactic acid	C ₃ H ₆ O ₃	3	1	3	1	2	1	1	2	-	1	1	1
	Magnesium chloride	MgCl ₂	10	1	1	1	1	1	1	1	1	1	1	1
	Mercuric chloride	HgCl ₂	10	1	4	1	3	1	1	1	1	1	1	4
	Mercury	Hg	100	1	1	1	1	1	1	1	3	1	1	3
	Methyl acetate	C ₃ H ₆ O ₂	100	1	1	4	2	1	-	4	4	1	-	1
	Methyl alcohol	CH ₄ O	100	1	2	4	1	1	3	1	3	1	2	1
	Methyl benzene	C ₇ H ₈	100	3	1	4	1	3	4	4	4	1	4	1
	Methyl ethyl ketone (MEK)	C ₄ H ₈ O	100	1	1	4	1	1	4	4	4	1	4	1
	Methylene chloride	CH ₂ Cl ₂	100	4	3	4	3	3	4	4	4	1	-	1
	Mineral oil	—	100	1	1	1	1	1	1	1	-	1	1	1
	Nitric acid	HNO ₃	10	1	4	1	4	1	1	1	-	1	4	3
	Nitric acid	HNO ₃	100	4	4	4	4	4	-	4	-	1	4	1
	Nitrobenzene	C ₆ H ₅ NO ₂	100	3	4	4	3	2	4	4	4	1	4	1
	Oleic acid	C ₁₈ H ₃₄ O ₂	100	1	1	1	2	1	-	1	-	1	3	1
	Oxalic acid	C ₂ H ₂ O ₄ x 2H ₂ O	100	1	3	1	4	1	1	1	1	1	2	1
	Ozone	O ₃	100	3	4	1	4	3	1	1	-	1	4	2
	Petroleum	—	100	1	1	3	1	1	1	1	3	1	1	1
	Phenol	C ₆ H ₆ O	10	1	4	4	4	1	4	1	3	1	3	1
	Phenol	C ₆ H ₆ O	100	2	4	4	4	1	3	4	3	1	3	1
	Phosphoric acid	H ₃ PO ₄	20	1	4	2	4	1	-	-	-	1	2	4
	Phosphorus pentachloride	PCl ₅	100	-	4	4	4	1	-	4	4	1	-	1
	Potassium hydrogen carbonate	CHKO ₃	saturated	1	1	2	1	1	-	-	-	1	-	4
	Potassium hydroxide	KOH	30	1	1	4	3	1	1	1	1	1	-	4
	Potassium hydroxide	KOH	50	1	1	4	3	1	1	1	1	1	-	4
	Potassium nitrate	KNO ₃	10	1	1	1	1	1	-	-	-	1	1	1
	Potassium permanganate	KMnO ₄	100	1	4	1	1	1	-	1	-	1	3	1
	Pyridine	C ₅ H ₅ N	100	1	1	4	1	3	4	4	4	1	4	1
	Resorcinol	C ₆ H ₆ O ₂	5	1	4	2	3	1	4	2	-	1	-	2
	Silver nitrate	AgNO ₃	100	1	1	1	1	1	1	1	1	1	2	4

11 Appendix

- no data 1 resistant 2 practically resistant 3 partially resistant 4 not resistant		Concentration	High Density Polyethylene	Polyamide	Polycarbonate	Polyoxymethylene	Polypropylene	Polysulfone	Polyvinyl chloride, hard	Polyvinyl chloride, soft	Polytetrafluorethylene	Acrylonitrile-butadiene-caoutchouc	Aluminium
			Medium	Formula	[%]	HDPE	PA	PC	POM	PP	PSU	PVC	PVC
	Sodium bisulphite	NaHSO ₃	10	1	1	2	4	1	-	-	1	1	1
	Sodium carbonate	Na ₂ CO ₃	10	1	1	1	1	1	-	-	1	-	3
	Sodium chloride	NaCl	30	1	1	1	1	1	1	1	1	1	3
	Sodium hydroxide	NaOH	30	1	1	4	1	1	1	1	1	2	4
	Sodium hydroxide	NaOH	50	1	1	4	1	1	1	1	1	2	4
	Sodium sulfate	Na ₂ SO ₄	10	1	1	1	1	1	1	1	1	1	1
	Spirits	C ₂ H ₆ O	96	1	1	1	1	1	1	3	1	-	1
	Styrene	C ₈ H ₈	100	4	1	4	1	3	-	4	4	4	1
	Sulphuric acid	H ₂ SO ₄	6	1	4	1	4	1	1	1	1	2	3
	Sulphuric acid	H ₂ SO ₄	fuming	4	4	4	4	4	4	4	4	4	3
	Tallow	—	100	1	1	1	1	1	-	1	1	1	1
	Tetrahydrofuran (THF)	C ₄ H ₈ O	100	3	1	4	1	3	4	4	4	3	1
	Tetrahydronaphthalene	C ₁₀ H ₁₂	100	3	1	4	1	4	4	4	4	-	1
	Thionyl chloride	Cl ₂ SO	100	4	4	4	2	4	4	4	4	-	3
	Tin chloride	SnCl ₂	10	1	4	2	2	1	-	-	1	1	4
	Transformer oil	—	100	1	1	3	3	1	1	1	1	1	1
	Trichloroethane	C ₂ H ₃ Cl ₃	100	3	3	4	2	4	4	4	4	4	4
	Urea	CH ₄ N ₂ O	10	1	1	1	1	1	-	-	1	1	1
	Urine	—	100	1	1	1	1	1	-	1	1	-	2
	Vinegar	C ₂ H ₄ O ₂	10	1	4	1	1	1	1	1	1	2	1
	Vinegar	C ₂ H ₄ O ₂	90	1	4	4	4	1	3	1	4	-	1
	Wax	—	100	-	1	1	1	1	-	-	1	-	1
	Wines	—	100	1	1	1	2	1	1	1	1	-	4
	Xylene	C ₈ H ₁₀	100	3	1	4	1	4	4	4	4	4	1

11.6 EC declaration of conformity



EC – DECLARATION OF CONFORMITY

The product named hereinafter was developed, designed, and manufactured in compliance with the relevant, fundamental safety and health requirements of the listed EC directives and norms.

In the event of modifications that were not authorised by us or if the product is used in a manner that is not in line with the intended purpose, this declaration will be rendered void.

<i>Product name:</i>	Laboratory centrifuge
<i>Product type:</i>	Sigma 6-16S, 6-16HS
<i>Order number:</i>	10390, 10391, 10392, 10393
<i>Directives:</i>	2006/42/EC Machinery Directive 2014/35/EU Low Voltage Directive 2014/30/EU EMC Directive (EU) 2015/863 RoHS Directive
<i>Normes:</i>	EN 61010-2-020:2017 EN IEC 61000-3-2:2019 EN 61000-3-3:2020 EN 61326-1:2013

Sigma Laborzentrifugen GmbH

An der Unteren Söse 50
37520 Osterode
Germany

Authorised representative
for CE matters:
Eckhard Tödteberg

Osterode, 22/02/2022



General Manager

11 Appendix

11.7 Declaration of conformity – China RoHS 2



DECLARATION OF CONFORMITY

China RoHS 2 (Administrative Measures for the Restriction of the Use of Hazardous Substances in Electrical and Electronic Products)

Laboratory centrifuge models: Sigma 1-14, 1-14K, 1-7, 1-16, 1-16K, 2-7, 2-16P, 2-16KL, 2-16KHL, 3-16L, 3-16KL, 3-18KS, 3-18KHS, 3-30KS, 3-30KHS, 4-5L, 4-5KL; 4-5KRL, 4-16S, 4-16KS, 4-16KHS, 6-16S, 6-16HS, 6-16KS, 6-16KHS, 8KS, 8KBS

Sigma Laborzentrifugen GmbH has made reasonable effort to avoid the use of hazardous substances in the products it manufactures (laboratory centrifuges).

A Product Conformity Assessment (PCA) was performed in order to determine whether the concentration of harmful substances in all homogeneous materials of the component parts is above or below the MCV limit (Maximum Concentration Value limit) as defined in GB/T 26572:

Mercury and its compounds: 0.1 % Cadmium (Cd) and its compounds: 0.01 %
 Lead (Pb) and its compounds: 0.1 % Hexavalent chromium (Cr (VI)) and its compounds: 0.1 %
 Polybrominated biphenyls (PBB): 0.1 % Polybrominated diphenyl ethers (PBDE): 0.1 %

表1 产品中有害物质的名称及含量
 Table 1: Name and content of hazardous substances in the product

部件名称 Component part (PCA)	有害物质 Hazardous substance					
	铅 Lead (Pb)	汞 Mercury (Hg)	镉 Cadmium (Cd)	六价铬 Hexavalent Chromium (Cr (VI))	多溴联苯 Poly-brominated biphenyls (PBB)	多溴二苯醚 Polybrominated diphenyl ethers (PBDE)
Electronic PCB, cables	X ¹⁾	○	○	○	○	○
Display	○	○	○	○	○	○
Housing	X ²⁾	○	○	○	○	○
Base, metal, accessories	X ²⁾	○	○	○	○	○

本表格依据SJ/T 11364的规定编制。
 This table is made according to SJ/T 11364.

11 Appendix



- O: 表示该有害物质在该部件所有均质材料中的含量均在GB/T 26572规定的限量要求以下。
Indicates that the content of the harmful substance in all homogeneous materials of the component part is below the limit as defined in GB/T 26572.)
- X: 表示该有害物质至少在该部件的某一均质材料中的含量超出GB/T 26572规定的限量要求。(企业可在此处, 根据实际情况对上表打“X”的技术原因进行进一步说明。)
Indicates that the content of the harmful substance in at least one homogeneous material of the component part exceeds the limit as defined in GB/T 26752. (Contact the manufacturer for further technical information according to the actual situation.)
- 1) Contains parts in compliance with exemptions 6c, 7c.I, 7c.II and 37 of 2011/65/EU RoHS.
- 2) Contains parts in compliance with exemptions 6a, 6b and 6c of 2011/65/EU RoHS.

Apart from the exemptions given in this table, none of the substances listed above have been intentionally added to the product or metallic coatings.

Sigma Laborzentrifugen GmbH

An der Unteren Söse 50
37520 Osterode
Germany

Osterode, 08/11/2023



M. Weigoni, Director of Procurement

11.8 UKCA declaration of conformity



UKCA – DECLARATION OF CONFORMITY

The product named hereinafter was developed, designed, and manufactured in compliance with the relevant, fundamental safety and health requirements of the listed directives and norms.

In the event of modifications that were not authorised by us or if the product is used in a manner that is not in line with the intended purpose, this declaration will be rendered void.

<i>Product name:</i>	Laboratory centrifuge
<i>Product type:</i>	Sigma 6-16S, Sigma 6-16HS
<i>Order number:</i>	10390, 10393
<i>Manufacturer:</i>	Sigma Laborzentrifugen GmbH An der Unteren Söse 50 37520 Osterode am Harz Germany
<i>Directives:</i>	Supply of Machinery (Safety) Regulations 2008 Electrical Equipment (Safety) Regulations 2016 Electromagnetic Compatibility Regulations 2016 Restriction of the Use of Certain Hazardous Substances in Electrical and Electronic Equipment Regulations 2012
<i>Normes:</i>	EN 61010-2-020:2017 EN IEC 61000-3-2:2019 EN 61000-3-3:2020 EN 61326-1:2013

UK Authorised Representative:

**UK
CA** SciQuip Ltd
Newtown
Wem
Shropshire
SY4 5NU

Osterode, 08/12/2022

Michael Sander
General Manager

11 Appendix

12 Index

A

Acceleration	48
Acceleration curve	48, 59, 84
Acceleration curve (changing)	59
Acceleration curve (creating)	59
Accessories	
changes in colour	75
changes in structure	75
deformation of tubes	75
Leaks	75
marking	23
Accessories, cleaning and care	71
Acid	22, 70, 71
Acoustic signal	66
Activating the help function	60
Adapters	40, 71
Alkaline solutions	22, 70, 71
Ambient conditions	80
Ambient temperature	80
Anodised coating	71
Anti-friction coating	73
Application examples	13
ASTM standard	42
Autoclaving	75
Automatic lid opening function	56
Automatic program rotation	64
Automatic rotor identification	47

B

Batch number and serial number of rotors and accessories	23
Blocking a function	54
Blood bag systems	41
Brake	48
Brakeless deceleration	48
Brakeless deceleration from set speed	54
Brief mains power failure	66
Bucket	40
Buckets, cleaning and care	72
Buzzer/signal	58

C

Capacity	80
Carrier	40
Carrier systems	40
Carriers, cleaning and care	72
CE mark in compliance with the directive 2006/42/EC	15
Centrifugation monitoring	53
Centrifugation of blood bag systems	41
Centrifugation of infectious, toxic, radioactive, or pathogenic substances	21
Centrifugation principle	13
Centrifugation with low capacity	39
Centrifugation with tubes in compliance with ASTM standard D91/D96	42
Centrifugation with vessels of various sizes	38
Centrifuge cannot be started	66
Centrifuge decelerates during operation	66
Centrifuge is inclined	66
Centrifuge was moved during run	66
Centrifuge, cleaning and care	70
Centrifuges	
- definition	9
Changes in colour (accessories)	75
Changes in structure (accessories)	75
Changing an acceleration curve	59
Changing the code	55
Chemical and biological safety	21
Chemical resistance of plastic	71
China RoHS 2 – Declaration of conformity	93
Cleaning agents	74
Cleaning the bores of angle rotors	71
Cleaning the centrifuge	70
Closing the lid	20, 34
Comfort rotor coating	25
Communication error	68
Condensation	32
Condenser dirty	66
Contamination	21, 71
Continuous heat resistance	74
Continuous run	46

Index

Contrast (changing)	61	Electrical connection	80
Control system	43	Electrical safety	20
Copyright	10	Emergency lid release	67
Corrosion	20, 24, 40, 70, 71, 72, 74	Error correction	66
Cost estimate	77	Error message	66
Cracking	71	Executing a program	63
Cracks	72	Explanation of the symbols and notes	16
Creating an acceleration curve	59	Explosive substances	21
Curve menu	59	External signal	58
Customer-provided fuses	33	F	
Cycles	35, 58	Fire preventions	21
D		Form for the return of defective parts	77
Damage of the surface	72	Function	56
Dangerous goods	22	Functional and operating elements	11
Dangerous materials	74	Fuses have tripped	66
Date of manufacture	12	G	
Deactivating the help function	60	General conditions	9
Deceleration	48	Glass breakage	74
Deceleration curve	48, 59, 84	Glass particles	74
Declaration of conformity	10, 91	Gravitational field	80
Declaration of conformity – China RoHS 2	93	Grease for load-bearing bolts	70, 73
Declaration of decontamination	77, 79	H	
Decontamination agent	71, 74	Hard running noise during the centrifugation	66
Deformation of tubes (accessories)	75	Hazard warnings	9, 35, 36, 40
Deleting a program	63	Heavy-duty grease for load-bearing bolts	73
Density	12, 22, 52	Help function	60
Dialog box	27	Hexagon socket wrench	10
Different service life of rotors and accessories	24, 86	Highly corrosive substances	21
Dimensions	29	I	
Direct hazard to the life and health	16	Imbalance	38, 40
Directive 2002/96/EC	79	Imbalance error	68
Disinfectants	74	Imbalance monitoring system	27
Disinfection of the rotor chamber and accessories	74	Importance of the operating manual	9
Display	43, 57	Important information	16
Display deceleration time	57	Improper loading	66
Disposal of the centrifuge	79	Infectious substances	74
Disposal of the packaging	79	Inflammable substances	21
Documentation	10	Informal safety instructions	19
Drive problem	66	Initial start-up	34
E		Input fuse	80
Earth conductor check	27	Inspection by the manufacturer	76
EC declaration of conformity	10, 91	Installation of a rotor	35
EEPROM error	68	Installation of accessories	38

Installation of an angle rotor with a hermetic lid	36	Menu Processlibrary	51
Installation of rotors and accessories	35	Menu Setup	56
Installation site	32	Menu Standard	45
Insufficiently greased load-bearing bolts	73	Mode of operation	13
Intended use	9	Modification mode active.....	44
Interrupting a centrifugation run	44	Motor error	68
Interrupting a deceleration process	44	Motor shaft.....	35, 36, 70
Invert.....	57	Multiple carrier	40
IP code	80	N	
K		Name plate	11, 12
Kinetic energy	12, 80	No indication on the display	66
L		No power in the mains supply	66
Language.....	57	Noise level	80
Layout of the centrifuge.....	11	Nominal voltage	12
Leaks (accessories	75	Notes on safety and hazards	9
Lid cannot be opened	66	Notes on transport	29
Lid error	68	O	
Lid lock device	27	Online download of forms	78
Lid lock has not released	66	Open lid after run	56
Lid seal sticks	66	Opening the lid.....	34
Limit "Delta T"	53	Operating personnel	18
Linear curves	84	Operating voltage.....	32
Loading a process.....	51	Operational safety.....	71
Loading a program.....	62	Option for the input and output of data	58
Lock.....	54	Options for data input and output	65
M		Overseas shipping	29
Mains power switch off.....	66	P	
Mains switch	11	Packaging	30
Mains voltage.....	20	Parameter error	68
Maintenance	70	Parameters menu	52
Malfunctions and error correction.....	66	Pathogenic substances.....	21, 70, 74
Manual mode	44	Plastic accessories, cleaning and care.....	71
Manufacturer.....	80	Potential hazard to the life and health	16
Marking of rotors and accessories	23	Potentially hazardous situation.....	16
Marking of the rotors	73	Power consumption	12, 80
Marking of the unit	15	Power cord is not plugged in	66
Maximum speed for tubes.....	40	Power supply	32
Measures in the event of hazards and accidents.....	28	Pressure marks.....	72
Mechanical safety	20	Prevention of accidents.....	9
Menu Curve	59	Problem description	77
Menu Help	60	Process.....	52
Menu Parameters	52	Process error	68
		Process library	51
		Program "RAPID_TEMP"	49

Index

Program list.....	48, 62, 63	Runtime as of set speed	56
Program mode	61	S	
Program rotation	56	Safety area	22
Programm "ASTM oil"	48	Safety devices	27
Progress indicator	50	Safety distance	20
Protection class	32, 80	Safety instructions.....	9, 35, 36, 40
Q		Safety instructions concerning the centrifugation process	22
Quadratic curves.....	84	Safety of rotors and accessories	23
Qualified electrician.....	18	Safety range	22, 32
Quick stop.....	44	Safety, chemical and biological	21
R		Safety, electrical	20
Radioactive substances	21, 70	Safety, mechanical.....	20
Radius	14, 52	Safety-conscious work	17
RAPID_TEMP program.....	49	Saving a program.....	62
RCF	45	Scope of supply	10
Relative centrifugal force.....	45	Screws of the transport safety device are not removed	66
Relative centrifugal force (RCF).....	14	Selection, display, and modification of data	44
Removal of the transport safety device	30	Serial number	12, 69, 76
Remove glass particles and metal dust from the rotor chamber	74	Serial number of rotors.....	23
Removing a rotor	35, 37	Service.....	76
Requirements concerning the personnel....	18	Service contact	69
Responsibility of the operator.....	17	Service life	70
Return of centrifuges, spare parts, or accessories	77	Service life of rotors and accessories...	24, 86
Return of defective parts	77	Service life of the accessories.....	75
Rotor chamber	70	Service work	76
Rotor coating Sigma "Comfort"	25	Set-up and connection	32
Rotor identification, automatic.....	47	Setup menu	56
Rotor monitoring system	27	Short run.....	46
Rotor radii	82	Sigma	25, 73
Rotor removal	37	Solvents.....	22, 70, 71
Rotor selection list.....	47	Sound signal	27
Rotor tie-down screw	35, 36, 72	Sound signal (warning)	58
Rotor wrench	10, 35, 36	Spare part enquiries.....	69
Rotors		Specialised personnel.....	18
marking.....	23	Speed	12, 14, 45, 80
Rotors and accessories		Speed/RCF fine	57
batch number and serial number	23	Speed-gravitational-field-diagram	83
Rotors and accessories with a different service life	24, 86	Speedometer error.....	68
Rotors for microtiter plate formats	35	Spin-out from set speed	54
Rotors with Sigma.....	73	Standard menu	45
Rotors, cleaning and care	72	Standards and regulations	10
Runtime	46	Standstill heating.....	52
		Standstill monitoring system	27

Start delay.....	57	Temperature monitoring system.....	27
Starting a centrifugation run	44	Temperature range	80
Starting a process.....	51	Temperature unit.....	57
Sterilisation of the rotor chamber and accessories	74	Temperature value not reached	66
Stopping of the centrifuge due to an imbalance.....	73	Thermal stress	70
Storage and transport	29	Time fine.....	57
Storage conditions	29	Time range.....	80
Storage locations	80	Toxic substances	21, 70
Stress-corrosion		Transport safety device.....	30
see		Tubes.....	40
corrosion	72	Type.....	12, 80
Structural changes.....	21	Type of connection.....	32
Supply voltage	32	Type of the centrifuge	69, 76
Supporting rings.....	40	U	
Switching the centrifuge off	65	UKCA declaration of conformity	95
Switching the centrifuge on	34	Unblocking a function.....	55
System.....	58	Ungreased load- bearing bolts	66
System check	27	Units of protection class I	32
System error	66, 68	Useful volume	
T		- volume that is stated for the tube	40
Table of error codes.....	68	User interface	43
Table of rotors and accessories with a different service life	24, 86	UV radiation	32, 70
Technical data	80	V	
Technical documentation	81	Vents	32
Temperature	45	Vessels	40
Temperature error.....	68	W	
Temperature inside the rotor chamber	27	Warning signal	58
Temperature monitoring.....	53	Warranty and liability.....	9
		Wear.....	76
		Weight	29