



Sigma 2-16KL

from serial no. 146109



Refrigerated Centrifuge

Operating Manual

Please retain for later use!



© Copyright by
Sigma Laborzentrifugen GmbH
An der Unteren Söse 50
37520 Osterode am Harz
Germany

Tel.: +49 (0) 5522 / 5007-0
Fax: +49 (0) 5522 / 5007-12
Web: www.sigma-zentrifugen.de
E-mail: info@sigma-zentrifugen.de

1	General information	9
1.1	Importance of the operating manual	9
1.2	Intended use	9
1.3	Warranty and liability	9
1.4	Copyright	10
1.5	Standards and regulations	10
1.6	Scope of supply	10
2	Layout and mode of operation	11
2.1	Layout of the centrifuge	11
2.1.1	Functional and operating elements	11
2.1.2	Name plate	12
2.2	Mode of operation	13
2.2.1	Centrifugation principle	13
2.2.2	Area of application	13
2.2.2.1	Speed, radius, and relative centrifugal force	14
2.2.2.2	Density	14
3	Safety	15
3.1	Marking of the unit	15
3.2	Explanation of the symbols and notes	16
3.3	Responsibility of the operator	17
3.4	Requirements concerning the personnel	18
3.5	Informal safety instructions	19
3.6	Safety instructions	20
3.6.1	Electrical safety	20
3.6.2	Mechanical safety	20
3.6.3	Fire prevention	21
3.6.4	Chemical and biological safety	21
3.6.5	Safety instructions for centrifugation	22
3.6.6	Resistance of plastics	22
3.6.7	Safety of rotors and accessories	22
3.6.7.1	Marking of rotors and accessories	22
3.6.7.2	Service life of rotors and accessories	23
3.6.7.3	Service life of the Sigma "Comfort" rotor coating	24
3.7	Safety devices	26
3.7.1	Lid lock device	26
3.7.2	Standstill monitoring system	26
3.7.3	System check	26
3.7.4	Earth conductor check	26
3.7.5	Imbalance monitoring system	26
3.7.6	Temperature monitoring system	26
3.7.7	Rotor monitoring system	26
3.8	Measures in the event of hazards and accidents	27
3.9	Remaining hazards	27

Table of contents

4	Storage and transport	28
4.1	Dimensions and weight.....	28
4.2	Storage conditions	28
4.3	Notes on transport	28
4.4	Packaging.....	29
4.5	Transport safety device.....	29
5	Set-up and connection	30
5.1	Installation site	30
5.2	Power supply	30
5.2.1	Type of connection	30
5.2.2	Customer-provided fuses.....	31
6	Using the centrifuge	32
6.1	Initial start-up	32
6.2	Switching the centrifuge on	32
6.2.1	Opening and closing the lid.....	32
6.2.2	Installation of rotors and accessories	32
6.2.2.1	Installation of a rotor	32
6.2.2.2	Installation of an angle rotor with a hermetic lid.....	33
6.2.2.3	Installation of the microhaematocrit rotor.....	34
6.2.2.4	Installation of accessories	35
6.2.2.5	Adapters	37
6.2.2.6	Vessels	37
6.3	Control system "Spincontrol L"	38
6.3.1	User interface	38
6.3.2	Manual mode.....	39
6.3.2.1	Starting a centrifugation run	39
6.3.2.2	Interrupting a centrifugation run	39
6.3.2.3	Interrupting a deceleration process	39
6.3.2.4	Selection, display, and modification of data.....	39
6.3.2.5	Speed / relative centrifugal force (RCF)	40
6.3.2.6	Runtime	40
6.3.2.7	Temperature	42
6.3.2.8	Rotor selection	44
6.3.2.9	Acceleration and deceleration curves.....	45
6.3.2.10	Automatic lid opening function ("AutoOpen").....	45
6.3.2.11	Sound signal ("Buzzer")	46
6.3.2.12	Program lock ("ProgLock").....	46
6.3.2.13	Cycle display ("Cycles")	47
6.3.2.14	Input lock	48
6.3.3	Program mode.....	48
6.3.3.1	Saving a program.....	49
6.3.3.2	Loading a program.....	49
6.4	Switching the centrifuge off	50

Table of contents

7	Malfunctions and error correction	51
7.1	General malfunctions	51
7.1.1	Emergency lid release	52
7.2	Table of error codes	53
7.3	Service contact	54
8	Maintenance and service	55
8.1	Maintenance	55
8.1.1	Centrifuge	55
8.1.1.1	Condenser (only refrigerated centrifuges with an air-cooled refrigeration system)	56
8.1.2	Accessories	56
8.1.2.1	Plastic accessories	57
8.1.3	Rotors, buckets and carriers	57
8.1.3.1	Load-bearing bolts	57
8.1.4	Microhaematocrit rotor	59
8.1.5	Glass breakage	59
8.2	Sterilisation and disinfection of the rotor chamber and accessories	60
8.2.1	Autoclaving	61
8.3	Service	62
8.4	Return of defective centrifuges or parts	63
9	Disposal	65
9.1	Disposal of the centrifuge	65
9.2	Disposal of the packaging	65
10	Technical data	66
10.1	Ambient conditions	67
10.2	Technical documentation	67
11	Appendix	68
11.1	Range of accessories	68
11.1.1	Rotor radii	68
11.2	Speed-gravitational-field-diagram	69
11.3	Acceleration and deceleration curves	70
11.4	Table of the service life of rotors and accessories	71
11.5	Resistance data	72
11.6	EC declaration of conformity	77
11.7	Declaration of conformity – China RoHS 2	79
11.8	UKCA declaration of conformity	81
12	Index	83

Table of contents

1 General information

1.1 Importance of the operating manual

A fundamental requirement for the safe and trouble-free operation of the centrifuge is to be familiar with the fundamental safety instructions and all possible hazards.

The operating manual includes important information concerning the safe operation of the centrifuge.

This operating manual and, in particular, the notes on safety and hazards must be observed by all persons operating the centrifuge.

In addition, the local rules and regulations for the prevention of accidents must be complied with.

1.2 Intended use

Centrifuges are power-driven machines that separate liquids from solid matter, liquid mixtures, or solid mixtures by centrifugal force. They are solely intended for this purpose. Any other use beyond this area of application is regarded as improper use. Sigma Laborzentrifugen GmbH cannot be held liable for any damage resulting from such improper use.

The intended use also includes

- observation of all the notes and instructions included in the operating manual and
- compliance with the care, cleaning, and maintenance instructions.

1.3 Warranty and liability

The warranty and liability are subject to our "General Conditions" that were distributed to the operator upon the conclusion of the contract.

Warranty and liability claims are excluded if they are due to:

- improper use.
- non-compliance with the safety instructions and hazard warnings in the operating manual.
- improper installation, start-up, operation, or maintenance of the centrifuge.

1 General information

1.4 Copyright

The copyright concerning the operating manual remains with Sigma Laborzentrifugen GmbH.

The operating manual is solely intended for the operator and their personnel. It includes instructions and information that must not be

- duplicated,
- distributed, or
- communicated in any other way.

Non-compliance may be prosecuted under criminal law.

1.5 Standards and regulations

These operating instructions have been created in accordance with the relevant European standards and regulations (see chapter 11.6 - "EC declaration of conformity").

1.6 Scope of supply

The centrifuge comprises:

- 1 power cord with an IEC C13 connector
- 1 rotor wrench Part no. 930 100
- 1 tube (30 g) heavy-duty grease for load-bearing bolts Part no. 71 401

Documentation

Operating manual incl. EC declaration of conformity (see chapter 11.6 - "EC declaration of conformity")

Accessories

According to your order, our order confirmation, and your delivery note.

2 Layout and mode of operation

2.1 Layout of the centrifuge

2.1.1 Functional and operating elements

- 1 Lid
- 2 User interface (see chapter 6.3.1 - "User interface")
- 3 Mains switch



Fig. 1: Total view of the centrifuge

- 4 Name plate (see chapter 2.1.2 - "Name plate")
- 5 Mains power



Fig. 2: Rear view of the centrifuge

2 Layout and mode of operation

2.1.2 Name plate

- 1 Manufacturer
- 2 Power consumption
- 3 Max. speed
- 4 Max. kinetic energy
- 5 Serial number
- 6 Part number
- 7 Type
- 8 Nominal voltage
- 9 CE mark in compliance with the directive 2006/42/EC
- 10 Symbol for special disposal (see chapter 9 - "Disposal")
- 11 Consult operating manual
- 12 Date of manufacture
- 13 Max. permissible density
- 14 Refrigerant data

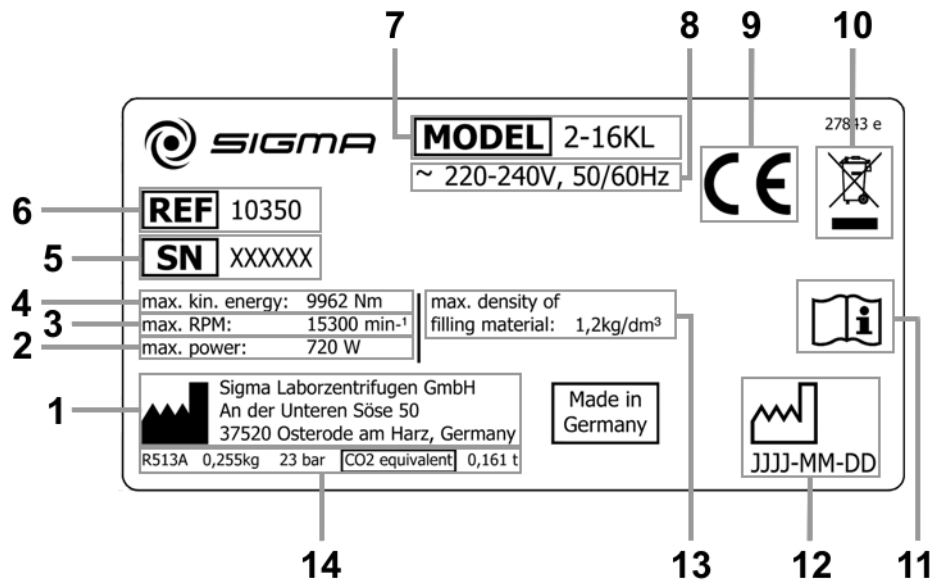

Fig. 3: Example of a name plate

2.2 Mode of operation

2.2.1 Centrifugation principle

Centrifugation is a process for the separation of heterogeneous mixtures of substances (suspensions, emulsions, or gas mixtures) into their components. The mixture of substances, which rotates on a circular path, is subject to centripetal acceleration that is several times greater than the gravitational acceleration.

Centrifuges use the mass inertia inside the rotor chamber for separating the substances. Due to their higher inertia, particles or media with a higher density travel outwards. In doing so, they displace the components with a lower density, which in turn travel towards the centre.

The centripetal acceleration of an object inside a centrifuge, as the effect of centripetal force, depends on the distance between the object and the axis of rotation as well as on the angular velocity. It increases linearly as a function of the distance with regard to the axis of rotation and quadratically as a function of the angular velocity. The bigger the radius in the rotor chamber is and the higher the speed is, the higher the centripetal acceleration is. However, the forces acting on the rotor also increase.

2.2.2 Area of application

Depending on the area of application of the centrifuge and also on the particle size, solids content, and volume throughput of the mixture of substances that is to be centrifuged, there are different types of centrifuges.

The areas of application go from household use as a salad spinner or honey separator up to specialised technical applications in the clinical, biological, or biochemical context:

- For numerous clinical examinations, cellular material must be separated from the liquid to be analysed. The normal separation process can be sped up considerably by using laboratory centrifuges.
- In the metal-working industry, centrifuges are used for separating oil from metal cuttings. Dairies use centrifuges in order to separate cow's milk into cream and low-fat milk.
- Particularly big centrifuges are used in the sugar industry for separating the syrup from the crystalline sugar.
- Ultracentrifuges are predominantly used in biology and biochemistry in order to isolate particles, e.g. viruses. They are specifically designed for high speeds up to 500,000 rpm. The rotor moves in a vacuum in order to avoid air friction.

2 Layout and mode of operation

2.2.2.1 Speed, radius, and relative centrifugal force

The acceleration g , which the samples are subject to, can be increased by increasing the radius in the rotor chamber and by increasing the speed. These three parameters are interdependent and linked with each other via the following formula:

$$\text{Relative centrifugal force RCF} = 11.18 \times 10^{-6} \times r \times n^2$$

r = radius in cm

n = speed in rpm

RCF without any dimension

If two values are entered, the third value is determined by way of the stated formula. If, afterwards, the speed or the radius is changed, the resulting relative centrifugal force will be recalculated automatically by the control unit. If the RCF is changed, the speed will be adapted while the specified radius is maintained.

The speed-gravitational-field-diagram provides an overview of the relationship between speed, radius, and RCF (see chapter 11.2 - "Speed-gravitational-field-diagram").

2.2.2.2 Density

The laboratory centrifuge is suitable for the separation of constituents of different densities in mixtures with a maximum density of 1.2 g/cm^3 . All information concerning the speed of rotors and accessories refers to liquids with a density corresponding to this specification. If the density is above this value, the maximum permissible speed of the centrifuge must be reduced based on the following formula:











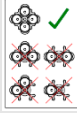

$$n = n_{max} \times \sqrt{(1.2/\rho)}$$

ρ = density in g/cm^3

3 Safety

3.1 Marking of the unit

The following symbols are used on this centrifuge:

 <p>On (Power)</p>	 <p>Arrow indicating the direction of rotation</p>
 <p>Off (Power)</p>	 <p>Rotor loading information (see chapter 6.2.2.4 - "Installation of accessories")</p>
 <p>Name plate (see chapter 2.1.2 - "Name plate")</p>	 <p>CE mark in compliance with the directive 2006/42/EC</p>
 <p>Do not dispose as part of domestic waste</p>	 <p>Consult operating manual</p>
 <p>NRTL mark (only for the USA and Canada)</p>	 <p>RCM mark (only for Australia)</p>
 <p>China RoHS 2 mark (only for China)</p>	 <p>California Proposition 65 mark (only for the USA)</p>
 <p>UKCA mark (only for UK)</p>	

i
NOTE

Safety indications on the centrifuge must be kept readable at all times. If necessary, they must be replaced.

i
NOTE

The marking varies depending on the version and country of destination of the centrifuge.

3 Safety

3.2 Explanation of the symbols and notes

In this operating manual, the following names and symbols to indicate hazards are used:



This symbol stands for a **direct** hazard to the life and health of persons.

Non-observance of these symbols **causes** serious health problems up to life-endangering injuries.



This symbol stands for a **direct** hazard to the life and health of persons due to electrical voltage.

Non-observance of these symbols **causes** serious health problems up to life-endangering injuries.



This symbol stands for a **potential** hazard to the life and health of persons.

Non-observance of these symbols **can** cause serious health problems up to life-endangering injuries.



This symbol indicates a potentially hazardous situation

Non-observance of these notes can cause minor injuries or damage to property.



This symbol indicates important information.

3.3 Responsibility of the operator

The operator is responsible for authorising only qualified personnel to work on the centrifuge (see chapter 3.4 - "Requirements concerning the personnel").

The areas of responsibility of the personnel concerning the operation, maintenance, and care of the unit must be clearly defined.

The safety-conscious work of the personnel in compliance with the operating manual and the relevant EC and national health and safety regulations as well as with the accident prevention regulations must be checked at regular intervals (e.g. every month).

Under the international rules for health and safety at work, the operator is obliged to:

- take measures in order to prevent all danger to life or health during work.
- ensure that centrifuges are operated properly and entirely as intended (see chapter 1.2 - "Intended use").
- take protective measures against fire and explosion when working with hazardous substances.
- take measures for the safe opening of centrifuges.

The operator must perform a risk assessment concerning potential accidents in connection with the centrifuge and take design-related countermeasures, if necessary.

The centrifuge has to be maintained regularly (see chapter 8 - "Maintenance and service").

Components that are not in a perfect state must be replaced immediately.

3 Safety

3.4 Requirements concerning the personnel



DANGER

Risk of injury if the personnel are not sufficiently qualified

If unqualified personnel perform work on the centrifuge or are present in the danger zone of the centrifuge, hazards result that can cause serious injuries and considerable damage to property.

- Ensure that all the tasks are performed by personnel with the corresponding qualifications.
- Ensure that unqualified personnel stay clear of the danger zones.



DANGER

Risk of fatal injury to unauthorised persons due to hazards in the danger zone or work area

Unauthorised persons who do not fulfil the requirements described herein are not aware of the hazards in the work area. This is why there is a risk of serious or even fatal injuries for unauthorised persons.

- Ensure that unauthorised persons stay clear of the danger zone and work area.
- If in doubt, address these persons and instruct them to leave the danger zone and work area.
- Interrupt any running work if unauthorised persons are present in the danger zone or work area.

This manual uses the following personnel qualifications for various areas of activity:

Qualified electrician

Due to their special training, knowledge, experience and familiarity with the relevant standards and regulations, qualified electricians are in the position to perform work on electrical systems and to autonomously identify and prevent possible hazards.

Qualified electricians have been specifically trained for the environment in which they work and they are familiar with all the relevant standards and regulations.

Qualified electricians must fulfil the requirements as set out in the applicable legal provisions concerning the prevention of accidents.

Specialised personnel

Due to their special training, knowledge, experience and familiarity with the relevant regulations, specialised personnel are in the position to perform any tasks assigned to them and to autonomously identify and prevent possible hazards.

Operating personnel

Only trained, specialised personnel are authorised to operate the unit. The persons operating the unit must

- be familiar with the fundamental health, safety, and accident prevention regulations,
- have read and understood this operating manual, in particular the safety sections and warning notes, and confirmed this with their signature,
- have been instructed in the operation and maintenance of this centrifuge.

3.5 Informal safety instructions

- This operating manual is a part of the product.
- The operating manual must be kept at the location of use of the centrifuge. Ensure that it is accessible at all times.
- The operating manual must be handed over to any subsequent owner or operator of the centrifuge.
- Any changes, additions or updates received must be added to the operating manual.
- In addition to the operating manual, the general and local rules and regulations concerning the prevention of accidents and the protection of the environment must also be supplied.
- Safety and danger indications on the centrifuge must be kept readable at all times. If necessary, they must be replaced.

3 Safety

3.6 Safety instructions

3.6.1 Electrical safety

As protection against electric shock, the centrifuge is equipped with an earthed mains power cable and connector. To ensure the effectiveness of this safety feature, the following must be ensured:



DANGER

- Ensure that the wall socket is properly wired and grounded.
- Check that the mains voltage agrees with the nominal voltage listed on the name plate.
- Ensure that the mains power cable is intact prior to using the centrifuge. Damaged or faulty mains power cables must be replaced immediately.
- Do not place vessels containing liquid on the centrifuge lid or within the safety distance of 30 cm around the centrifuge. Spilled liquids may get into the centrifuge and damage electrical or mechanical components.
- Only qualified and specialised personnel are authorised to perform service tasks or repairs of the electrical system for which the housing needs to be removed.
- Inspect the electrical equipment of the unit regularly. Defects such as loose or burnt cables must be eliminated immediately.
- Following the completion of any type of repair or service, the qualified and specialised personnel must perform final inspection and testing in compliance with the relevant standards.

3.6.2 Mechanical safety

In order to ensure the safe operation of the centrifuge, observe the following:



WARNING

- Do not open the lid when the rotor is in motion!
- Do not reach into the rotor chamber when the rotor is in motion!
- Do not use the centrifuge if it was installed incorrectly.
- Do not use the centrifuge without panels.
- Do not use the centrifuge if the rotors and inserts show signs of corrosion or other defects.
- Only use the centrifuge with rotors and accessories that have been approved by the manufacturer. In case of doubt, contact the manufacturer (see chapter 7.3 - "Service contact").
- Do not hold your fingers between the lid and the housing when closing the lid. Risk of crushing!
- Defective lid relieving devices could cause the centrifuge lid to fall (contact the service department, if necessary). Risk of crushing!
- Do not hit or move the centrifuge during its operation.
- Do not lean against or rest on the centrifuge during its operation.

**WARNING**

- Do not spin any substances that could damage the material of the rotors and buckets of the centrifuge in any way. Highly corrosive substances, for example, damage the material and affect the mechanical strength of the rotors and buckets.
- Stop the centrifuge immediately in the event of a malfunction. Eliminate the malfunction (see chapter 7 - "Malfunctions and error correction") or inform the service department of the manufacturer (see chapter 7.3 - "Service contact").
- Ensure that all repairs are performed only by authorised and specialised personnel.
- Prior to any start-up, check the centrifuge, rotor, and accessories for signs of damage that can be discerned from the outside. Special attention must be paid to all of the rubber parts (e.g. motor cover, lid seal, and adapters) in terms of visible structural changes. Defective parts must be replaced immediately.
- Open the centrifuge when it is not in use so that moisture can evaporate.

3.6.3 Fire prevention

**DANGER**

- Do not spin explosive or inflammable substances.
- Do not use the centrifuge within hazardous locations.

3.6.4 Chemical and biological safety

If pathogenic, toxic, or radioactive samples are intended to be used in the centrifuge, it is in the responsibility of the user to ensure that all necessary safety regulations, guidelines, precautions, and practices are adhered to accordingly.

**DANGER**

- Infectious, toxic, pathogenic, and radioactive substances may only be used in special, certified containment systems with a bio-seal in order to prevent the material from being released.
- Take suitable precautions for your own safety if there is a risk of toxic, radioactive, or pathogenic contamination
- Materials that chemically react with each other with a high level of energy are prohibited.

**WARNING**

- Keep informed about local measures to avoid harmful emissions (depending on the substances to be centrifuged).
- Protective clothing is not required for the operation of the centrifuge. The materials to be centrifuged may, however, require special safety measures (e.g. centrifugation of infectious, toxic, radioactive, or pathogenic substances).

3 Safety

3.6.5 Safety instructions for centrifugation

For safe operation, observe the following before starting the centrifuge:



WARNING

- Ensure that the centrifuge was set up properly (see chapter 5 - "Set-up and connection").
- Keep a safety range of at least 30 cm free around the centrifuge as well as with regard to walls and other devices.
- Do not store any dangerous goods in the centrifuge area.
- Do not stay in the safety area longer than what is absolutely necessary for the operation of the centrifuge.
- Only use the centrifuge with rotors and accessories that have been approved by the manufacturer. We explicitly warn against the use of equipment of poor quality. Breaking glass or bursting vessels can cause dangerous imbalances at high speeds.
- Ensure that the rotor and buckets are correctly fitted (see chapter 6.2.2.1 - "Installation of a rotor").
- Observe the instructions on the installation of accessories (see chapter 6.2.2.4 - "Installation of accessories").
- The rotor must be loaded in a rotationally symmetrical manner at equal weights.
- If liquids with a density $> 1.2 \text{ g/cm}^3$ are used, reduce the speed (see chapter 2.2.2.2 - "Density").
- Do not use the centrifuge if the rotor is loaded asymmetrically.
- Do not use the centrifuge with tubes that are excessively long.

3.6.6 Resistance of plastics

Chemical influences have a strong effect on the polymeric chains of plastics, and, therefore, on their physical properties. Plastic parts can be damaged if solvents, acids, or alkaline solutions are used.



NOTE

- Refer to the resistance data (see chapter 11.5 - "Resistance data")!

3.6.7 Safety of rotors and accessories

3.6.7.1 Marking of rotors and accessories

Marking of the service life of rotors and accessories

see chapter 3.6.7.2 - "Service life of rotors and accessories"

Marking of rotors with Sigma "Comfort" rotor coating

see chapter 3.6.7.3 - "Service life of the Sigma "Comfort" rotor coating"

3.6.7.2 Service life of rotors and accessories

The rotors and accessories have a limited service life.



WARNING

- Perform regular checks (at least once per month) for safety reasons!
 - Pay special attention to changes, such as corrosion, cracks, material abrasion, etc.
-
- After 10 years, they must be inspected by the manufacturer.
 - After 50,000 cycles, the rotor must be scrapped for reasons of safety.
 - If other data concerning the service life are engraved on the rotor or bucket, these data shall apply accordingly. For example, a bucket with the engraving "max. cycles = 10,000" has a service life of 10,000 cycles, and a rotor with the engraving "Exp. date 01/27" must be scrapped in January 2027 at the latest (see figure).
 - If a specification concerning the maximum number of cycles **and** a specification concerning the service life (i.e. a date) are provided, the specification that occurs first shall apply.



Fig. 4: Different service life – engraving on the bucket/rotor



NOTE

- Refer to the table of the service life of rotors and accessories (see chapter 11.4 - " Table of the service life of rotors and accessories ")!

3 Safety

3.6.7.3 Service life of the Sigma "Comfort" rotor coating

Marking

II "Comfort" coated swing-out rotors have a "C" shown after their number. The bolts of these rotors do not require any greasing during the service life of the coating.

- 1 Marking indicating the "Comfort" rotor coating
- 2 Load-bearing bolt



Fig. 5: Marking of a rotor with "Comfort" coating (example)



A portfolio of the available rotors with "Comfort" rotor coating and information on the service life of the coating can be found in the document "Sigma Comfort rotor coating", which is provided with every rotor with "Comfort" rotor coating.

Service life

The service life of the coating varies and depends on the degree of utilisation of the rotor. Tests have shown a service life of 7,000 to 40,000 cycles. The service life of the "Comfort" rotor coating can be increased by way of specific measures:

The following factors have an influence on the service life:

- **Speed/load:**
The service life of the coating can be increased by a factor of 3.5 if the speed or load is decreased by approximately 15%. In case of a load decrease by 20%, the service life increases approximately by a factor of 5.5.
- **Temperature:**
The service life of the coating decreases by approximately 30% at lower temperatures (approximately 4°C) compared to room temperature (approximately 20°C).
- **Use of buckets:**
The buckets and the rotor form a joint unit. For the coating to reach the maximum possible service life, ensure to always use the same set of buckets and to install the individual buckets in their specific position within the rotor.
- **Cleaning frequency:**
Regular cleaning of the accessories is indispensable. The more frequently the rotor needs to be cleaned, the shorter the service life of the coating will be.



Traces of use on the black coating do not affect the anti-friction properties (see the following illustration).



Fig. 6: Load-bearing bolt with traces of use – no greasing required

End of the service life of the "Comfort" rotor coating

When the coating has worn off nearly completely and the metallic surface of the load-bearing bolt becomes visible (see the following illustration), the anti-friction effect decreases. As a result, the buckets will swing out irregularly, thereby potentially resulting in unwanted imbalance.

- From this moment on, the rotor must be used with greased load-bearing bolts (heavy-duty grease for load-bearing bolts, ref. no. 71401) until it reaches the end of its service life.
- Mark the rotor accordingly to prevent it from being used without grease on the load-bearing bolts.



Fig. 7: Load-bearing bolt with completely worn-off coating – greasing required

3 Safety

3.7 Safety devices

3.7.1 Lid lock device

The centrifuge can only be started when the lid is properly closed. The electrical lock must be locked. The lid can only be opened when the rotor has stopped. If the lid is opened by way of the emergency release system during operation, the centrifuge will immediately switch off and decelerate brakeless. If the lid is open, the drive is completely separated from the mains power supply, i.e. the centrifuge cannot be started (see chapter 7.1.1 - "Emergency lid release").

3.7.2 Standstill monitoring system

Opening of the centrifuge lid is only possible if the rotor is at a standstill. This standstill is checked by the microprocessor.

3.7.3 System check

An internal system check monitors the data transfer and sensor signals with regard to plausibility. The system continuously performs a self-check and identifies malfunctions. Error messages are displayed as "Error" followed by a code number (see chapter 7.2 - "Table of error codes").

3.7.4 Earth conductor check

An earth conductor check can be carried out by authorised and specialised personnel using a suitable measuring instrument. Please contact the Sigma service department (see chapter 7.3 - "Service contact").

3.7.5 Imbalance monitoring system

The indication "Imbalance" in the rotor field and, in some cases, also a sound signal indicate that the centrifuge is in the impermissible imbalance range. The drive will be switched off in the acceleration phase or during the run.

3.7.6 Temperature monitoring system

If the temperature inside the rotor chamber rises above +50°C, the drive system will be switched off automatically. The centrifuge cannot be restarted until it has cooled.

3.7.7 Rotor monitoring system

When a rotor number and, if applicable, a bucket number are selected, the computer will automatically check whether the entered speed or the entered gravitational field are permissible for the selected rotor.

3.8 Measures in the event of hazards and accidents



DANGER

- If an emergency arises, switch off the centrifuge immediately!
- If in doubt, call the emergency doctor!

3.9 Remaining hazards

The centrifuge was built in accordance with the state of the art and in compliance with the generally recognized safety rules. However, danger to life and limb of the operator, or of third parties, or impairments of the unit or other material assets cannot be completely excluded when the unit is being used.

- Use the unit only for the purpose that it was originally intended for (see chapter 1.2 - "Intended use").
- Use the unit only if it is in a perfect running state.
- Immediately eliminate any problems that can affect safety.

4 Storage and transport

4 Storage and transport

4.1 Dimensions and weight

	Sigma 2-16KL
Height:	310 mm
Height with open lid:	705 mm
Width:	550 mm
Depth:	570 mm
Weight:	60 kg

4.2 Storage conditions

The centrifuge can be stored in its original packaging for up to a year.

- Store the centrifuge only in dry rooms.
- The permissible storage temperature is between -20°C and +60°C.
- If you would like to store it for more than one year, or if you intend to ship it overseas, please contact the manufacturer.

4.3 Notes on transport

- Install the transport safety device (see chapter 4.5 - "Transport safety device")
- Always lift the centrifuge with a lifting device or with a sufficient number of people helping you.
- When lifting the centrifuge, always reach under the centrifuge from the side.



CAUTION

The centrifuge weighs approx. 60 kg!

- For transport use suitable packaging and, if at all possible, the original packaging (see chapter 4.4 - "Packaging").

4.4 Packaging

The centrifuge is packaged in a threepart slip-lid box.

- Take off the lid.
- Remove the box containing the accessories and the packaging material.
- Remove the ring of the slip-lid box.
- Lift the centrifuge upwards with a lifting device or with a sufficient number of people to lift it safely. When lifting the centrifuge, always reach under the centrifuge from the side.



CAUTION

The centrifuge weighs approx. 60 kg!

- Retain the packaging for any possible future transport of the centrifuge.

4.5 Transport safety device

The transport safety device consists of a foamed plastic piece in the rotor chamber.



CAUTION

The transport safety device must be removed prior to start-up!

Removal

- Open the lid by pressing the lid key. If the centrifuge is not connected to the power supply, use the emergency release of the lid (see chapter 7.1.1 - "Emergency lid release").
- Unscrew the rotor tie-down screw.
- Remove the foamed plastic piece from the rotor chamber, by lifting it carefully on one side.
- Retain the transport safety device for the possibility of the return of the centrifuge.

5 Set-up and connection

5 Set-up and connection

5.1 Installation site

Operate the centrifuge only in closed and dry rooms.

All the energy supplied to the centrifuge is converted into heat and emitted to the ambient air.

- Ensure sufficient ventilation.
- Keep a safety range of at least 30 cm free around the centrifuge as well as with regard to walls or other devices so that the vents in the machine remain unobstructed and fully effective.
- Do not subject the centrifuge to thermal stress, e.g. by positioning it near heat generators.
- Avoid direct sunlight (UV radiation).
- The table must be stable and have a solid, even surface.
- Attention: During transport from cold to warmer places, condensational water will collect inside the centrifuge. It is important to allow sufficient time for drying (min. 24 h) before the centrifuge can be used again.

5.2 Power supply

5.2.1 Type of connection



DANGER

The operating voltage on the name plate must correspond to the local supply voltage!



CAUTION

The mains power plug is an isolating device which is why it must be accessible at all times.

Sigma centrifuges are units of protection class I. The centrifuges of this model series have a three-wire power cord with an IEC C13 connector.



NOTE

The removable power cord must not be longer than 3 m!
The power cord must not be replaced with a power cord of inadequate rating!

5 Set-up and connection

The centrifuges are equipped with a mains power switch with an integrated thermal circuit breaker.

- Switch the unit off by actuating the mains power switch.
- If it has tripped, let the circuit breaker cool for approximately 2 minutes.
- Switch the unit on.

The centrifuge is now ready for operation.

5.2.2 Customer-provided fuses

Typically, the centrifuge must be protected with 16 Amp B fuses that are to be provided by the customer.



To ensure safe disconnection in the event of a fault, an AC/DC-sensitive RCD (residual current device) must be integrated in the wiring system of the building.

6 Using the centrifuge

6 Using the centrifuge

6.1 Initial start-up



DANGER

- Before the initial start-up, please ensure that your centrifuge is properly set up and installed (see chapter 5 - "Set-up and connection").

6.2 Switching the centrifuge on

- Press the mains power switch.
The display then illuminates. The centrifuge is ready for operation.

6.2.1 Opening and closing the lid

The lid can be opened if the centrifuge is at a standstill and if the lid key is illuminated.

- Press the lid key in order to open the lid.
The centrifuge cannot be started if the lid is opened.
- To close, press with both hands slightly on the lid until the lock is audibly locked.



WARNING

Do not place your fingers between the lid and the housing when closing the lid. Risk of crushing!

6.2.2 Installation of rotors and accessories

6.2.2.1 Installation of a rotor

- Open the centrifuge lid by pressing the lid key.
- Unscrew the rotor tie-down screw from the motor shaft (counter-clockwise).
- Lower the rotor with its central bore straight down onto the motor shaft.
- Tighten the rotor tie-down screw clockwise with the supplied rotor wrench with 3 Nm. In doing so, hold the rotor at its outer rim.
- Follow the safety instructions and hazard warnings (see chapter 3 - "Safety")!



WARNING

Once a day or after 20 cycles, the rotor tie-down screw must be loosened by some turns, and the rotor must be lifted and fastened again. This ensures a proper connection between the rotor and the motor shaft.

6 Using the centrifuge



CAUTION

When using rotors for microtiter plate formats:
Ensure that the plate holders are inserted together with the plates into the buckets.



NOTE

The lid screw serves for the fastening of the lid onto the rotor only, not for the fastening of the rotor onto the motor shaft.

Removing a rotor

- Loosen the rotor tie-down screw by turning it anti-clockwise and remove the rotor.

6.2.2.2 Installation of an angle rotor with a hermetic lid

- Open the centrifuge lid by pressing the lid key.
- Unscrew the rotor tie-down screw from the motor shaft (counter-clockwise).
- Screw the rotor lid onto the rotor and tighten it by turning it clockwise.
- Lower the rotor with the lid with its central bore straight down onto the motor shaft.
- Insert the rotor tie-down screw into the motor shaft. Tighten the rotor tie-down screw clockwise with the supplied rotor wrench with 3 Nm. In doing so, hold the rotor at its outer rim.
- Follow the safety instructions and hazard warnings (see chapter 3 - "Safety")!



NOTE

The rotor can also be used without a cover.



NOTE

The lid screw serves for the fastening of the lid onto the rotor only, not for the fastening of the rotor onto the motor shaft.

6 Using the centrifuge

Removing a rotor

- Unscrew the rotor tie-down screw (counter-clockwise) and remove the rotor with the lid.
- Open the lid by turning it counter-clockwise and remove the lid.

- 1 Rotor tie down screw
- 2 Lid
- 3 Rotor

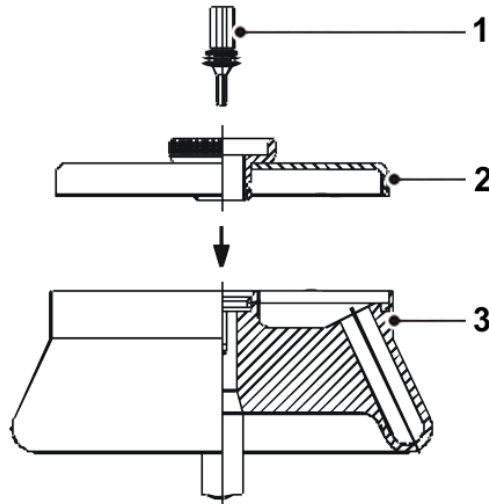

Fig. 8: Angle rotor with a hermetic lid

6.2.2.3 Installation of the microhaematocrit rotor

- Open the centrifuge lid by pressing the lid key.
- Replace the rotor tie-down screw with the rotor tie-down screw of the microhaematocrit rotor (part no. 81543, included in the scope of supply of the microhaematocrit rotor), and tighten it loosely.
- Lower the rotor with its central bore straight down onto the motor shaft.
- Tighten the rotor tie-down screw clockwise with 3 Nm using the supplied rotor wrench. In doing so, hold the microhaematocrit rotor with one hand and tilt it slightly in order to prevent the motor shaft from slipping through.
- Check the rotor for a correct and tight fit.
- Follow the safety instructions and hazard warnings (see chapter 3 - "Safety")!



CAUTION

Please consider the maximum permissible gravitational field of 12,000 x g. An excess gravitational field will result in an increased risk of glass breakage!

6 Using the centrifuge

Operation

- Fill the capillary tubes with blood and seal them at one end with putty or by fusion.
- Place the capillary tubes into the recesses of the rotor with the sealed end against the rubber ring. Ensure that the capillary tubes fit tightly against the rubber ring. The opposite places must be loaded.
- Screw on the rotor cover.
- Close the centrifuge lid.
- Enter the following parameters: RCF 12,000 x g, runtime approx. 5 minutes.
- Start the centrifuge.
- Open the centrifuge lid when the rotor has stopped.
- Unlock the rotor cover and lift it off.

Evaluation

- Put the reader onto the microhaematocrit rotor.
- Turn the reader and perform a fine adjustment with the aid of the central eccentric mechanism in order to localize the O-point and the maximum liquid point in the capillary tubes. You can now read the percentage value.
- Remove the capillary tubes. Some of the tubes can also be evaluated with the reader outside of the rotor (see the instructions for use on the back of the reader).

6.2.2.4 Installation of accessories

- Only use vessels that are suitable for the rotor.
- In the case of swing-out rotors, all of the compartments must be equipped with buckets.
- Always load opposite compartments of the rotors with the same accessories and fill to avoid imbalance.

Centrifugation with vessels of various sizes

Working with vessel of various sizes is possible. In this case, however, it is very important that the rotationally symmetrical inserts are identical.

correct

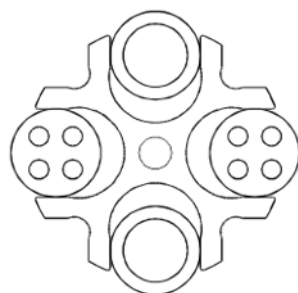

incorrect



Fig. 9: Permissible and impermissible loading of a swing-out rotor with vessels of various sizes (example illustration)

6 Using the centrifuge

Centrifugation with low capacity

- Install the sample vessels in a rotationally symmetrical manner so that the buckets and their suspensions are loaded evenly.
- It is not permissible to load angle rotors on only one axis.

correct

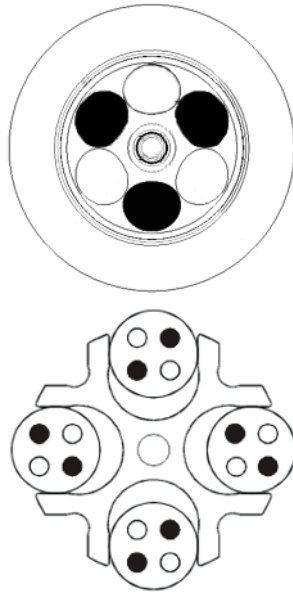

incorrect

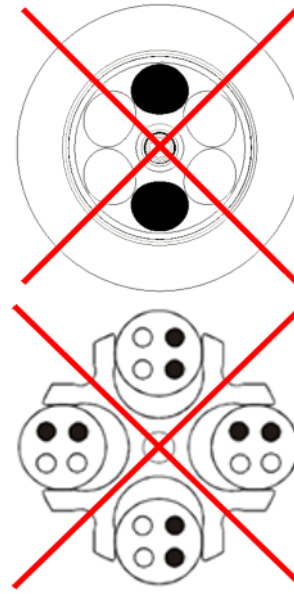

Fig. 10: Permissible and impermissible loading of an angle rotor and a swing-out rotor (example illustrations)

i
NOTE

Pay attention to the marking of the centrifuge (see the illustration below)! Safety indications on the centrifuge must be kept readable at all times. If necessary, they must be replaced.

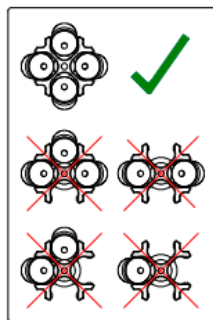

Fig. 11: Safety indication on the centrifuge: Loading of a swing-out rotor

6 Using the centrifuge

6.2.2.5 Adapters

In order to ensure easy handling, even if vessels of various sizes are used, carrier systems were developed.

- Load the opposite adapters with the same number of vessels and with the same weights in order to avoid imbalance.
- If all of the compartments of a carrier are not used, the buckets must be loaded evenly. Loading the edges of a bucket only is not permissible.

6.2.2.6 Vessels

- Load the vessels outside of the centrifuge. Liquids in the buckets or multiple carriers cause corrosion.
- Fill the vessels carefully and arrange them according to their weight. Imbalances result in the excessive wear of the bearings.
- Always fill the tubes up to their useful volume (= the volume that is stated for the tube).
- After the centrifugation, remove the vessels carefully in order to prevent the samples from mixing.
- Follow the safety instructions and hazard warnings (see chapter 3 - "Safety")!

Maximum speed for tubes

Some tubes, such as centrifuge glass tubes, microtubes, culture tubes, fluoropolymer tubes and especially high-volume tubes can be used in our rotors, buckets, and adapters at higher speeds than their breaking limit.



When using glass vessels, the maximum value of 4,000 x g must not be exceeded (except special high-strength glass tubes; please refer to the information provided by the manufacturer).

6 Using the centrifuge

6.3 Control system "Spincontrol L"

6.3.1 User interface

The centrifuge is operated via three buttons with integrated light-emitting diodes and one function knob. The display is divided into several different fields. The various functions of the system can be called up by pressing and turning the function knob.

- 1 Start key
- 2 Function knob
- 3 Display
- 4 Stop key
- 5 Lid key

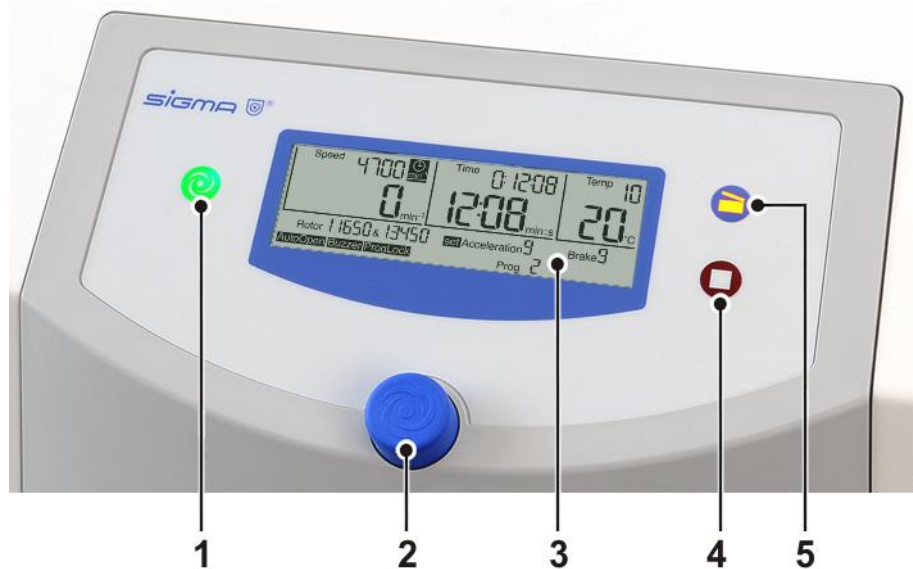

Fig. 12: User interface of the Spincontrol L control system

Display

The centrifuge display has the following display fields:

- 1 Speed/RCF field
- 2 Several display fields (e.g. for rotor, deceleration curve or program selection)
- 3 Time field
- 4 Temperature field

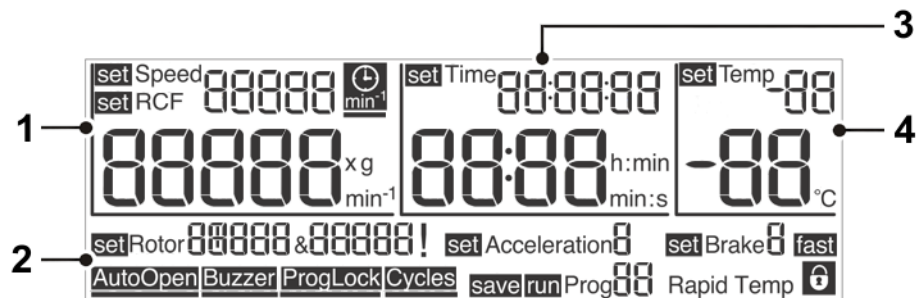

Fig. 13: Display of the Spincontrol L control system

6.3.2 Manual mode

6.3.2.1 Starting a centrifugation run

The centrifuge is ready for operation when the start key is illuminated.

- Press the start key in order to start a centrifugation run.

6.3.2.2 Interrupting a centrifugation run

- Press the stop key in order to interrupt a centrifugation run. The centrifugation run will be terminated prematurely.

Quick stop

- Press the stop key for more than two seconds.

The centrifuge decelerates with the maximum deceleration curve.

After a quick stop, the centrifuge lid must be opened before a new centrifugation run can be started.

A quick stop can also be triggered during a normal deceleration, e.g. in order to speed up the deceleration.

When a quick stop is triggered, "fast" will be displayed in the lower right-hand corner of the display.

6.3.2.3 Interrupting a deceleration process

- Press the start key during a deceleration process in order to interrupt it and to restart the centrifuge.

6.3.2.4 Selection, display, and modification of data

- Turn the function knob in order to select a field. The selected field will be preceded by the indication "set", "run", or "save".
- Press the function knob. The indication ("set", "run", or "save") flashes and the modification mode is active.
- Turn the function knob in order to modify the set value of the selected field.
- Press the function knob again to confirm the input and to quit the modification mode
- The process will be interrupted if the stop key is pressed or after 60 seconds without any further input.

6 Using the centrifuge

6.3.2.5 Speed / relative centrifugal force (RCF)

The set speed of the centrifuge is displayed in the upper area of the Speed/RCF field. The actual value is displayed right below. The speed is stated as the number of revolutions per minute ($\text{min}^{-1} = \text{rpm}$) and the RCF values as a multiple of the gravitational acceleration ($\times g$). The values are interdependent (see chapter 2.2.2.1 - "Speed, radius, and relative centrifugal force"). The maximum speed/RCF values depend on the rotor that is used.

The parameters speed and RCF can be changed during the centrifugation.



Fig. 14: Setting the speed value or the RCF value

6.3.2.6 Runtime

The set runtime is displayed in the upper section of this field, with the remaining runtime shown below. The runtime is counted down from the set value, starting with the start of the centrifuge and ending with the start of the deceleration phase. The maximum runtime is 99 h:59 min:59 sec. As of 59 min:59 sec, the unit switches from "h:min" to "min:s".

The parameter runtime can be changed during the centrifugation.

i NOTE

If the runtime is changed during an active centrifugation run, the time that has already elapsed will not be taken into consideration. The centrifuge will perform a complete run with the new runtime.

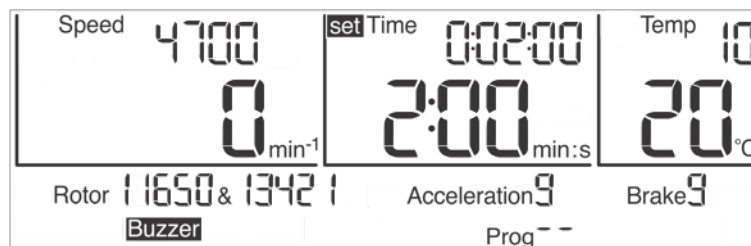

Fig. 15: Setting the runtime, here in the time unit "min:s"

6 Using the centrifuge

Runtime as of the set speed

If the runtime is to be counted as of the moment when the set speed is reached, the symbol (see the illustration) behind the set speed value must be activated:

- Select the clock symbol with the cursor and confirm the selection. The symbol and the bar under the symbol start to flash.
- Activate the function by turning the function knob. The symbol remains displayed in a permanent manner and the bar continues to flash.
- Further turning of the function knob will deactivate the function. In this case, the symbol disappears but the bar continues to flash.
- Press the function knob in order to activate the desired setting. The bar remains visible as long as the cursor is placed on the symbol.



Fig. 16: The function "Runtime as of the set speed" is activated

Continuous run

During the continuous run, the runtime of the centrifuge is unlimited and must be stopped manually. The centrifuge accelerates during the continuous run until the set speed is reached.

- Select the "Time" field and press the function knob. The indication "set" flashes in the activated status.
- Turn the function knob from the time 0:00:10 anti-clockwise or from the time 99:59:59 clockwise. The indication "Cont" will be displayed in the "Time" field. During the centrifugation run, the elapsed time will be displayed.
- Deactivate the continuous run by pressing the stop key or by entering a specific runtime.



Fig. 17: Indication "Cont" during a continuous run

6 Using the centrifuge

Short run

A short run can be started if no run is active.

- Keep the start key pressed during the short run.

During the short run, the centrifuge accelerates with the acceleration curve 9 (maximum) until the maximum permissible speed of the rotor is reached. The runtime is counted and in the "Time" field the indication "Short" is displayed.

When the start key is released, the centrifuge decelerates to a standstill based on the maximum deceleration curve.

When the short run is completed, the original parameters (curves, runtime, and final speed) are restored and displayed.



Fig. 18: Indication "Short" during a short run

6.3.2.7 Temperature

The set value is displayed in the upper area of the field and the actual sample temperature is displayed in the lower area. Temperatures between -10 °C and +40 °C can be preselected.



The centrifuge is not equipped with an active heater. This is why temperatures above room temperature depend on the air friction of the turning rotor.



fig. 19: Setting the temperature

Precooling

Depending on the substances to be centrifuged, it may make sense to precool the centrifuge. The precooling prevents the cooled samples in the uncooled centrifuge from heating up to an inadmissible temperature.



Unmoved air in the rotor chamber distorts the measuring and control behavior and causes the compressor to freeze over. At temperatures below 0 °C, aqueous liquids will freeze, making sedimentation impossible.

- Ensure that the rotor temperature will not fall below 0 °C when the rotor is at a standstill!

6 Using the centrifuge

Program "Rapid Temp"

The centrifuge has a special "Rapid Temp" program that precools the centrifuge rapidly under defined conditions.

- Select the program with the aid of the menu item "run Prog" (see chapter 6.3.3.2 - "Loading a program"). The speed display shows $\frac{1}{3}$ of the maximum rotor speed, the deceleration (brake) and acceleration curves correspond to curve 9 and the runtime field indicates "Cont" (continuous run). "Rapid Temp" will flash next to the "run" display.



Fig. 20: "Rapid Temp" program



The program will only be loaded if the actual temperature is above the set temperature.

- Press the start button in order to start the rapid cooling process.
- During the rapid cooling process, the set temperature can be modified within the range below the actual temperature.

The "Rapid Temp" program will be stopped under the following conditions:

- The set value is reached. The program will stop with a sound signal if this function is activated.
- The stop button is pressed. The program will be stopped prematurely.
- A parameter is changed (except for the temperature and rotors/buckets). In this case, the program will be aborted.

After the stop, the previous program will be reloaded or the changed parameters will be adopted as the new settings.



The automatic lid opening function ("AutoOpen") is suppressed after a rapid cooling phase in order to prevent the system from reheating.



If the "Rapid Temp" program is used, the temperature of the unloaded aluminium bucket will be displayed. If samples, which have not been precooled, are placed into the buckets after a "Rapid Temp" run, the displayed temperature will deviate from the actual sample temperature.

6 Using the centrifuge

6.3.2.8 Rotor selection

This field shows the rotor that is currently being used.



The rotor selection can only be changed when the centrifuge is at a standstill.

- Select the "Rotor" field and confirm the selection. The indication "set" flashes in the activated status.
- Select the desired rotor. If there are rotors with several different types of possible buckets, the various combinations will be displayed one after the other.
- Confirm the input. The selected rotor or rotor/bucket combination will be adopted.



Fig. 21: Preselection of a rotor or a rotor/bucket combination

Automatic rotor identification system

If the centrifuge is equipped with an automatic rotor identification system, the input mode will be activated automatically if the system detects a different rotor with several different types of possible buckets than the rotor that is set. The bucket that is displayed is the bucket with the lowest maximum speed. You can only select different types of buckets for the identified rotor. If the input mode is aborted, this bucket will be stored nonetheless.

This prevents the maximum permissible speed from being exceeded.

6.3.2.9 Acceleration and deceleration curves
Acceleration

This function is used to select an acceleration curve. The system offers 10 fixed, programmed acceleration curves (curves 0-9).

Brake

This function is used in order to select a curve that decelerates the centrifuge to a standstill. Deceleration curves are inverted images of the acceleration curves and are labelled with identical numbers. Deceleration curve no. 0 represents a brakeless deceleration.



Fig. 22: Preselection of a curve; here: preselection of an acceleration curve

6.3.2.10 Automatic lid opening function ("AutoOpen")

The automatic lid opening function must be activated so that the lid opens automatically at the end of the operation.

In order to activate the automatic lid opening function:

- Select the "Auto Open" symbol with the cursor and confirm the selection. The symbol and the bar under the symbol start to flash.
- Activate the function by turning the function knob. The symbol remains displayed in a permanent manner and the bar continues to flash.
- Turning the function knob further will deactivate the function. In this case, the symbol disappears but the bar continues to flash.
- Press the function knob in order to activate the desired setting. The bar remains visible as long as the cursor is placed over the symbol.



Fig. 23: The automatic lid opening function "Auto Open" is activated

6 Using the centrifuge

6.3.2.11 Sound signal ("Buzzer")

This function is used to set an acoustic warning signal that sounds at the end of the centrifugation run and also in the event of an imbalance or error message.

In order to activate the sound signal:

- Select the "Buzzer" symbol with the cursor and confirm the selection. The symbol and the bar under the symbol start to flash.
- Activate the function by turning the function knob. The symbol remains displayed in a permanent manner and the bar continues to flash.
- Turning the function knob further will deactivate the function. In this case, the symbol disappears but the bar continues to flash.
- Press the function knob in order to activate the desired setting. The bar remains visible as long as the cursor is placed over the symbol.



Fig. 24: The sound signal "Buzzer" is activated

6.3.2.12 Program lock ("ProgLock")

When the program lock is active, it is impossible to save any new programs. In this case, the function "save program" is disabled.

In order to activate the program lock:

- Select the "ProgLock" symbol with the cursor and confirm the selection. The symbol and the bar under the symbol start to flash.
- Activate the function by turning the function knob. The symbol remains displayed in a permanent manner and the bar continues to flash.
- Turning the function knob further will deactivate the function. In this case, the symbol disappears but the bar continues to flash.
- Press the function knob in order to activate the desired setting. The bar remains visible as long as the cursor is placed over the symbol.



Fig. 25: The program lock "ProgLock" is activated

6.3.2.13 Cycle display ("Cycles")

In order to activate the cycle display:

- Select the "Cycles" symbol with the cursor and confirm the selection. The symbol is displayed and "set" flashes in front of the rotor display.
- All of the rotors and buckets can be selected by turning the function knob. The cycles of the selected rotor and, if applicable, also of the selected bucket are displayed.
- Press the function knob in order to quit the cycle display.

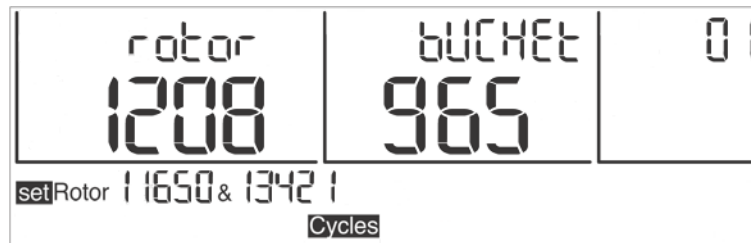

Fig. 26: Cycle display for rotor 11650 and bucket 13421

Reaching the maximum number of cycles

When the maximum number of cycles is reached for a rotor or bucket, a corresponding warning signal will be displayed every time that the centrifuge is started: the start key, lid key, and entire display will flash.

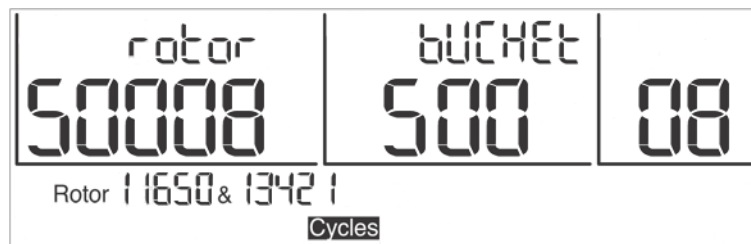

Fig. 27: Display when the maximum number of cycles is reached (flashing)

When the start key is pressed, "CYCLES" will be displayed. The centrifuge will not be started and the display will not return to its normal state until the start key is pressed again.



WARNING

When the maximum number of cycles of the rotor or bucket is reached, the parts must be replaced immediately for safety reasons.

The cycle display will be reset after the rotor and buckets have been replaced by the service department of Sigma Laborzentrifugen GmbH (see chapter 7.3 - "Service contact").

6 Using the centrifuge

6.3.2.14 Input lock

In order to prevent the centrifuge from being manipulated by unauthorised persons, inputs can be disabled via the menu. Inputs via the keypad, i.e. for starting or stopping a centrifugation run or for opening the lid, are enabled.

Activating a simple input lock:

- Position the cursor over the symbol "🔒" in the lower right-hand corner of the display.

As long as the symbol is displayed, the parameters of the centrifuge cannot be changed.

Activating a permanent input lock:

- Press the start key three times and hold for approximately 2 seconds when pressing it for the third time.

After the activation of this function, the padlock symbol flashes. The input lock is activated.

- Proceed in the same manner in order to deactivate the permanent input lock.



Fig. 28: "Padlock" symbol indicating an activated input lock

6.3.3 Program mode

A program contains all the data that are required for a centrifuge run. Certain sedimentation results can be repeated under identical conditions. Programs can be saved, loaded, executed, and edited when the centrifuge is at a standstill.

A maximum of 50 programs can be stored under the numbers 1 - 50. The rapid cooling program "Rapid Temp" does not occupy any storage location and cannot be deleted. It is used to cool the centrifuge without any vessels. "--" means that the values that are currently set are not a stored program.

The programs can be protected against unauthorised use, modification, or deletion with the aid of an input lock (see chapter 6.3.2.14 - "Input lock").

6 Using the centrifuge

6.3.3.1 Saving a program



This function is only available if the centrifuge is at a standstill.

- Enter the parameters that are to be included in the program.
- Select the menu item "save Prog" and confirm the selection. The indication "save" flashes in the activated status.
- Select a random storage location from the program selection list. Free storage locations are indicated by a flashing display. Any storage locations that are already occupied will be overwritten during the saving process.
- Save the program in the desired location.

The program is now saved.



The functions "Auto Open", "Buzzer", "ProgLock", and "Cycles" cannot be entered as part of a program.



Fig. 29: Saving a program

6.3.3.2 Loading a program

- Select the menu item "run Prog" and confirm the selection. The indication "run" flashes in the activated status.
- Select the desired program and confirm the selection by pressing the function knob.

The program is now loaded.



Fig. 30: Loading a program

6 Using the centrifuge

6.4 Switching the centrifuge off

- Open the centrifuge when it is not in use so moisture can evaporate.
- Switch the centrifuge off by pressing the mains power switch.

7 Malfunctions and error correction

7.1 General malfunctions

Error messages are displayed as "Error" followed by a code number. If the acoustic signal is activated, it sounds when the error message is displayed.

- Eliminate the source of the problem (see table below).
- Acknowledge the error messages by pressing the lid key.



NOTE

Error messages can be eliminated by pressing the lid key. The error itself will not be eliminated, but the centrifuge can be operated again.

Type of error	Possible reason	Correction
No indication on the display	No power in the mains supply	Check fuse in the mains supply
	Power cord is not plugged in	Plug in power cord correctly
	Fuses have tripped	Reactivate temperature fuse (see chapter 5.2.1 - "Type of connection")
	Mains power switch off	Switch mains power switch on
Centrifuge cannot be started: start key LED is not illuminated	Several possible causes	Power off/on. If the error occurs again, contact service
Centrifuge cannot be started: lid key LED flashes	The lid lock is not closed correctly	Open and close the lid. If the error occurs again, contact service
Centrifuge decelerates during operation	Brief mains power failure	Press start key in order to restart the centrifuge
	System error	Power off/on. If the error occurs again, contact service
Centrifuge decelerates during operation, imbalance message is displayed	<ul style="list-style-type: none"> – Improper loading – Centrifuge is inclined – Drive problem – Centrifuge was moved during run 	Balance load and restart the centrifuge. If the error occurs again, contact service (see chapter 7.1.1 - "Emergency lid release")
	– Ungreased load-bearing bolts	Clean and grease load-bearing bolts
Lid cannot be opened	Lid lock has not released	Unlock the lid manually and contact service
	Lid seal sticks	Clean the lid seal and apply talcum powder
Temperature value cannot be reached (only for refrigerated centrifuges)	Condenser dirty (only air-cooled units)	Clean the condenser. If the error occurs again, contact service

7 Malfunctions and error correction

7.1.1 Emergency lid release

In the event of a power failure, it is possible to manually open the centrifuge lid.

- Switch off the mains power switch and disconnect the power cord from the socket.
- Remove the plug (see figure, item 1) from the opening at the side panel, e.g. with a screwdriver.



Fig. 31: Position of the opening for the emergency lid release

- The plug is connected with a string. Pull the string in order to release the lid.
- Then, reinsert the stopper into the opening.



WARNING

Do not unlock or open the lid unless the rotor is at a standstill.

If the lid is opened via the emergency lid release system during a centrifuge run, the centrifuge will be switched off immediately and decelerate in an unbraked manner.

7 Malfunctions and error correction

7.2 Table of error codes

Error no.	Kind of error	Measures	Note
1-9	System error	<ul style="list-style-type: none"> Allow to slow down Power off/on 	All these errors stop the centrifuge or cause it to decelerate brakeless
10-19	Speedometer error	<ul style="list-style-type: none"> Allow to slow down Power off/on 	
20-29	Motor error	<ul style="list-style-type: none"> Power off Ensure ventilation 	
30-39	EEPROM error	<ul style="list-style-type: none"> Allow to slow down Power off/on 	With error 34, 35, and 36, the centrifuge will stop; with error 37 and 38 only an error message will be given
40-45	Temperature error (only for refrigerated centrifuges)	<ul style="list-style-type: none"> Allow to slow down Power off Allow to cool down Provide better ventilation (only air-cooled centrifuges) Provide sufficient water throughput (only water-cooled centrifuges) 	
46-49	Imbalance error (only for centrifuges with imbalance monitoring system)	<ul style="list-style-type: none"> Allow to slow down Power off Eliminate the imbalance 	
50-59	Lid error	<ul style="list-style-type: none"> Press lid key Close lid Remove foreign matter from the opening of the lid lock device 	With error 50 and 51, the centrifuge will stop
60-69	Process error	<ul style="list-style-type: none"> Allow to slow down Power off/on 	With error 60, the message "power failure during run" will be displayed, with error 61, the message "stop after power on" will be displayed
70-79	Communication error	<ul style="list-style-type: none"> Allow to slow down Power off/on 	
80-89	Parameter error	<ul style="list-style-type: none"> Power off Allow to cool down Provide for better ventilation 	With error 83, error message only
90-99	Other errors	<ul style="list-style-type: none"> Check connections Provide sufficient water throughput (only water-cooled centrifuges) 	



If it is impossible to eliminate the errors, contact the service!

7 Malfunctions and error correction

7.3 Service contact

In the event of queries, malfunctions, or spare part enquiries:

From Germany:

Contact

Sigma Laborzentrifugen GmbH
An der Unteren Söse 50
37520 Osterode (Germany)
Tel. +49 (0) 55 22 / 50 07-44 44
E-mail: support.lab@sigma-zentrifugen.de

Outside Germany:

Contact our agency in your country. All agencies are listed at
www.sigma-zentrifugen.de → [Sales Partners]



NOTE

- If you would like to utilise our service, please state the type of your centrifuge and its serial number.

8 Maintenance and service

The centrifuge, rotor, and accessories are subject to high mechanical stress. Thorough maintenance performed by the user extends the service life and prevents premature failure.



CAUTION

If corrosion or other damage occurs due to improper care, the manufacturer cannot be held liable or subject to any warranty claims.

- Use soap water or other water-soluble, mild cleaning agents with a pH value between 6 and 8 for cleaning the centrifuge and accessories (see also chapter 8.2 - "Sterilisation and disinfection of the rotor chamber and accessories").
- Avoid corrosive and aggressive substances.
- Do not use solvents.
- Do not use agents with abrasive particles.
- Do not expose the centrifuge and rotors to intensive UV radiation or thermal stress (e.g. by heat generators).

8.1 Maintenance

8.1.1 Centrifuge

- Unplug the mains power plug before cleaning.
- Carefully remove all liquids, including water and particularly all the solvents, acids, and alkaline solutions from the rotor chamber using a cloth in order to avoid damage to the motor bearings.
- If the centrifuge has been contaminated with toxic, radioactive, or pathogenic substances, clean the rotor chamber immediately with a suitable decontamination agent (depending on the type of contamination).



WARNING

Take suitable precautions for your own safety if there is a risk of toxic, radioactive, or pathogenic contamination.

- After every cleaning process, grease the motor shaft slightly with a small amount of heavy-duty grease for load-bearing bolts (part no. 71401) and distribute the grease with a cloth so that it forms a thin layer.

8 Maintenance and service

8.1.1.1 Condenser (only refrigerated centrifuges with an air-cooled refrigeration system)

In order to cool the refrigerant that is compressed by the refrigeration unit, centrifuges with an air-cooled refrigeration system use a lamellar condenser. It is cooled by air.

Dust and dirt obstruct the cooling flow of air. The dust on condenser pipes and lamellas reduces the heat exchange and thus the performance of the refrigeration unit.

This is why the installation site should be as clean as possible.

- Check the condenser at least once a month for dirt and clean it if necessary.
- If you have any queries, please contact service (see chapter 7.3 - "Service contact").

8.1.2 Accessories



CAUTION

For the care of the accessories, special safety measures must be considered as these are measures that will ensure operational safety at the same time!

- Immediately rinse off the rotor, buckets, or accessories under running water if they have come into contact with any liquids that may cause corrosion. Use a brush for test tubes in order to clean the bores of angle rotors. Turn the rotor upside down and allow it to dry completely.
- Clean the accessories outside the centrifuge once a week or preferably after each use. Adapters should be removed, cleaned and dried.



CAUTION

Do not clean the accessories in a dishwasher!

Cleaning in a dishwasher removes the anodised coating; the result is cracking in areas that are subject to stress.

- If the rotors or accessories have been contaminated with toxic, radioactive, or pathogenic substances, clean them immediately with a suitable decontamination agent (depending on the type of contamination). Take suitable precautions for your own safety if there is a risk of toxic, radioactive, or pathogenic contamination.
- Dry the accessories with a soft cloth or in a drying chamber at approx. 50°C.

8.1.2.1 Plastic accessories

The chemical resistance of plastic decreases with rising temperatures (see chapter 11.5 - "Resistance data").

- If solvents, acids, or alkaline solutions have been used, clean the plastic accessories thoroughly.

**WARNING**

Plastic accessories must not be greased!

8.1.3 Rotors, buckets and carriers

Rotors, buckets and carriers are produced with the highest precision, in order to withstand the permanent high stress from high gravitational fields. Chemical reactions as well as stress-corrosion (combination of oscillating pressure and chemical reaction) can affect or destroy the metals. Barely detectable cracks on the surface can expand and weaken the material without any visible signs.

- Check the material regularly (at least once a month) for
 - cracks
 - visible damage of the surface
 - pressure marks
 - signs of corrosion
 - other changes.
- Check the bores of the rotors and multiple carriers.
- Replace any damaged components immediately for your own safety.
- After every cleaning process, grease the rotor tie-down screw slightly with a small amount of heavy-duty grease for load-bearing bolts (part no. 71401) and distribute the grease with a cloth so that it forms a thin layer.

8.1.3.1 Load-bearing bolts**Use of plastic buckets****NOTE**

The load-bearing bolts of the rotor must not be greased if plastic buckets are used!

8 Maintenance and service

Use of aluminium buckets

Rotors with Sigma "Comfort" rotor coating



The load-bearing bolts of some of the swing-out rotors offered by Sigma Laborzentrifugen GmbH have an anti-friction coating. This coating prevents friction between the buckets and bolts.

The bolts do not require any greasing during the service life of the coating (see chapter 3.6.7.3 - "Service life of the Sigma "Comfort" rotor coating")!

All "Comfort" coated swing-out rotors have a "C" shown after their number (see chapter 3.6.7.1 - "Marking of rotors and accessories").



A portfolio of the available rotors with "Comfort" rotor coating and information on the service life of the coating can be found in the document "Sigma Comfort rotor coating", which is provided with every rotor with "Comfort" rotor coating.

Rotors without Sigma "Comfort" rotor coating

For rotors that do not have or no longer have an anti-friction coating, the load-bearing bolts must be greased. Only greased load-bearing bolts ensure a uniform swing-out of the buckets and, therefore, the smooth operation of the centrifuge. Load-bearing bolts that are insufficiently greased may cause the centrifuge to stop due to an imbalance.

- Clean the load-bearing bolts and bucket groove in order to remove the old grease.
- Apply a small amount of heavy-duty grease for load-bearing bolts (ref. no. 71401, see the following picture) to both load-bearing bolts of a bucket.



Fig. 32: Sufficient quantity of grease for one bolt

- Install the bucket and swing it manually back and forth once in order to distribute the grease.
- Repeat this process with all the other buckets.

8.1.4 Microhaematocrit rotor

- Remove the microhaematocrit rotor for cleaning.
- Wipe the centrifuge chamber clean.
- Replace the rubber ring in the event of wear or glass breakage (part no. 16001 for rotor 11409).

8.1.5 Glass breakage**CAUTION**

In the case of glass breakage, immediately remove all glass particles (e.g. with a vacuum cleaner). Replace the rubber cushions since even thorough cleaning will not remove all glass particles.

Glass particles will damage the surface coating (e.g. anodising) of the buckets, which will then lead to corrosion.

Glass particles in the rubber cushions of the buckets will cause glass breakage again.

Glass particles on the pivot bearing of the load-bearing bolts prevent the buckets and carriers from swinging evenly, which will cause an imbalance.

Glass particles in the rotor chamber will cause metal abrasion due to the strong air circulation. This metal dust will not only pollute the rotor chamber, rotor, and materials to be centrifuged but also damage the surfaces of the accessories, rotors, and rotor chamber.

In order to completely remove the glass particles and metal dust from the rotor chamber:

- Grease the upper third of the rotor chamber with e.g. Vaseline.
- Then, let the rotor rotate for a few minutes at a moderate speed (approx. 2000 rpm). The glass and metal particles will now collect at the greased part.
- Remove the grease with the glass and metal particles with a cloth.
- If necessary, repeat this procedure.

8 Maintenance and service

8.2 Sterilisation and disinfection of the rotor chamber and accessories

- Use commercially-available disinfectants such as, for example, Sagrotan[®], Buraton[®], or Terralin[®] (available at chemist's shops or drugstores).
- The centrifuge and the accessories consist of various materials. A possible incompatibility must be considered.
- Before using cleaning or decontamination agents that were not recommended by us, contact the manufacturer to ensure that such a procedure will not damage the centrifuge.
- For autoclaving, consider the continuous heat resistance of the individual materials (see chapter 8.2.1 - "Autoclaving").

Please contact us if you have any queries (see chapter 7.3 - "Service contact").



DANGER

If dangerous materials (e.g. infectious and pathogenic substances) are used, the centrifuge and accessories must be disinfected.

8.2.1 Autoclaving

The service life of the accessories essentially depends on the frequency of autoclaving and use.

- Replace the accessories immediately when the parts show changes in colour or structure or in the occurrence of leaks etc.
- During autoclaving, the caps of the tubes must not be screwed on in order to avoid the deformation of the tubes.



NOTE

It cannot be excluded that plastic parts, e.g. lids or carriers, may deform during autoclaving.

Category	Type of accessory	Material abbreviation	121 °C 20 min	134 °C 20 min	Remarks
Rotors and lids	Aluminium rotors	AL	yes	yes	
	Polypropylen rotors	PP	no	no	
	Polycarbonate lids for angle rotors	PC	no	no	
	Polyallomer lids for angle rotors	PA	no	no	
	Polysulfone lids for angle rotors	PSU	yes	yes	100 cycles max.
Buckets and caps	Aluminium buckets	AL	yes	yes	
	Polyamide buckets	PA	no	no	13035, 13296, 13299
	Polyphenylsulfone caps	PPSU	yes	yes	100 cycles max.
	Polysulfone caps	PSU	yes	yes	100 cycles max.
Adapters	Polyallomer carriers	PA	no	no	
	Polycarbonate carriers	PC	no	no	
	Polypropylene carriers	PP	no	no	
Tubes	Stainless steel tubes and bottles	--	yes	no	
	Glass tubes	--	yes	yes	
	Polyethylene tubes	PE	no	no	
	Polyflor tubes	PF	yes	yes	100 cycles max.
	Polycarbonate tubes	PC	no	no	
	Polypropylene copolymer tubes	PPCO	yes	no	20 cycles max.
	Polystyrene tubes	PS	no	no	
Additional equipment	Stainless-steel balance weight for blood-bag systems	--	yes	no	

8 Maintenance and service

8.3 Service



DANGER

In the event of service work that requires the removal of the panels, there is a risk of electric shock or mechanical injury.

- Only qualified specialist personnel is authorised to perform this service work.
- Following the completion of any type of service, the qualified and specialised personnel must perform final inspection and testing in compliance with the relevant standards.

The centrifuge is subject to high mechanical stress. In order to be able to withstand this high level of stress, high-quality components were used during the production of the centrifuge. Nevertheless, wear cannot be excluded and it may not be visible from the outside. Especially the rubber parts that are – among other things – part of the motor suspension, are subject to ageing.

This is why we recommend having the centrifuge checked by the manufacturer during an inspection once per year in the operating state and once every three years in the dismantled state. Motor damping elements must be replaced after three years.

Information and appointments:

In Germany:

Contact

Sigma Laborzentrifugen GmbH

An der Unteren Söse 50

37520 Osterode (Germany)

Tel. +49 (0) 55 22 / 50 07-44 44

E-mail: support.lab@sigma-zentrifugen.de

Outside Germany:

Contact our agency in your country. All agencies are listed at www.sigma-zentrifugen.de → [Sales Partners]



NOTE

- If you would like to utilise our service, please state the type of your centrifuge and its serial number.

8.4 Return of defective centrifuges or parts

Although we exercise great care during the production of our products, it may be necessary to return a unit or accessory to the manufacturer.

In order to ensure the quick and economical processing of returns of centrifuges, spare parts, or accessories, we require complete and extensive information concerning the process. Please fill in the following forms completely, sign them, enclose them with the return package, and send them together with the product to:

Sigma Laborzentrifugen GmbH
An der Unteren Söse 50
37520 Osterode (Germany)

1. Declaration of decontamination

As a certified company and due to the legal regulations for the protection of our employees and of the environment, we are obliged to certify the harmlessness of all incoming goods. For this purpose, we require a declaration of decontamination.

- The form must be filled in completely and signed by authorised and specialised personnel only.
- Affix the original form in a clearly visible manner to the outside of the packaging.



NOTE

We will return the part/unit if no declaration of decontamination is provided!

2. Form for the return of defective parts

This form is for the product-related data. They facilitate the assignment, and they enable the quick processing of the return. If several parts are returned together in one packaging, please enclose a separate problem description for every defective part.

- A detailed problem description is necessary in order to perform the repair quickly and economically.



NOTE

If the form does not include a description of the malfunction, neither a refund nor a credit note can be issued. In this case, we reserve the right to return the part/unit to you at your expense.

- Upon request, we will prepare and submit to you a cost estimate prior to performing the repair. Please confirm such cost estimate within 14 days. If the cost estimate has still not been confirmed after 4 weeks, we will return the defective part/unit. Please note that you must bear the incurred costs.

8 Maintenance and service



The defective part/unit must be packaged in a transport-safe manner. Please use the original packaging for the unit, if at all possible. If the product is dispatched to us in unsuitable packaging, you will be charged the cost for returning it to you in new packaging.

The forms can be downloaded online from
www.sigma-zentrifugen.de → [Service] → [Overhaul and repair].

9 Disposal

9.1 Disposal of the centrifuge



In accordance with the directive 2012/19/EU, SIGMA centrifuges are marked with the symbol shown to the left. This symbol means that it is not permissible to dispose of the unit among household waste.

- You can return these centrifuges free of cost to Sigma Laborzentrifugen GmbH.
- Ensure that the unit is decontaminated. Fill in a declaration of decontamination (see chapter 8.4 - "Return of defective centrifuges or parts").
- Comply with any other applicable local rules and regulations.

9.2 Disposal of the packaging

- Use the packaging to return the centrifuge for disposal or
- dispose of the packaging, after having separated the individual materials.
- Comply with all local rules and regulations.

10 Technical data

10 Technical data

Manufacturer	Sigma Laborzentrifugen GmbH An der Unteren Söse 50 37520 Osterode (Germany)
Type:	2-16KL
<u>Connection requirements</u>	
Electr. connection:	see name plate
Protection class:	I
IP code:	20
Power consumption (kW):	0.72
Input fuse (AT):	6.0 (at 220-240 V / 50/60 Hz) temperature fuses
<u>Performance data</u>	
Max. speed (rpm):	15,300
Max. capacity (ml):	400
Max. gravitational field (x g):	21,913
Max. kinetic energy (Nm):	9,962
<u>Other parameters</u>	
Time range:	10 sec – 99 h 59 min, short run, continuous run
Temperature range:	-10°C to +40°C
Storage locations:	50
<u>Physical data</u>	
Height (mm):	310
Height with open lid (mm):	705
Width (mm):	550
Depth (mm):	570
Weight (kg):	60
Noise level (dB(A)):	65 (at maximum speed)
<u>Refrigerant data</u>	
Refrigerant:	R513A
Global warming potential (GWP):	631
Filling quantity (kg):	0.255
Max. permissible pressure (bar):	23
CO ₂ equivalent (t):	0.161

10.1 Ambient conditions

- The figures are valid for an ambient temperature of +23°C and a nominal voltage $\pm 10\%$. The minimum temperature is $\leq +4^\circ\text{C}$ and depends on the rotor type, speed, and ambient temperature.



At a nominal voltage of 100V or 200V, a tolerance of +10% / -5% applies.

- For indoor use only.
- Allowable ambient temperature +5°C to +35°C.
- Max. allowable relative humidity of air 80% from 5°C up to 31°C with a linear decrease to 67% relative humidity of air at 35°C.
- Maximum altitude 2,000 m above sea level.

10.2 Technical documentation

For environmental reasons, the comprehensive technical documentation of the centrifuge (e.g. circuit diagrams) and the safety data sheets of the manufacturers of refrigerants and lubricants are not attached to this documentation.

You can order these documents from our service department.

11 Appendix

11 Appendix

11.1 Range of accessories

The complete list of accessories can be downloaded from www.sigma-zentrifugen.de.

11.1.1 Rotor radii

The information in the accessories table concerning the radius refers to the values of the respective rotor as shown below. The radius calculation is described in chapter 2.2.2.1 - "Speed, radius, and relative centrifugal force".

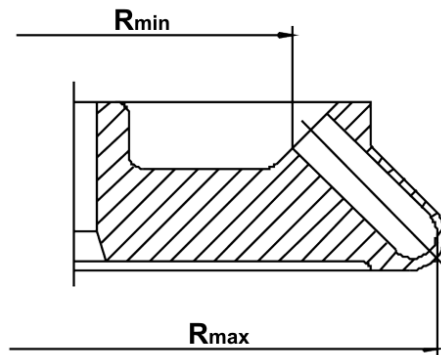

Fig. 33: Minimum and maximum radius of an angle rotor

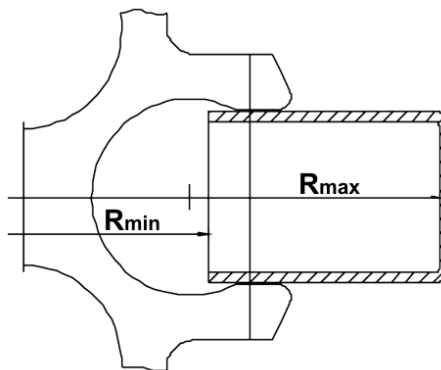

Fig. 34: Minimum and maximum radius of an swing-out rotor

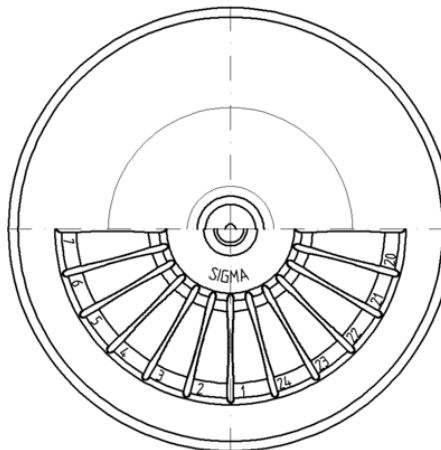

Fig. 35: Microhaematocrit rotor

11.2 Speed-gravitational-field-diagram

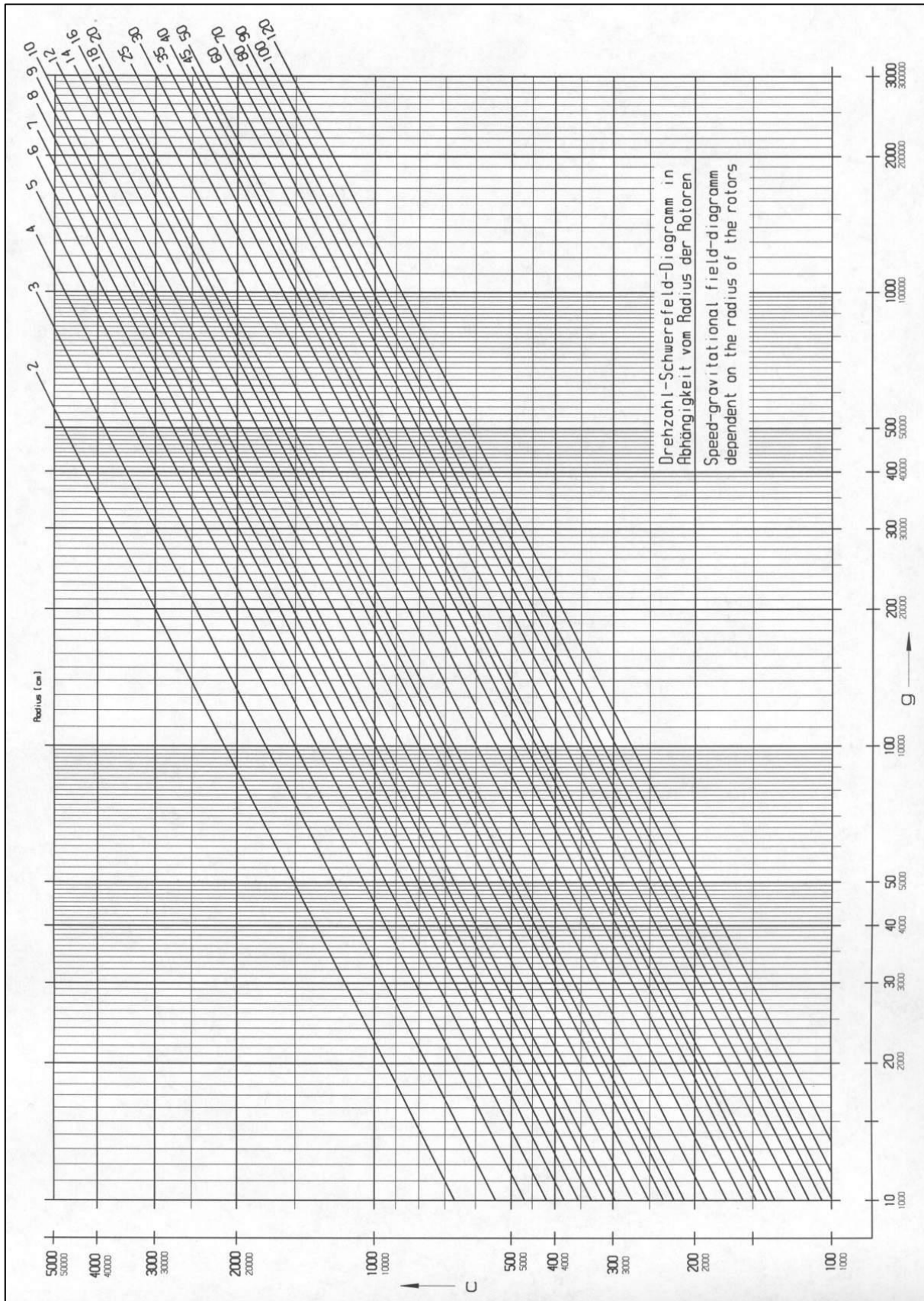

Fig. 36: Speed-gravitational-field-diagram

11 Appendix

11.3 Acceleration and deceleration curves

Linear curves are numbered in the direction of increasing acceleration (from right to left).

The deceleration curves are inverted images of the acceleration curves and are assigned the same numbers. An exception is curve 0. It decelerates brakeless (spin-out).

In general, the runtime, until the set speed is reached, depends on the moment of inertia of the rotor.

Linear curves

The slope of the fixed acceleration curves defines the time that is required to accelerate the rotor by 1,000 rpm.

Curve 9 is a special case compared to the other curves. The centrifuge accelerates with maximum power. The runtime, until the set speed is reached, depends solely on the moment of inertia of the rotor.

Linear curve no.	Slope
0	4 [rpm/sec]
1	6 [rpm/sec]
2	8 [rpm/sec]
3	17 [rpm/sec]
4	25 [rpm/sec]
5	33 [rpm/sec]
6	50 [rpm/sec]
7	100 [rpm/sec]
8	200 [rpm/sec]
9	1.000 [rpm/sec]

Fig. 37: Slope of linear curves

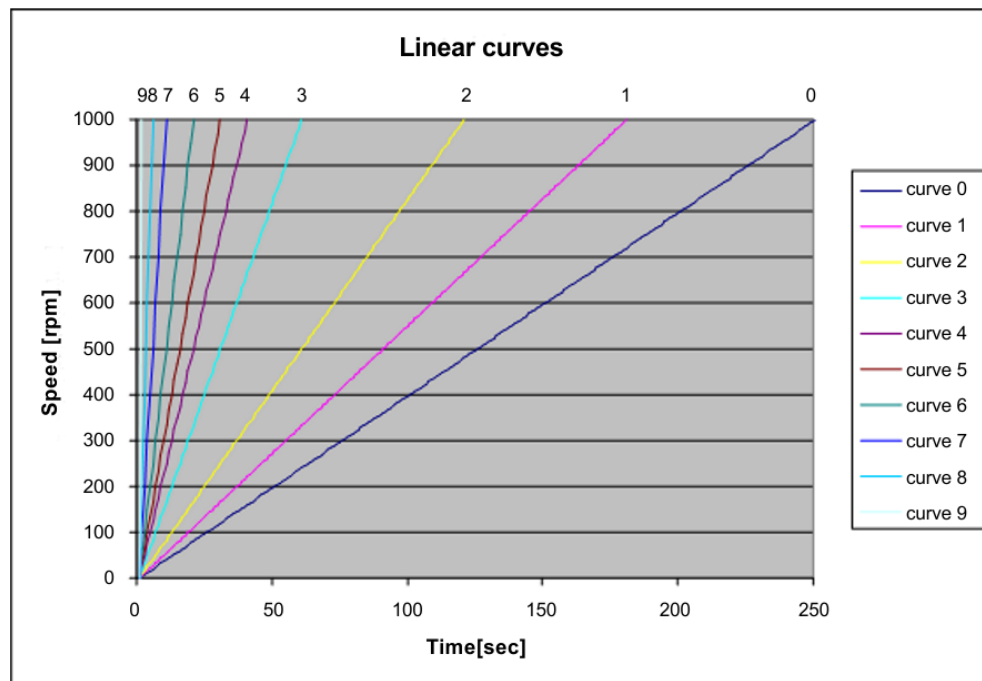

Fig. 38: Diagram of linear curves

11.4 Table of the service life of rotors and accessories

- If no other data concerning the service life are engraved on the rotor or accessory, rotors and buckets must be checked by the manufacturer after 10 years.
- If a specification concerning the maximum number of cycles **and** a specification concerning the service life (i.e. a date) are provided, the specification that occurs first shall apply.
- After 50,000 cycles, rotors must be scrapped for safety reasons.

Rotor / bucket	Cycles	Service life ("Exp.Date")	Suitable for centrifuge	Remarks
9100	35,000		4-16S, 4-16KS, 4-16KHS, 6-16S, 6-16HS, 6-16KS, 6-16KHS	
9366	15,000		4-5KL, 4-16S, 4-16KS, 4-16KHS, 6-16S, 6-16HS, 6-16KS, 6-16KHS	
11805		10 years	8KS, 8KBS	
11806		10 years	8KS, 8KBS	
12082		7 years	1-14, 1-14K	
12083		7 years	1-14, 1-14K	
12084		7 years	1-14, 1-14K	
12085		7 years	1-14, 1-14K	
12092		5 years	1-14, 1-14K	
12093		5 years	1-14, 1-14K	
12094		5 years	1-14, 1-14K	
12096		5 years	1-14, 1-14K	
12097		5 years	1-14, 1-14K	
12134		5 years	1-16, 1-16K	
12135		5 years	1-16, 1-16K	
12137		5 years	1-16, 1-16K	
12500		7 years	6-16S, 6-16HS, 6-16KS, 6-16KHS	
12600		7 years	6-16S, 6-16HS, 6-16KS, 6-16KHS	
13035			2-7	Do not grease the load-bearing bolts of the rotor
13218	20,000		4-16S, 4-16KS, 4-16KHS, 6-16S, 6-16HS, 6-16KS, 6-16KHS	
13221	10,000		4-16S, 4-16KS, 4-16KHS, 6-16S, 6-16HS, 6-16KS, 6-16KHS	
13296	35,000	5 years	2-7, 2-16P, 2-16KL, 2-16KHL	Do not grease the load-bearing bolts of the rotor
13299		5 years	2-7, 2-16P, 2-16KL, 2-16KHL, 3-30KS, 3-30KHS	Do not grease the load-bearing bolts of the rotor
13635	25,000		6-16S, 6-16HS, 6-16KS, 6-16KHS	
13650	20,000		6-16S, 6-16HS, 6-16KS, 6-16KHS	
13845	20,000		8KS	
13850	10,000	10 years	8KS	
13860	15,000	10 years	8KBS	
91060	10,000		6-16S, 6-16HS	Special software required

11 Appendix

11.5 Resistance data



The data refer to resistance at 20°C.

- no data 1 resistant 2 practically resistant 3 partially resistant 4 not resistant	Medium	Formula	Concentration [%]	High Density Polyethylene	Polyamide	Polycarbonate	Polyoxymethylene	Polypropylene	Polysulfone	Polyvinyl chloride, hard	Polyvinyl chloride, soft	Polytetrafluorethylene	Acrylonitrile-butadiene- caoutchouc	Aluminium
				HDPE	PA	PC	POM	PP	PSU	PVC	PVC	PTFE	NBR	AL
	Acetaldehyde	C ₂ H ₄ O	40	3	2	4	2	3	4	4	-	1	4	1
	Acetamide	C ₂ H ₅ NO	saturated	1	1	4	1	1	4	4	-	1	-	1
	Acetone	C ₃ H ₆ O	100	1	1	4	1	1	4	4	-	1	4	1
	Acrylonitrile	C ₃ H ₃ N	100	1	1	4	3	3	4	4	4	1	4	1
	Allyl alcohol	C ₃ H ₆ O	96	1	3	3	2	2	2	2	4	1	1	1
	Aluminium chloride	AlCl ₃	saturated	1	3	2	4	1	-	1	-	1	1	4
	Aluminium sulfate	Al ₂ (SO ₄) ₃	10	1	1	1	3	1	1	1	1	1	1	1
	Ammonium chloride	(NH ₄)Cl	aqueous	1	1	1	2	1	1	1	1	1	1	3
	Ammonium hydroxide	NH ₃ + H ₂ O	30	1	3	4	1	1	2	1	-	1	-	1
	Aniline	C ₆ H ₇ N	100	1	3	4	1	2	4	4	4	1	4	1
	Anisole	C ₇ H ₈ O	100	3	4	4	1	4	4	2	-	1	4	1
	Antimony trichloride	SbCl ₃	90	1	4	1	4	1	-	1	-	1	-	4
	Benzaldehyde	C ₇ H ₆ O	100	1	3	4	1	1	3	4	4	1	4	1
	Benzene	C ₆ H ₆	100	3	2	4	1	3	4	4	-	1	4	1
	Boric acid	H ₃ BO ₃	aqueous	1	3	1	2	1	-	-	-	1	1	1
	Butyl acrylate	C ₇ H ₁₂ O ₂	100	1	2	4	2	3	4	4	4	1	-	1
	Butyl alcohol, normal	C ₄ H ₁₀ O	100	1	1	2	1	1	2	2	4	1	1	1
	Calcium chloride	CaCl ₂	alcoholic	1	4	2	3	1	-	-	4	1	1	3
	Carbon disulfide	CS ₂	100	4	3	4	2	4	4	4	4	1	3	1
	Carbon tetrachloride (TETRA)	CCl ₄	100	4	4	4	2	4	4	4	4	1	3	1
	Chlorine	Cl ₂	100	4	4	4	4	4	4	4	4	1	-	3
	Chlorine water	Cl ₂ x H ₂ O		3	4	4	4	3	-	3	3	1	-	4
	Chlorobenzene	C ₆ H ₅ Cl	100	3	4	4	1	3	4	4	4	1	4	1
	Chloroform	CHCl ₃	100	3	3	4	4	3	4	4	4	1	4	3

11 Appendix

- no data 1 resistant 2 practically resistant 3 partially resistant 4 not resistant		Concentration	High Density Polyethylene	Polyamide	Polycarbonate	Polyoxymethylene	Polypropylene	Polysulfone	Polyvinyl chloride, hard	Polyvinyl chloride, soft	Polytetrafluorethylene	Acrylonitrile-butadiene-caoutchouc	Aluminium	
			Medium	Formula	[%]	HDPE	PA	PC	POM	PP	PSU	PVC	PVC	PTFE
	Chromic acid	CrO ₃	10	1	4	2	4	1	4	1	-	1	4	1
	Chromic potassium sulphate	KCr(SO ₄) ₂ x 12H ₂ O	saturated	1	2	1	3	1	-	1	-	1	-	3
	Citric acid	C ₆ H ₈ O ₇	10	1	1	1	2	1	1	1	1	1	1	1
	Citric acid	C ₆ H ₈ O ₇	50	1	3	1	2	1	-	-	-	1	1	1
	Copper sulphate	CuSO ₄ x 5H ₂ O	10	1	1	1	1	1	1	1	1	1	1	4
	Cyclohexanol	C ₆ H ₁₂ O	100	1	1	3	1	1	1	1	4	1	2	1
	Decane	C ₁₀ H ₂₂	100	-	1	2	1	3	-	-	-	1	2	1
	Diaminoethane	C ₂ H ₈ N ₂	100	1	1	3	1	1	-	3	4	1	1	1
	Diesel fuel	—	100	1	1	3	1	1	-	1	3	1	1	1
	Dimethyl formamide (DMF)	C ₃ D ₇ NO	100	1	1	4	1	1	4	3	-	1	3	1
	Dimethyl sulfoxide (DMSO)	C ₂ H ₆ SO	100	1	2	4	1	1	4	4	-	1	-	1
	Dimethylaniline	C ₈ H ₁₁ N	100	-	3	4	2	4	-	-	-	1	-	1
	Dioxane	C ₄ H ₈ O ₂	100	2	1	4	1	3	2	3	4	1	3	1
	Dipropylene glycol (mono)methyl ether	C ₄ H ₁₀ O	100	3	1	4	1	4	4	4	4	1	-	1
	Ethyl acetate	C ₄ H ₈ O ₂	100	1	1	4	1	1	4	4	4	1	4	1
	Ethylene chloride	C ₂ H ₄ Cl ₂	100	3	3	4	1	3	4	4	4	1	-	1
	Ferrous chloride	FeCl ₂	saturated	1	3	1	3	1	1	1	1	1	-	4
	Formaldehyde solution	CH ₂ O	30	1	3	1	1	1	-	-	-	1	2	1
	Formic acid	CH ₂ O ₂	100	1	4	3	4	1	3	3	1	1	2	1
	Furfural	C ₅ H ₄ O ₂	100	1	3	3	2	4	-	-	-	1	4	1
	Gasoline	C ₅ H ₁₂ - C ₁₂ H ₂₆	100	2	1	3	1	3	3	2	-	1	1	1
	Glycerol	C ₃ H ₈ O ₃	100	1	1	3	1	1	1	1	2	1	1	1
	Heptane, normal	C ₇ H ₁₆	100	2	1	1	1	2	1	2	4	1	1	1
	Hexane, n-	C ₆ H ₁₄	100	2	1	2	1	2	1	2	4	1	1	1
	Hydrogen chloride	HCl	5	1	4	1	4	1	1	1	-	1	2	4
	Hydrogen chloride	HCl	concentrated	1	4	4	4	1	1	2	3	1	4	4
	Hydrogen peroxide	H ₂ O ₂	3	1	3	1	1	1	1	1	-	1	3	3
	Hydrogen peroxide	H ₂ O ₂	30	1	4	1	4	1	1	1	-	1	3	3
	Hydrogen sulphide	H ₂ S	10	1	1	1	1	1	1	1	3	1	3	1
	Iodine, tincture of	I ₂		1	4	3	1	1	-	4	4	1	1	1

11 Appendix

- no data 1 resistant 2 practically resistant 3 partially resistant 4 not resistant		Concentration	High Density Polyethylene	Polyamide	Polycarbonate	Polyoxymethylene	Polypropylene	Polysulfone	Polyvinyl chloride, hard	Polyvinyl chloride, soft	Polytetrafluorethylene	Acrylonitrile-butadiene-caoutchouc	Aluminium	
			Medium	Formula	[%]	HDPE	PA	PC	POM	PP	PSU	PVC	PVC	PTFE
	Isopropyl alcohol	C ₃ H ₈ O	100	1	1	1	1	1	1	1	4	1	-	2
	Lactic acid	C ₃ H ₆ O ₃	3	1	3	1	2	1	1	2	-	1	1	1
	Magnesium chloride	MgCl ₂	10	1	1	1	1	1	1	1	1	1	1	1
	Mercuric chloride	HgCl ₂	10	1	4	1	3	1	1	1	1	1	1	4
	Mercury	Hg	100	1	1	1	1	1	1	1	3	1	1	3
	Methyl acetate	C ₃ H ₆ O ₂	100	1	1	4	2	1	-	4	4	1	-	1
	Methyl alcohol	CH ₄ O	100	1	2	4	1	1	3	1	3	1	2	1
	Methyl benzene	C ₇ H ₈	100	3	1	4	1	3	4	4	4	1	4	1
	Methyl ethyl ketone (MEK)	C ₄ H ₈ O	100	1	1	4	1	1	4	4	4	1	4	1
	Methylene chloride	CH ₂ Cl ₂	100	4	3	4	3	3	4	4	4	1	-	1
	Mineral oil	—	100	1	1	1	1	1	1	1	-	1	1	1
	Nitric acid	HNO ₃	10	1	4	1	4	1	1	1	-	1	4	3
	Nitric acid	HNO ₃	100	4	4	4	4	4	-	4	-	1	4	1
	Nitrobenzene	C ₆ H ₅ NO ₂	100	3	4	4	3	2	4	4	4	1	4	1
	Oleic acid	C ₁₈ H ₃₄ O ₂	100	1	1	1	2	1	-	1	-	1	3	1
	Oxalic acid	C ₂ H ₂ O ₄ x 2H ₂ O	100	1	3	1	4	1	1	1	1	1	2	1
	Ozone	O ₃	100	3	4	1	4	3	1	1	-	1	4	2
	Petroleum	—	100	1	1	3	1	1	1	1	3	1	1	1
	Phenol	C ₆ H ₆ O	10	1	4	4	4	1	4	1	3	1	3	1
	Phenol	C ₆ H ₆ O	100	2	4	4	4	1	3	4	3	1	3	1
	Phosphoric acid	H ₃ PO ₄	20	1	4	2	4	1	-	-	-	1	2	4
	Phosphorus pentachloride	PCl ₅	100	-	4	4	4	1	-	4	4	1	-	1
	Potassium hydrogen carbonate	CHKO ₃	saturated	1	1	2	1	1	-	-	-	1	-	4
	Potassium hydroxide	KOH	30	1	1	4	3	1	1	1	1	1	-	4
	Potassium hydroxide	KOH	50	1	1	4	3	1	1	1	1	1	-	4
	Potassium nitrate	KNO ₃	10	1	1	1	1	1	-	-	-	1	1	1
	Potassium permanganate	KMnO ₄	100	1	4	1	1	1	-	1	-	1	3	1
	Pyridine	C ₅ H ₅ N	100	1	1	4	1	3	4	4	4	1	4	1
	Resorcinol	C ₆ H ₆ O ₂	5	1	4	2	3	1	4	2	-	1	-	2
	Silver nitrate	AgNO ₃	100	1	1	1	1	1	1	1	1	1	2	4

11 Appendix

- no data 1 resistant 2 practically resistant 3 partially resistant 4 not resistant		Concentration	High Density Polyethylene	Polyamide	Polycarbonate	Polyoxymethylene	Polypropylene	Polysulfone	Polyvinyl chloride, hard	Polyvinyl chloride, soft	Polytetrafluorethylene	Acrylonitrile-butadiene-caoutchouc	Aluminium
			Medium	Formula	[%]	HDPE	PA	PC	POM	PP	PSU	PVC	PVC
	Sodium bisulphite	NaHSO ₃	10	1	1	2	4	1	-	-	1	1	1
	Sodium carbonate	Na ₂ CO ₃	10	1	1	1	1	1	-	-	1	-	3
	Sodium chloride	NaCl	30	1	1	1	1	1	1	1	1	1	3
	Sodium hydroxide	NaOH	30	1	1	4	1	1	1	1	1	2	4
	Sodium hydroxide	NaOH	50	1	1	4	1	1	1	1	-	2	4
	Sodium sulfate	Na ₂ SO ₄	10	1	1	1	1	1	1	1	1	1	1
	Spirits	C ₂ H ₆ O	96	1	1	1	1	1	1	3	1	-	1
	Styrene	C ₈ H ₈	100	4	1	4	1	3	-	4	4	4	1
	Sulphuric acid	H ₂ SO ₄	6	1	4	1	4	1	1	1	-	2	3
	Sulphuric acid	H ₂ SO ₄	fuming	4	4	4	4	4	4	4	4	4	3
	Tallow	—	100	1	1	1	1	1	-	1	1	1	1
	Tetrahydrofuran (THF)	C ₄ H ₈ O	100	3	1	4	1	3	4	4	4	3	1
	Tetrahydronaphthalene	C ₁₀ H ₁₂	100	3	1	4	1	4	4	4	4	-	1
	Thionyl chloride	Cl ₂ SO	100	4	4	4	2	4	4	4	4	-	3
	Tin chloride	SnCl ₂	10	1	4	2	2	1	-	-	1	1	4
	Transformer oil	—	100	1	1	3	3	1	1	1	-	1	1
	Trichloroethane	C ₂ H ₃ Cl ₃	100	3	3	4	2	4	4	4	4	4	4
	Urea	CH ₄ N ₂ O	10	1	1	1	1	1	-	-	1	1	1
	Urine	—	100	1	1	1	1	1	-	1	1	-	2
	Vinegar	C ₂ H ₄ O ₂	10	1	4	1	1	1	1	1	1	2	1
	Vinegar	C ₂ H ₄ O ₂	90	1	4	4	4	1	3	1	4	-	1
	Wax	—	100	-	1	1		1	-	-	1	-	1
	Wines	—	100	1	1	1	2	1	1	1	1	-	4
	Xylene	C ₈ H ₁₀	100	3	1	4	1	4	4	4	4	4	1

11 Appendix

11.6 EC declaration of conformity



EC – DECLARATION OF CONFORMITY

The product named hereinafter was developed, designed, and manufactured in compliance with the relevant, fundamental safety and health requirements of the listed EC directives and norms.

In the event of modifications that were not authorised by us or if the product is used in a manner that is not in line with the intended purpose, this declaration will be rendered void.

<i>Product name:</i>	Laboratory centrifuge
<i>Product type:</i>	Sigma 2-16KL, Sigma 2-16KHL
<i>Order number:</i>	10350, 10351, 10352, 10353, 90903, 91277
<i>Directives:</i>	2006/42/EC Machinery Directive 2014/35/EU Low Voltage Directive 2014/30/EU EMC Directive (EU) 2015/863 RoHS Directive
<i>Normes:</i>	EN 61010-2-020:2017 EN 61010-2-011:2017 EN IEC 61000-3-2:2019 EN 61000-3-3:2020 EN 61326-1:2013

Sigma Laborzentrifugen GmbH

An der Unteren Söse 50
37520 Osterode
Germany

Authorised representative
for CE matters:
Eckhard Tödteberg

Osterode, 22/02/2022



General Manager

11 Appendix

11.7 Declaration of conformity – China RoHS 2



DECLARATION OF CONFORMITY

China RoHS 2 (Administrative Measures for the Restriction of the Use of Hazardous Substances in Electrical and Electronic Products)

Laboratory centrifuge models: Sigma 1-14, 1-14K, 1-7, 1-16, 1-16K, 2-7, 2-16P, 2-16KL, 2-16KHL, 3-16L, 3-16KL, 3-18KS, 3-18KHS, 3-30KS, 3-30KHS, 4-5L, 4-5KL; 4-5KRL, 4-16S, 4-16KS, 4-16KHS, 6-16S, 6-16HS, 6-16KS, 6-16KHS, 8KS, 8KBS

Sigma Laborzentrifugen GmbH has made reasonable effort to avoid the use of hazardous substances in the products it manufactures (laboratory centrifuges).

A Product Conformity Assessment (PCA) was performed in order to determine whether the concentration of harmful substances in all homogeneous materials of the component parts is above or below the MCV limit (Maximum Concentration Value limit) as defined in GB/T 26572:

Mercury and its compounds: 0.1 % Cadmium (Cd) and its compounds: 0.01 %
 Lead (Pb) and its compounds: 0.1 % Hexavalent chromium (Cr (VI)) and its compounds: 0.1 %
 Polybrominated biphenyls (PBB): 0.1 % Polybrominated diphenyl ethers (PBDE): 0.1 %

表1 产品中有害物质的名称及含量
 Table 1: Name and content of hazardous substances in the product

部件名称 Component part (PCA)	有害物质 Hazardous substance					
	铅 Lead (Pb)	汞 Mercury (Hg)	镉 Cadmium (Cd)	六价铬 Hexavalent Chromium (Cr (VI))	多溴联苯 Poly-brominated biphenyls (PBB)	多溴二苯醚 Polybrominated diphenyl ethers (PBDE)
Electronic PCB, cables	X ¹⁾	○	○	○	○	○
Display	○	○	○	○	○	○
Housing	X ²⁾	○	○	○	○	○
Base, metal, accessories	X ²⁾	○	○	○	○	○

本表格依据SJ/T 11364的规定编制。
 This table is made according to SJ/T 11364.

11 Appendix



O: 表示该有害物质在该部件所有均质材料中的含量均在GB/T 26572规定的限量要求以下。
Indicates that the content of the harmful substance in all homogeneous materials of the component part is below the limit as defined in GB/T 26572.)

X: 表示该有害物质至少在该部件的某一均质材料中的含量超出GB/T 26572规定的限量要求。(企业可在此处, 根据实际情况对上表打“X”的技术原因进行进一步说明。)
Indicates that the content of the harmful substance in at least one homogeneous material of the component part exceeds the limit as defined in GB/T 26572. (Contact the manufacturer for further technical information according to the actual situation.)

1) Contains parts in compliance with exemptions 6c, 7c.I, 7c.II and 37 of 2011/65/EU RoHS.

2) Contains parts in compliance with exemptions 6a, 6b and 6c of 2011/65/EU RoHS.

Apart from the exemptions given in this table, none of the substances listed above have been intentionally added to the product or metallic coatings.

Sigma Laborzentrifugen GmbH

An der Unteren Söse 50

37520 Osterode

Germany

Osterode, 08/11/2023

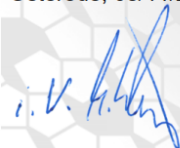

M. Weigoni, Director of Procurement

11.8 UKCA declaration of conformity



UKCA – DECLARATION OF CONFORMITY

The product named hereinafter was developed, designed, and manufactured in compliance with the relevant, fundamental safety and health requirements of the listed directives and norms.

In the event of modifications that were not authorised by us or if the product is used in a manner that is not in line with the intended purpose, this declaration will be rendered void.

<i>Product name:</i>	Laboratory centrifuge
<i>Product type:</i>	Sigma 2-16KL, Sigma 2-16KHL
<i>Order number:</i>	10350, 10353, 90903, 91277
<i>Manufacturer:</i>	Sigma Laborzentrifugen GmbH An der Unteren Söse 50 37520 Osterode am Harz Germany
<i>Directives:</i>	Supply of Machinery (Safety) Regulations 2008 Electrical Equipment (Safety) Regulations 2016 Electromagnetic Compatibility Regulations 2016 Restriction of the Use of Certain Hazardous Substances in Electrical and Electronic Equipment Regulations 2012
<i>Normes:</i>	EN 61010-2-020:2017 EN IEC 61000-3-2:2019 EN 61000-3-3:2020 EN 61326-1:2013

UK Authorised Representative:

**UK
CA** SciQuip Ltd
Newtown
Wem
Shropshire
SY4 5NU

Osterode, 08/12/2022

Michael Sander
General Manager

11 Appendix

12 Index

A

Acceleration	45
Acceleration curves.....	45, 70
Accessories	
changes in colour.....	61
changes in structure	61
deformation of tubes	61
Leaks.....	61
Accessories, cleaning and care.....	56
Acid.....	22, 55, 57
Activating the modification mode.....	39
Adapters	37, 56
Alkaline solutions	22, 55, 57
Ambient conditions.....	67
Ambient temperature	67
Anodised coating	56
Anti-friction coating	58
Application examples	13
Autoclaving	61
Automatic lid opening function	45
AutoOpen	45

B

Brake	45
Brief mains power failure.....	51
Bucket.....	37
Buckets, cleaning and care	57
Buzzer	46

C

Capacity.....	66
Capillary tubes	35
Carrier.....	37
Carrier systems.....	37
Carriers, cleaning and care	57
CE mark in compliance with the directive 2006/42/EC	15
Centrifugation of infectious, toxic, radioactive, or pathogenic substances.....	21
Centrifugation principle	13
Centrifugation with low capacity	36
Centrifugation with vessels of various sizes	35

Centrifuge cannot be started.....	51
Centrifuge decelerates during operation	51
Centrifuge is inclined.....	51
Centrifuge was moved during run	51
Centrifuge, cleaning and care	55
Centrifuges	
- definition.....	9
Changes in colour (accessories).....	61
Changes in structure (accessories).....	61
Chemical and biological safety.....	21
Chemical resistance of plastic.....	57
China RoHS 2 – Declaration of conformity .	79
Cleaning agents.....	60
Cleaning the bores of angle rotors	56
Cleaning the centrifuge	55
Closing the lid	20, 32
CO ₂ equivalent.....	66
Comfort rotor coating	24
Communication error	53
Condensation.....	30
Condenser dirty	51
Condenser, cleaning and care	56
Contamination.....	21, 56
Continuous heat resistance.....	60
Continuous run	41
Control system.....	38
Copyright	10
Corrosion	20, 23, 37, 55, 56, 57, 59
Cost estimate.....	63
Cracking	56
Cracks	57
Customer-provided fuses.....	31
Cycle display (Cycles).....	47
Cycles.....	32
Cycles (cycle display)	47
D	
Damage of the surface.....	57
Dangerous goods.....	22
Dangerous materials	60
Date of manufacture	12
Deceleration curves	45, 70

Index

Declaration of conformity	10, 77	H	
Declaration of conformity – China RoHS 2. 79		Hazard warnings.....	9, 32, 33, 37
Declaration of decontamination.....	63, 65	Heavy-duty grease for load-bearing bolts...	58
Decontamination agent	56, 60	Highly corrosive substances	21
Deformation of tubes (accessories).....	61	I	
Density.....	12, 22	Imbalance	35, 37
Different service life of rotors and accessories	23, 71	Imbalance error.....	53
Dimensions	28	Imbalance monitoring system	26
Direct hazard to the life and health.....	16	Importance of the operating manual.....	9
Directive 2002/96/EC	65	Important information	16
Disinfectants	60	Improper loading	51
Disinfection of the rotor chamber and accessories	60	Infectious substances	60
Display	38	Inflammable substances	21
Disposal of the centrifuge.....	65	Informal safety instructions	19
Disposal of the packaging	65	Initial start-up	32
Documentation.....	10	Input fuse	66
Drive problem	51	Input lock	48
E		Inspection by the manufacturer	62
Earth conductor check	26	Installation of a rotor	32
EC declaration of conformity	10, 77	Installation of accessories	35
EEPROM error.....	53	Installation of angle rotors with a hermetic lid	33
Electrical connection	66	Installation of rotors and accessories	32
Electrical safety.....	20	Installation of the microhaematocrit rotor ...	34
Emergency lid release	52	Installation site	30
Error correction	51	Insufficiently greased load-bearing bolts ...	58
Error message	51	Intended use	9
Explanation of the symbols and notes.....	16	Interrupting a centrifugation run	39
Explosive substances	21	Interrupting a deceleration process	39
F		IP code	66
Filling quantity (refrigerant)	66	K	
Fire preventions	21	Kinetic energy	12, 66
Form for the return of defective parts	63	L	
Freezing-over of the compressor	42	Layout of the centrifuge.....	11
Functional and operating elements	11	Leaks (accessories	61
Fuses have tripped	51	Lid cannot be opened	51
G		Lid error	53
General conditions	9	Lid lock device	26
Glass breakage.....	59	Lid lock has not released	51
Glass particles	59	Lid seal sticks	51
Global warming potential (GWP).....	66	Linear curves	70
Gravitational field	66	Loading a program.....	49
Grease for load-bearing bolts.....	55, 58		

M	
Mains power switch off.....	51
Mains switch	11
Mains voltage.....	20
Maintenance	55
Malfunctions and error correction.....	51
Manual mode	39
Manufacturer.....	66
Marking of the rotors.....	58
Marking of the unit	15
Maximum number of cycles	47
Maximum speed for tubes.....	37
Measures in the event of hazards and accidents.....	27
Mechanical safety	20
Microhaematocrit rotor, cleaning and care ..	59
Mode of operation.....	13
Motor error	53
Motor shaft.....	29, 32, 33, 55
Multiple carrier	37
N	
Name plate	11, 12
No indication on the display	51
No power in the mains supply	51
Noise level	66
Nominal voltage.....	12
Notes on safety and hazards	9
Notes on transport	28
O	
Online download of forms	64
Opening the lid.....	32
Operating personnel	18
Operating voltage.....	30
Operational safety.....	56
Overseas shipping	28
P	
Packaging	29
Parameter error	53
Pathogenic substances.....	21, 55, 60
Plastic accessories, cleaning and care.....	57
Potential hazard to the life and health	16
Potentially hazardous situation.....	16
Power consumption	12, 66
Power cord is not plugged in.....	51
Power supply	30
Preselection of a curve.....	45
Pressure (refrigerant).....	66
Pressure marks.....	57
Prevention of accidents.....	9
Problem description	63
Process error	53
ProgLock program lock	46
Program "Rapid Temp"	43
Program lock (ProgLock)	46
Protection class	30, 66
Q	
Qualified electrician.....	18
Quick stop.....	39
Quitting the modification mode.....	39
R	
Radioactive substances	21, 55
Radius	14
Rapid Temp program	43
Reaching the maximum number of cycles..	47
Refrigerant.....	66
Refrigerant data	12, 66
Relative centrifugal force (RCF).....	14, 40
Removal of the transport safety device	29
Remove glass particles and metal dust from the rotor chamber.....	59
Removing a rotor	33, 34
Requirements concerning the personnel....	18
Responsibility of the operator.....	17
Return of centrifuges, spare parts, or accessories	63
Return of defective parts	63
Rotor chamber	42, 55
Rotor coating Sigma "Comfort"	24
Rotor monitoring system	26
Rotor radii	68
Rotor selection.....	44
Rotor tie-down screw	32, 33, 57
Rotor wrench	32, 33
Rotors and accessories with a different service life	23, 71
Rotors for microtiter plate formats	33
Rotors with Sigma.....	58
Rotors, cleaning and care	57
Runtime	40

Index

Runtime as of the set speed	41	Stress-corrosion	
S		see	
Safety area	22	corrosion	57
Safety devices	26	Structural changes	21
Safety distance	20	Supply voltage	30
Safety instructions.....	9, 32, 33, 37	Switching the centrifuge off	50
Safety instructions concerning the		Switching the centrifuge on	32
centrifugation process	22	System check	26
Safety of rotors and accessories	22	System error	51, 53
Safety range	22, 30	T	
Safety, chemical and biological	21	Table of error codes.....	53
Safety, electrical	20	Table of rotors and accessories with a	
Safety, mechanical.....	20	different service life	23, 71
Safety-conscious work	17	Technical data	66
Saving a program.....	49	Technical documentation	67
Scope of supply	10	Temperature error.....	53
Selection, display, and modification of data	39	Temperature inside the rotor chamber	26
Serial number	12, 54, 62	Temperature monitoring system.....	26
Service.....	62	Temperature range	66
Service contact	54	Temperature value not reached	51
Service life	55	Thermal stress	55
Service life of rotors and accessories... 23, 71		Time range.....	66
Service life of the accessories.....	61	Toxic substances	21, 55
Service work	62	Transport safety device.....	29
Set-up and connection	30	Tubes.....	37
Short run	42	Type.....	12, 66
Sigma	24, 58	Type of connection.....	30
Solvents.....	22, 55, 57	Type of the centrifuge	54, 62
Sound signal (buzzer)	46	U	
Spare part enquiries.....	54	UKCA declaration of conformity	81
Specialised personnel.....	18	Ungreased load- bearing bolts	51
Speed	12, 14, 40, 66	Useful volume	
Speed-gravitational-field-diagram	69	- volume that is stated for the tube	37
Speedometer error.....	53	User interface	38
Standards and regulations	10	UV radiation	30, 55
Standstill monitoring system	26	V	
Starting a centrifugation run	39	Vents	30
Sterilisation of the rotor chamber and		Vessels	37
accessories	60	W	
Stopping of the centrifuge due to an		Warranty and liability.....	9
imbalance.....	58	Wear.....	62
Storage and transport	28	Weight	28
Storage conditions	28		
Storage locations	66		