



Sigma 1-7

from serial no. 181096



Laboratory centrifuge

Operating Manual

Please retain for later use!

© Copyright by
Sigma Laborzentrifugen GmbH
An der Unteren Söse 50
37520 Osterode am Harz
Germany

Tel.: +49 (0) 5522 / 5007-0
Fax: +49 (0) 5522 / 5007-12
Web: www.sigma-zentrifugen.de
E-mail: info@sigma-zentrifugen.de

Table of contents

1	General information	9
1.1	Importance of the operating manual.....	9
1.2	Intended use.....	9
1.3	Warranty and liability.....	9
1.4	Copyright.....	10
1.5	Standards and regulations.....	10
1.6	Scope of supply.....	10
2	Layout and mode of operation	11
2.1	Layout of the centrifuge.....	11
2.1.1	Functional and operating elements.....	11
2.1.2	Name plate.....	12
2.2	Mode of operation.....	13
2.2.1	Centrifugation principle.....	13
2.2.2	Area of application.....	13
2.2.2.1	Speed, radius, and relative centrifugal force.....	14
2.2.2.2	Density.....	14
3	Safety	15
3.1	Marking of the unit.....	15
3.2	Explanation of the symbols and notes.....	16
3.3	Responsibility of the operator.....	17
3.4	Requirements concerning the personnel.....	18
3.5	Informal safety instructions.....	19
3.6	Safety instructions.....	20
3.6.1	Electrical safety.....	20
3.6.2	Mechanical safety.....	20
3.6.3	Fire prevention.....	21
3.6.4	Chemical and biological safety.....	21
3.6.5	Safety instructions for centrifugation.....	22
3.6.6	Resistance of plastics.....	22
3.6.7	Safety of rotors and accessories.....	23
3.6.7.1	Service life of rotors and accessories.....	23
3.7	Safety devices.....	23
3.7.1	Lid lock device.....	23
3.7.2	Standstill monitoring system.....	24
3.7.3	System check.....	24
3.7.4	Earth conductor check.....	24
3.8	Measures in the event of hazards and accidents.....	24
3.9	Remaining hazards.....	24

Table of contents

4	Storage and transport	25
4.1	Dimensions and weight.....	25
4.2	Storage conditions	25
4.3	Notes on transport	25
4.4	Packaging.....	26
4.5	Transport safety device.....	26
5	Set-up and connection	27
5.1	Installation site	27
5.2	Power supply	27
5.2.1	Type of connection	27
5.2.2	Customer-provided fuses.....	28
6	Using the centrifuge	29
6.1	Initial start-up	29
6.2	Switching the centrifuge on	29
6.2.1	Opening and closing the lid.....	29
6.2.2	Installation of rotors and accessories	30
6.2.2.1	Installation of a rotor	30
6.2.2.2	Installation of accessories	31
6.2.2.3	Vessels	31
6.3	Control System "Spincontrol Basic"	32
6.3.1	User interface	32
6.3.2	Display.....	32
6.3.3	Starting a centrifugation run.....	33
6.3.4	Interrupting a centrifugation run	33
6.3.5	Interrupting a deceleration process.....	33
6.3.6	Speed / Relative centrifugal force (RCF).....	33
6.3.6.1	Changing the speed/RCF value during centrifugation	33
6.3.7	Runtime	34
6.3.7.1	Changing the runtime during centrifugation.....	34
6.3.7.2	Short run	34
6.3.7.3	Continuous run.....	35
6.3.8	Softstart and softstop function	35
6.3.9	Rotor selection.....	36
6.3.10	Programs.....	37
6.3.10.1	Saving the current settings.....	37
6.3.10.2	Calling up stored programs	37
6.4	Switching the centrifuge off	37
7	Malfunctions and error correction	38
7.1	General malfunctions	38
7.1.1	Emergency lid release	39
7.2	Table of error codes.....	40
7.3	Service contact	41

Table of contents

8	Maintenance and service	42
8.1	Maintenance	42
8.1.1	Centrifuge	42
8.1.2	Accessories	43
8.1.2.1	Plastic accessories	43
8.1.3	Rotors.....	44
8.1.4	Glass breakage	44
8.2	Sterilisation and disinfection of the rotor chamber and accessories	45
8.2.1	Autoclaving.....	46
8.3	Service	47
8.4	Return of defective centrifuges or parts	48
9	Disposal	50
9.1	Disposal of the centrifuge	50
9.2	Disposal of the packaging.....	50
10	Technical data	51
10.1	Ambient conditions	52
10.2	Technical documentation	52
11	Appendix	53
11.1	Range of accessories	53
11.1.1	Rotor radii.....	53
11.2	Speed-gravitational-field-diagram	54
11.3	Table of the service life of rotors and accessories.....	55
11.4	Resistance data	56
11.5	EC declaration of conformity	61
11.6	Declaration of conformity – China RoHS 2.....	63
11.7	UKCA declaration of conformity	65
12	Index	67

Table of contents

1 General information

1.1 Importance of the operating manual

A fundamental requirement for the safe and trouble-free operation of the centrifuge is to be familiar with the fundamental safety instructions and all possible hazards.

The operating manual includes important information concerning the safe operation of the centrifuge.

This operating manual and, in particular, the notes on safety and hazards must be observed by all persons operating the centrifuge.

In addition, the local rules and regulations for the prevention of accidents must be complied with.

1.2 Intended use

Centrifuges are power-driven machines that separate liquids from solid matter, liquid mixtures, or solid mixtures by centrifugal force. They are solely intended for this purpose. Any other use beyond this area of application is regarded as improper use. Sigma Laborzentrifugen GmbH cannot be held liable for any damage resulting from such improper use.

The intended use also includes

- observation of all the notes and instructions included in the operating manual and
- compliance with the care, cleaning, and maintenance instructions.

1.3 Warranty and liability

The warranty and liability are subject to our "General Conditions" that were distributed to the operator upon the conclusion of the contract.

Warranty and liability claims are excluded if they are due to:

- improper use.
- non-compliance with the safety instructions and hazard warnings in the operating manual.
- improper installation, start-up, operation, or maintenance of the centrifuge.

1 General information

1.4 Copyright

The copyright concerning the operating manual remains with Sigma Laborzentrifugen GmbH.

The operating manual is solely intended for the operator and their personnel. It includes instructions and information that must not be

- duplicated,
- distributed, or
- communicated in any other way.

Non-compliance may be prosecuted under criminal law.

1.5 Standards and regulations

These operating instructions have been created in accordance with the relevant European standards and regulations (see chapter 11.5 - "EC declaration of conformity").

1.6 Scope of supply

The centrifuge comprises:

- 1 power cord with IEC C13 connector Part no. 269 010
- 1 socket wrench, size 4 (rotor) Part no. 930 050
- 1 socket wrench, size 6 (emergency release) Part no. 930 056

Documentation

Operating manual incl. EC declaration of conformity
(see chapter 11.5 - "EC declaration of conformity")

Accessories

According to your order, our order confirmation, and your delivery note.

2 Layout and mode of operation

2.1 Layout of the centrifuge

2.1.1 Functional and operating elements

- 1 Lid
- 2 Display
- 3 User interface
(see chapter 6.3.1 -
"User interface")



Fig. 1: Total view of the centrifuge

- 4 Mains power switch
- 5 Mains power input
- 6 Name plate
(see chapter 2.1.2 -
"Name plate")



Fig. 2: Rear view of the centrifuge

2 Layout and mode of operation

2.1.2 Name plate

- 1 Manufacturer
- 2 Power consumption
- 3 Max. speed
- 4 Max. kinetic energy
- 5 Serial number
- 6 Part number
- 7 Nominal voltage
- 8 Type
- 9 Consult operating manual
- 10 Symbol for special disposal (see chapter 9 - "Disposal")
- 11 CE mark in compliance with the directive 2006/42/EC
- 12 Date of manufacture
- 13 Max. permissible density

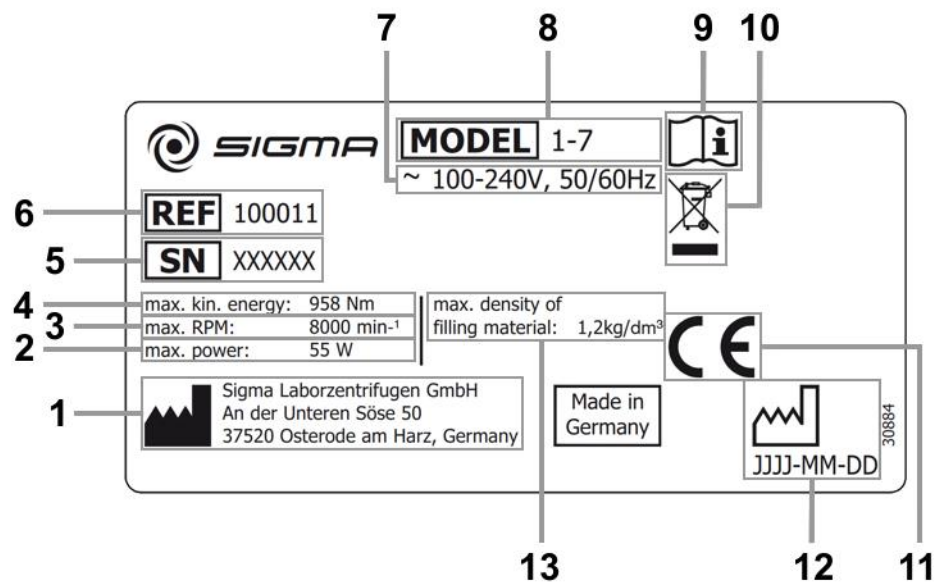

Fig. 3: Example of a name plate

2.2 Mode of operation

2.2.1 Centrifugation principle

Centrifugation is a process for the separation of heterogeneous mixtures of substances (suspensions, emulsions, or gas mixtures) into their components. The mixture of substances, which rotates on a circular path, is subject to centripetal acceleration that is several times greater than the gravitational acceleration.

Centrifuges use the mass inertia inside the rotor chamber for separating the substances. Due to their higher inertia, particles or media with a higher density travel outwards. In doing so, they displace the components with a lower density, which in turn travel towards the centre.

The centripetal acceleration of an object inside a centrifuge, as the effect of centripetal force, depends on the distance between the object and the axis of rotation as well as on the angular velocity. It increases linearly as a function of the distance with regard to the axis of rotation and quadratically as a function of the angular velocity. The bigger the radius in the rotor chamber is and the higher the speed is, the higher the centripetal acceleration is. However, the forces acting on the rotor also increase.

2.2.2 Area of application

Depending on the area of application of the centrifuge and also on the particle size, solids content, and volume throughput of the mixture of substances that is to be centrifuged, there are different types of centrifuges. The areas of application go from household use as a salad spinner or honey separator up to specialised technical applications in the clinical, biological, or biochemical context:

- For numerous clinical examinations, cellular material must be separated from the liquid to be analysed. The normal separation process can be sped up considerably by using laboratory centrifuges.
- In the metal-working industry, centrifuges are used for separating oil from metal cuttings. Dairies use centrifuges in order to separate cow's milk into cream and low-fat milk.
- Particularly big centrifuges are used in the sugar industry for separating the syrup from the crystalline sugar.
- Ultracentrifuges are predominantly used in biology and biochemistry in order to isolate particles, e.g. viruses. They are specifically designed for high speeds up to 500,000 rpm. The rotor moves in a vacuum in order to avoid air friction.

2 Layout and mode of operation

2.2.2.1 Speed, radius, and relative centrifugal force

The acceleration g , which the samples are subject to, can be increased by increasing the radius in the rotor chamber and by increasing the speed. These three parameters are interdependent and linked with each other via the following formula:

$$\text{Relative centrifugal force RCF} = 11.18 \times 10^{-6} \times r \times n^2$$

r = radius in cm

n = speed in rpm

RCF without any dimension

If two values are entered, the third value is determined by way of the stated formula. If, afterwards, the speed or the radius is changed, the resulting relative centrifugal force will be recalculated automatically by the control unit. If the RCF is changed, the speed will be adapted while the specified radius is maintained.

The speed-gravitational-field-diagram provides an overview of the relationship between speed, radius, and RCF (see chapter 11.2 - "Speed-gravitational-field-diagram").

2.2.2.2 Density

The laboratory centrifuge is suitable for the separation of constituents of different densities in mixtures with a maximum density of 1.2 g/cm^3 . All information concerning the speed of rotors and accessories refers to liquids with a density corresponding to this specification. If the density is above this value, the maximum permissible speed of the centrifuge must be reduced based on the following formula:









$$n = n_{max} \times \sqrt{(1.2/\rho)}$$

ρ = density in g/cm^3

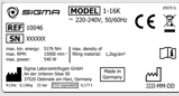
3 Safety

3.1 Marking of the unit

The following symbols are used on this centrifuge:

 <p>On (Power)</p>	 <p>Arrow indicating the direction of rotation</p>
 <p>Off (Power)</p>	 <p>Name plate (see chapter 2.1.2 - "Name plate")</p>
 <p>CE mark in compliance with the directive 2006/42/EC</p>	 <p>Do not dispose as part of domestic waste</p>
 <p>Consult operating manual</p>	 <p>RCM mark (only for Australia)</p>
 <p>China RoHS 2 mark (only for China)</p>	 <p>UKCA mark (only for UK)</p>

i
NOTE

Safety indications on the centrifuge must be kept readable at all times. If necessary, they must be replaced.

i
NOTE

The marking varies depending on the version and country of destination of the centrifuge.

3 Safety

3.2 Explanation of the symbols and notes

In this operating manual, the following names and symbols to indicate hazards are used:



This symbol stands for a **direct** hazard to the life and health of persons.

Non-observance of these symbols **causes** serious health problems up to life-endangering injuries.



This symbol stands for a **direct** hazard to the life and health of persons due to electrical voltage.

Non-observance of these symbols **causes** serious health problems up to life-endangering injuries.



This symbol stands for a **potential** hazard to the life and health of persons.

Non-observance of these symbols **can** cause serious health problems up to life-endangering injuries.



This symbol indicates a potentially hazardous situation

Non-observance of these notes can cause minor injuries or damage to property.



This symbol indicates important information.

3.3 Responsibility of the operator

The operator is responsible for authorising only qualified personnel to work on the centrifuge (see chapter 3.4 - "Requirements concerning the personnel").

The areas of responsibility of the personnel concerning the operation, maintenance, and care of the unit must be clearly defined.

The safety-conscious work of the personnel in compliance with the operating manual and the relevant EC and national health and safety regulations as well as with the accident prevention regulations must be checked at regular intervals (e.g. every month).

Under the international rules for health and safety at work, the operator is obliged to:

- take measures in order to prevent all danger to life or health during work.
- ensure that centrifuges are operated properly and entirely as intended (see chapter 1.2 - "Intended use").
- take protective measures against fire and explosion when working with hazardous substances.
- take measures for the safe opening of centrifuges.

The operator must perform a risk assessment concerning potential accidents in connection with the centrifuge and take design-related countermeasures, if necessary.

The centrifuge has to be maintained regularly (see chapter 8 - "Maintenance and service").

Components that are not in a perfect state must be replaced immediately.

3 Safety

3.4 Requirements concerning the personnel



DANGER

Risk of injury if the personnel are not sufficiently qualified

If unqualified personnel perform work on the centrifuge or are present in the danger zone of the centrifuge, hazards result that can cause serious injuries and considerable damage to property.

- Ensure that all the tasks are performed by personnel with the corresponding qualifications.
- Ensure that unqualified personnel stay clear of the danger zones.



DANGER

Risk of fatal injury to unauthorised persons due to hazards in the danger zone or work area

Unauthorised persons who do not fulfil the requirements described herein are not aware of the hazards in the work area. This is why there is a risk of serious or even fatal injuries for unauthorised persons.

- Ensure that unauthorised persons stay clear of the danger zone and work area.
- If in doubt, address these persons and instruct them to leave the danger zone and work area.
- Interrupt any running work if unauthorised persons are present in the danger zone or work area.

This manual uses the following personnel qualifications for various areas of activity:

Qualified electrician

Due to their special training, knowledge, experience and familiarity with the relevant standards and regulations, qualified electricians are in the position to perform work on electrical systems and to autonomously identify and prevent possible hazards.

Qualified electricians have been specifically trained for the environment in which they work and they are familiar with all the relevant standards and regulations.

Qualified electricians must fulfil the requirements as set out in the applicable legal provisions concerning the prevention of accidents.

Specialised personnel

Due to their special training, knowledge, experience and familiarity with the relevant regulations, specialised personnel are in the position to perform any tasks assigned to them and to autonomously identify and prevent possible hazards.

Operating personnel

Only trained, specialised personnel are authorised to operate the unit. The persons operating the unit must

- be familiar with the fundamental health, safety, and accident prevention regulations,
- have read and understood this operating manual, in particular the safety sections and warning notes, and confirmed this with their signature,
- have been instructed in the operation and maintenance of this centrifuge.

3.5 Informal safety instructions

- This operating manual is a part of the product.
- The operating manual must be kept at the location of use of the centrifuge. Ensure that it is accessible at all times.
- The operating manual must be handed over to any subsequent owner or operator of the centrifuge.
- Any changes, additions or updates received must be added to the operating manual.
- In addition to the operating manual, the general and local rules and regulations concerning the prevention of accidents and the protection of the environment must also be supplied.
- Safety and danger indications on the centrifuge must be kept readable at all times. If necessary, they must be replaced.

3 Safety

3.6 Safety instructions

3.6.1 Electrical safety

As protection against electric shock, the centrifuge is equipped with an earthed mains power cable and connector. To ensure the effectiveness of this safety feature, the following must be ensured:



DANGER

- Ensure that the wall socket is properly wired and grounded.
- Check that the mains voltage agrees with the nominal voltage listed on the name plate.
- Ensure that the mains power cable is intact prior to using the centrifuge. Damaged or faulty mains power cables must be replaced immediately.
- Do not place vessels containing liquid on the centrifuge lid or within the safety distance of 30 cm around the centrifuge. Spilled liquids may get into the centrifuge and damage electrical or mechanical components.
- Only qualified and specialised personnel are authorised to perform service tasks or repairs of the electrical system for which the housing needs to be removed.
- Inspect the electrical equipment of the unit regularly. Defects such as loose or burnt cables must be eliminated immediately.
- Following the completion of any type of repair or service, the qualified and specialised personnel must perform final inspection and testing in compliance with the relevant standards.

3.6.2 Mechanical safety

In order to ensure the safe operation of the centrifuge, observe the following:



WARNING

- Do not open the lid when the rotor is in motion!
- Do not reach into the rotor chamber when the rotor is in motion!
- Do not use the centrifuge if it was installed incorrectly.
- Do not use the centrifuge without panels.
- Do not use the centrifuge if the rotors and inserts show signs of corrosion or other defects.
- Never operate the instrument without a rotor installed.
- Only use the centrifuge with rotors and accessories that have been approved by the manufacturer. In case of doubt, contact the manufacturer (see chapter 7.3 - "Service contact").
- Do not hold your fingers between the lid and the housing when closing the lid. Risk of crushing!
- Defective lid relieving devices could cause the centrifuge lid to fall (contact the service department, if necessary). Risk of crushing!
- Do not hit or move the centrifuge during its operation.
- Do not lean against or rest on the centrifuge during its operation.

WARNING

- Do not spin any substances that could damage the material of the rotors and buckets of the centrifuge in any way. Highly corrosive substances, for example, damage the material and affect the mechanical strength of the rotors and buckets.
- Stop the centrifuge immediately in the event of a malfunction. Eliminate the malfunction (see chapter 7 - "Malfunctions and error correction") or inform the service department of Sigma Laborzentrifugen GmbH (see chapter 7.3 - "Service contact").
- If the housing becomes damaged, do not use the centrifuge. Contact the service department of Sigma Laborzentrifugen GmbH (see chapter 7.3 - "Service contact").
- Ensure that all repairs are performed only by authorised and specialised personnel.
- Prior to any start-up, check the centrifuge, rotor, and accessories for signs of damage that can be discerned from the outside. Special attention must be paid to all of the rubber parts (e.g. motor cover, lid seal, and adapters) in terms of visible structural changes. Defective parts must be replaced immediately.
- Open the centrifuge when it is not in use so that moisture can evaporate.

3.6.3 Fire prevention

DANGER

- Do not spin explosive or inflammable substances.
- Do not use the centrifuge within hazardous locations.

3.6.4 Chemical and biological safety

If pathogenic, toxic, or radioactive samples are intended to be used in the centrifuge, it is in the responsibility of the user to ensure that all necessary safety regulations, guidelines, precautions, and practices are adhered to accordingly.

DANGER

- Infectious, toxic, pathogenic, and radioactive substances may only be used in special, certified containment systems with a bio-seal in order to prevent the material from being released.
- Take suitable precautions for your own safety if there is a risk of toxic, radioactive, or pathogenic contamination
- Materials that chemically react with each other with a high level of energy are prohibited.

WARNING

- Keep informed about local measures to avoid harmful emissions (depending on the substances to be centrifuged).
- Protective clothing is not required for the operation of the centrifuge. The materials to be centrifuged may, however, require special safety measures (e.g. centrifugation of infectious, toxic, radioactive, or pathogenic substances).

3 Safety

3.6.5 Safety instructions for centrifugation

For safe operation, observe the following before starting the centrifuge:



WARNING

- Ensure that the centrifuge was set up properly (see chapter 5 - "Set-up and connection").
- Keep a safety range of at least 30 cm free around the centrifuge as well as with regard to walls and other devices.
- Do not store any dangerous goods in the centrifuge area.
- Do not stay in the safety area longer than what is absolutely necessary for the operation of the centrifuge.
- Only use the centrifuge with rotors and accessories that have been approved by the manufacturer. We explicitly warn against the use of equipment of poor quality. Breaking glass or bursting vessels can cause dangerous imbalances at high speeds.
- Ensure that the rotor and buckets are correctly fitted (see chapter 6.2.2.1 - "Installation of a rotor").
- Observe the instructions on the installation of accessories (see chapter 6.2.2.2 - "Installation of accessories").
- The rotor must be loaded in a rotationally symmetrical manner at equal weights.
- If liquids with a density $> 1.2 \text{ g/cm}^3$ are used, reduce the speed (see chapter 2.2.2.2 - "Density").
- Do not use the centrifuge if the rotor is loaded asymmetrically.
- Do not use the centrifuge with tubes that are excessively long.

3.6.6 Resistance of plastics

Chemical influences have a strong effect on the polymeric chains of plastics, and, therefore, on their physical properties. Plastic parts can be damaged if solvents, acids, or alkaline solutions are used.



NOTE

- Refer to the resistance data (see chapter 11.4 - "Resistance data")!

3.6.7 Safety of rotors and accessories

3.6.7.1 Service life of rotors and accessories

The rotors and accessories have a limited service life.



WARNING

- Perform regular checks (at least once per month) for safety reasons!
 - Pay special attention to changes, such as corrosion, cracks, material abrasion, etc.
-
- After 10 years, they must be inspected by the manufacturer.
 - After 50,000 cycles, the rotor must be scrapped for reasons of safety.
 - If other data concerning the service life are engraved on the rotor or bucket, these data shall apply accordingly. For example, a bucket with the engraving "max. cycles = 10,000" has a service life of 10,000 cycles, and a rotor with the engraving "Exp. date 01/27" must be scrapped in January 2027 at the latest (see figure).
 - If a specification concerning the maximum number of cycles **and** a specification concerning the service life (i.e. a date) are provided, the specification that occurs first shall apply.



Fig. 4: Different service life – engraving on the bucket/rotor



NOTE

- Refer to the table of the service life of rotors and accessories (see chapter 11.3 - "Table of the service life of rotors and accessories")!

3.7 Safety devices

3.7.1 Lid lock device

The centrifuge can only be started when the lid is properly closed. The electrical lock must be locked. The lid can only be opened when the rotor has stopped. If the lid is opened by way of the emergency release system during operation, the centrifuge will immediately switch off and decelerate brakeless. If the lid is open, the drive is completely separated from the mains power supply, i.e. the centrifuge cannot be started (see chapter 7.1.1 - "Emergency lid release").

3 Safety

3.7.2 Standstill monitoring system

Opening of the centrifuge lid is only possible if the rotor is at a standstill. This standstill is checked by the microprocessor.

3.7.3 System check

An internal system check monitors the data transfer and sensor signals with regard to plausibility. The system continuously performs a self-check and identifies malfunctions. Malfunctions are indicated by error messages with a number in the speed/rcf display (see chapter 7.2 - "Table of error codes").

3.7.4 Earth conductor check

An earth conductor check can be carried out by authorised and specialised personnel using a suitable measuring instrument. Please contact the Sigma service department (see chapter 7.3 - "Service contact").

3.8 Measures in the event of hazards and accidents



DANGER

- If an emergency arises, switch off the centrifuge immediately!
- If in doubt, call the emergency doctor!

3.9 Remaining hazards

The centrifuge was built in accordance with the state of the art and in compliance with the generally recognized safety rules. However, danger to life and limb of the operator, or of third parties, or impairments of the unit or other material assets cannot be completely excluded when the unit is being used.

- Use the unit only for the purpose that it was originally intended for (see chapter 1.2 - "Intended use").
- Use the unit only if it is in a perfect running state.
- Immediately eliminate any problems that can affect safety.

4 Storage and transport

4.1 Dimensions and weight

	Sigma 1-7
Height:	271 mm
Height with open lid:	527 mm
Width:	310 mm
Depth:	418 mm
Weight:	13 kg

4.2 Storage conditions

The centrifuge can be stored in its original packaging for up to a year.

- Store the centrifuge only in dry rooms.
- The permissible storage temperature is between -20°C and +60°C.
- If you would like to store it for more than one year, or if you intend to ship it overseas, please contact the manufacturer.

4.3 Notes on transport

- When lifting the centrifuge, always reach under the centrifuge from the side.



CAUTION

The centrifuge weighs approx. 13 kg!

- For transport use suitable packaging and, if at all possible, the original packaging (see chapter 4.4 - "Packaging").

4 Storage and transport

4.4 Packaging

The centrifuge is packaged in a cardboard box.

- Open the box.
- Take out the box containing the accessories.
- Lift the centrifuge with both foam cushions out of the cardboard box. When lifting the centrifuge, always reach under the centrifuge from the side.



CAUTION

The centrifuge weighs approx. 13 kg!

- Retain the packaging for any possible future transport of the centrifuge.

4.5 Transport safety device

The centrifuge is not equipped with a transport safety device.

5 Set-up and connection

5.1 Installation site

Operate the centrifuge only in closed and dry rooms.

All the energy supplied to the centrifuge is converted into heat and emitted to the ambient air.

- Ensure sufficient ventilation.
- Keep a safety range of at least 30 cm free around the centrifuge as well as with regard to walls or other devices so that the vents in the machine remain unobstructed and fully effective.
- Do not subject the centrifuge to thermal stress, e.g. by positioning it near heat generators.
- Avoid direct sunlight (UV radiation).
- The table must be stable and have a solid, even surface.
- Attention: During transport from cold to warmer places, condensational water will collect inside the centrifuge. It is important to allow sufficient time for drying (min. 24 h) before the centrifuge can be used again.

5.2 Power supply

5.2.1 Type of connection



DANGER

The operating voltage on the name plate must correspond to the local supply voltage!



CAUTION

The mains power plug is an isolating device which is why it must be accessible at all times.

Sigma centrifuges are units of protection class I. The centrifuges of this model series have a three-wire power cord with an IEC C13 connector.



NOTE

The removable power cord must not be longer than 3 m!
The power cord must not be replaced with a power cord of inadequate rating!

5 Set-up and connection

5.2.2 Customer-provided fuses

Typically, the centrifuge must be protected with 16 Amp B fuses that are to be provided by the customer.



To ensure safe disconnection in the event of a fault, an AC/DC-sensitive RCD (residual current device) must be integrated in the wiring system of the building.

6 Using the centrifuge

6.1 Initial start-up



DANGER

- Before the initial start-up, please ensure that your centrifuge is properly set up and installed (see chapter 5 - "Set-up and connection").

6.2 Switching the centrifuge on

- Press the mains power switch.
The display then illuminates. The centrifuge is ready for operation.

6.2.1 Opening and closing the lid

The lid can be opened if the centrifuge is at a standstill.

- Press the lid key in order to open the lid.

The centrifuge cannot be started if the lid is opened.

- To close, press with both hands slightly on the lid until the lid lock is locked.



WARNING

Do not place your fingers between the lid and the housing when closing the lid. Risk of crushing!

6 Using the centrifuge

6.2.2 Installation of rotors and accessories

6.2.2.1 Installation of a rotor

- Open the centrifuge lid by pressing the lid key.
- Loosen the rotor tie-down screw by turning it anti-clockwise, but do not remove it.
- Lower the rotor with its central bore straight down onto the motor shaft.
- Tighten the rotor tie-down screw clockwise with the supplied rotor wrench with 3 Nm. In doing so, hold the rotor at its outer rim.
- Follow the safety instructions and hazard warnings (see chapter 3 - "Safety")!



WARNING

Once a day or after 20 cycles, the rotor tie-down screw must be loosened by some turns, and the rotor must be lifted and fastened again. This ensures a proper connection between the rotor and the motor shaft.



NOTE

Rotors can be used without a cover. This leads, however, to higher levels of noise and temperatures when running.

Removing a rotor

- Loosen the rotor tie-down screw by turning it anti-clockwise and remove the rotor.

6.2.2.2 Installation of accessories

- Only use tubes that are suitable for the rotor.
- Always load the axial symmetrical inserts of the rotors with the same accessories and fill to avoid imbalance.

Centrifugation with low capacity

- Install the tubes axial symmetrically so that the rotor is loaded evenly.
- It is not permissible to load angle rotors on only one axis.

correct

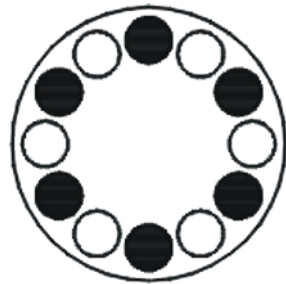
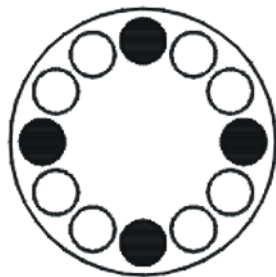

incorrect

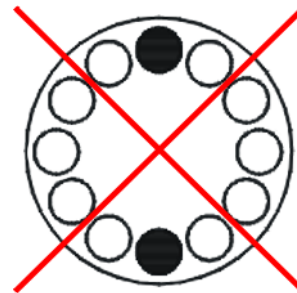

Fig. 5: Permissible and impermissible loading of an angle rotor (example illustration)

6.2.2.3 Vessels

- Load the vessels outside of the centrifuge. Liquids in the bores of the rotor cause corrosion.
- Fill the vessels carefully and arrange them according to their weight. Imbalances result in the excessive wear of the bearings.
- After the centrifugation, remove the vessels carefully in order to prevent the samples from mixing.
- Follow the safety instructions and hazard warnings (see chapter 3 - "Safety")!

6 Using the centrifuge

6.3 Control System "Spincontrol Basic"

6.3.1 User interface

- 1 Display
- 2 Set key
- 3 Program key
- 4 Arrow keys
- 5 Lid key
- 6 Start/Stop key
- 7 Quick run key



Fig. 6: User interface

The centrifuge is started directly via the user interface. When the centrifuge is switched on, all segments will be illuminated for a short time. It is now ready for operation.

6.3.2 Display

The centrifuge display has the following display fields:

- 1 Field for deceleration curves, run mode, and programs
- 2 Speed / RCF field
- 3 Time field
- 4 Field for rotor selection

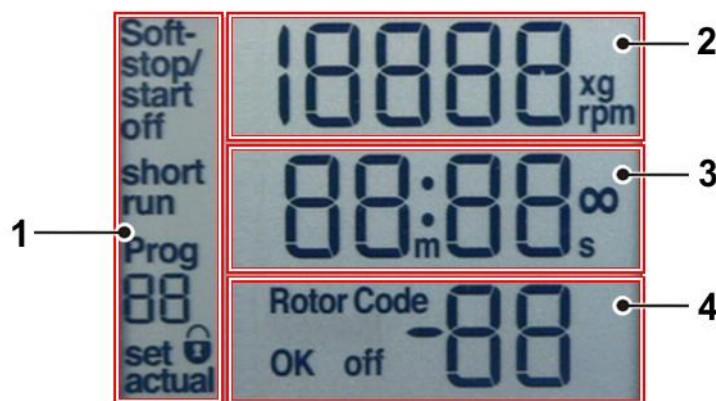

Fig. 7: Display, completely illuminated

6.3.3 Starting a centrifugation run

The centrifuge is ready for operation when the mains power switch is on and the lid is closed.

- Press the start/stop key in order to start a centrifugation run.

During the centrifugation run, "actual" will be displayed in the lower left-hand area of the display.

6.3.4 Interrupting a centrifugation run

- Press the start/stop key in order to interrupt a centrifugation run. The centrifugation run will be terminated prematurely.

6.3.5 Interrupting a deceleration process

- Press the start/stop key during a deceleration process in order to interrupt it and to restart the centrifuge.

6.3.6 Speed / Relative centrifugal force (RCF)

The RCF value is determined by the rotor geometry and speed. The RCF and speed values, therefore, depend on each other. If one of the two values is entered, the other value will be set automatically.

- To enter a value, press the Set button repeatedly until the corresponding unit and the word "set" flash in the lower left-hand area of the display.
- Select the desired speed or RCF value via the arrow keys.

The data will be saved in the following situations:

- When a centrifugation run is started.
- After approx. 20 seconds if no other button is pressed during this time.

During operation, you can switch from the speed value to the RCF value and vice versa via the arrow keys.

6.3.6.1 Changing the speed/RCF value during centrifugation

The preselected speed or RCF value can be changed during centrifugation.

- Press the set key repeatedly until the desired unit flashes on the display.
- Change the speed or RCF value by pressing the arrow keys. The parameters will take effect immediately.

6 Using the centrifuge

6.3.7 Runtime

The preselected total runtime is displayed in the lower line of the display. During centrifugation, the remaining runtime is displayed. The runtime of the centrifuge can be set at one-second-intervals up to 99 minutes and 59 seconds.

- To enter a value, press the Set button repeatedly until the corresponding unit and the word "set" flash in the lower left-hand area of the display.
- Select the desired runtime by pressing the arrow keys.

The data will be saved in the following situations:

- When a centrifugation run is started.
- After approx. 20 seconds if no other button is pressed during this time.

6.3.7.1 Changing the runtime during centrifugation

The preselected runtime can be changed during centrifugation.

- Press the "set" key repeatedly until the time unit flashes on the display.
- Change the desired runtime by pressing the arrow keys. The parameters will be accepted immediately.



If the centrifugation time is changed during the run, the centrifuge will run for the entire new time and will disregard the previous runtime that has already elapsed.

6.3.7.2 Short run

During the short run, the centrifuge accelerates at maximum power until the maximum speed is reached.

- Keep the quick run key pressed during the short run.

The message "short run" and the duration of the short run are displayed. When the quick run key is released, the centrifuge decelerates at maximum power to a standstill.

After the short run, the lid unlocks automatically and the program that was set beforehand is displayed again.

6.3.7.3 Continuous run

During the continuous run, the runtime of the centrifuge is unlimited and must be stopped manually. The centrifuge accelerates during the continuous run until the set speed is reached.

- To start the continuous run, press the set key until the time unit flashes on the display.
- Press the down-key (arrow key) until the display switches from "00:10" to "--:--".

After 99 min 59 sec, any additional runtime will no longer be displayed, but the centrifugation will continue.

- To stop a continuous run, press the start/stop key. The centrifugation will end.
- Enter a runtime. The centrifugation will end after this time.

6.3.8 Softstart and softstop function

The softstart function is used to extend the acceleration time, whereas the softstop function is used to extend the deceleration time. The current combination is shown on the display.

- To activate the softstart and softstop functions, press the set key repeatedly until "Soft-stop/start" flashes in the upper left part of the display.
- Press the arrow keys until "Soft-stop/start on" is displayed. The softstart and softstop functions are now activated.
- Press the arrow key until "Soft stop on" is displayed. Only the softstop function will be active and the centrifuge will start at normal speed.
- Press the arrow key until "Soft off" is displayed. The softstart and softstop functions are now deactivated.

The data will be accepted immediately and saved after approx. 20 seconds. You can also change the settings as described above during a centrifugation run.

6 Using the centrifuge

6.3.9 Rotor selection

In the delivery status of the centrifuge, the rotor 91429 is preselected. If another rotor is installed the configuration must be changed, so that the allowed maximum speed of the rotor can be reached.

- To select another rotor, press the set key and hold it for approx. 2 seconds.
- Choose the number of the installed rotor out of the following list, by pressing the arrow keys:

Code	1	2	3	4	5
Rotor	91429	--	--	--	--
Code	6	7	8	9	10
Rotor	--	--	--	--	--

- Press the set key to confirm the input.

The RCF value will be adjusted automatically to the selected rotor.



The rotor selection will be saved under the corresponding program number.

6.3.10 Programs

Programs are used to save or load certain recurrent settings of the centrifuge. 10 different programs can be saved and called up.

6.3.10.1 Saving the current settings

- Press the program key. Then, select a program number by pressing the arrow keys. The display "Prog - - " will now flash.
- Select the correct rotor.
- Press the set key repeatedly until the corresponding unit flashes on the display. Select the desired parameters.
- In order to save the data, start the centrifuge or press the set key repeatedly until the indication "Prog - -" stops flashing.



Program numbers that are already occupied will be overwritten with the current data.

6.3.10.2 Calling up stored programs

- Press the program key. Then, select a program number by pressing the arrow keys. The display "Prog - - " will now flash.
- Ensure that the correct rotor is installed.
- In order to save the data, start the centrifuge or press the set key repeatedly until the indication "Prog - -" stops flashing.

6.4 Switching the centrifuge off

- Open the centrifuge when it is not in use so that moisture can evaporate.
- Switch the centrifuge off by pressing the mains power switch.

7 Malfunctions and error correction

7 Malfunctions and error correction

7.1 General malfunctions

Malfunctions are indicated by error messages with a number in the speed/RCF display.

In the event of a fatal error (e.g. a defective lid lock), a certain safety time will be counted down on the display. During this time, "ERR" and "SAFE" flash alternately on the display. When the time is up, "OFF" will be displayed.



WARNING

Do not switch the centrifuge off until "OFF" is displayed! This is necessary in order to ensure that the rotor is at a complete standstill.

- Eliminate the source of the problem (see tables below).
- Acknowledge the error messages with the lid key.

Type of error	Possible reason	Correction
No indication on the display	No power in the mains supply	Check fuse in the mains supply
	Power cord is not plugged in	Plug in power cord correctly
	Mains power switch off	Switch mains power switch on
	Lid is not closed correctly	Close the lid
Centrifuge cannot be started: The set speed value is displayed in an unchanged manner	Several possible causes	Netz aus/ein. Falls sich der Fehler wiederholt, Service verständigen
	The lid lock is not closed correctly	Open and close lid. If the error occurs again, contact service
Centrifuge decelerates during operation and displays an error from 1 to 18 after powering on	Several possible causes	Power off/on. If the error occurs again, contact service
Centrifuge decelerates during operation and displays error 19 after powering on	Several possible causes	Acknowledge by pressing the lid key
Lid cannot be opened	Lid locks have not released	Unlock the lid manually (see chapter 7.1.1 - "Emergency lid release") and contact service
	Lid seal sticks	Clean the lid seal and apply talcum powder
Temperature value cannot be reached (only for refrigerated centrifuges)	Condenser dirty	Contact service

7 Malfunctions and error correction

7.1.1 Emergency lid release

In the event of a power failure, it is possible to manually open the centrifuge lid.

- Switch off the mains power switch and disconnect the power cord from the socket.
- Remove the plug (see figure, item 1) from the opening on the left side of the control panel, e.g. with a screwdriver.



Fig. 8: Position of the opening for the emergency lid release

- Insert the supplied hexagon socket key horizontally into the hole and turn it anti-clockwise to the stop. The lid lock will then audibly unlock.



Fig. 9: Manual release of the lid lock

- Then, reinsert the plug.



WARNING

Do not unlock or open the lid unless the rotor is at a standstill.

If the lid is opened via the emergency lid release system during a centrifuge run, the centrifuge will be switched off immediately and decelerate in an unbraked manner.

7 Malfunctions and error correction

7.2 Table of error codes

Error no.	Kind of error	Measures	Note
1-9	System error	<ul style="list-style-type: none"> Allow to slow down Power off/on 	All these errors stop the centrifuge or cause it to decelerate brakeless
10-19	Speedometer error	<ul style="list-style-type: none"> Allow to slow down Power off/on 	
20-29	Motor error	<ul style="list-style-type: none"> Power off Ensure ventilation 	
30-39	EEPROM error	<ul style="list-style-type: none"> Allow to slow down Power off/on 	With error 34, 35, and 36, the centrifuge will stop; with error 37 and 38 only an error message will be given
40-45	Temperature error (only for refrigerated centrifuges)	<ul style="list-style-type: none"> Allow to slow down Power off Allow to cool down Provide better ventilation (only air cooled centrifuges) Provide sufficient water throughput (only water cooled centrifuges) 	
46-49	Imbalance error (only for centrifuges with imbalance monitoring system)	<ul style="list-style-type: none"> Allow to slow down Power off Eliminate the imbalance 	
50-59	Lid error	<ul style="list-style-type: none"> Press lid key Close lid Remove foreign matter from the opening of the lid lock device 	With error 50 and 51, the centrifuge will stop
60-69	Process error	<ul style="list-style-type: none"> Allow to slow down Power off/on 	With error 60, the message "power failure during run" will be displayed, with error 61, the message "stop after power on" will be displayed
70-79	Communication error	<ul style="list-style-type: none"> Allow to slow down Power off/on 	
80-89	Parameter error	<ul style="list-style-type: none"> Power off Allow to cool down Provide for better ventilation 	With error 83, error message only
90-99	Other errors	<ul style="list-style-type: none"> Check connections Provide sufficient water throughput (only water cooled centrifuges) 	



If it is impossible to eliminate the errors, contact the service!

7.3 Service contact

In the event of queries, malfunctions, or spare part enquiries:

From Germany:

Contact

Sigma Laborzentrifugen GmbH
An der Unteren Söse 50
37520 Osterode (Germany)
Tel. +49 (0) 55 22 / 50 07-44 44
E-mail: support.lab@sigma-zentrifugen.de

Outside Germany:

Contact our agency in your country. All agencies are listed at
www.sigma-zentrifugen.de → [Sales Partners]



- If you would like to utilise our service, please state the type of your centrifuge and its serial number.

8 Maintenance and service

8 Maintenance and service

The centrifuge, rotor, and accessories are subject to high mechanical stress. Thorough maintenance performed by the user extends the service life and prevents premature failure.



CAUTION

If corrosion or other damage occurs due to improper care, the manufacturer cannot be held liable or subject to any warranty claims.

- Use soap water or other water-soluble, mild cleaning agents with a pH value between 6 and 8 for cleaning the centrifuge and accessories (see also chapter 8.2 - "Sterilisation and disinfection of the rotor chamber and accessories").
- Avoid corrosive and aggressive substances.
- Do not use solvents.
- Do not use agents with abrasive particles.
- Do not expose the centrifuge and rotors to intensive UV radiation or thermal stress (e.g. by heat generators).

8.1 Maintenance

8.1.1 Centrifuge

- Unplug the mains power plug before cleaning.
- Carefully remove all liquids, including water and particularly all the solvents, acids, and alkaline solutions from the rotor chamber using a cloth in order to avoid damage to the motor bearings.
- If the centrifuge has been contaminated with toxic, radioactive, or pathogenic substances, clean the rotor chamber immediately with a suitable decontamination agent (depending on the type of contamination).



WARNING

Take suitable precautions for your own safety if there is a risk of toxic, radioactive, or pathogenic contamination.

- After every cleaning process, grease the motor shaft slightly with a small amount of heavy-duty grease for load-bearing bolts (part no. 71401) and distribute the grease with a cloth so that it forms a thin layer.

8.1.2 Accessories**CAUTION**

For the care of the accessories, special safety measures must be considered as these are measures that will ensure operational safety at the same time!

- Immediately rinse off the rotor, buckets, or accessories under running water if they have come into contact with any liquids that may cause corrosion. Use a brush for test tubes in order to clean the bores of angle rotors. Turn the rotor upside down and allow it to dry completely.
- Clean the accessories outside the centrifuge once a week or preferably after each use. Adapters should be removed, cleaned and dried.

**CAUTION****Do not clean the accessories in a dishwasher!**

Cleaning in a dishwasher removes the anodised coating; the result is cracking in areas that are subject to stress.

- If the rotors or accessories have been contaminated with toxic, radioactive, or pathogenic substances, clean them immediately with a suitable decontamination agent (depending on the type of contamination). Take suitable precautions for your own safety if there is a risk of toxic, radioactive, or pathogenic contamination.
- Dry the accessories with a soft cloth or in a drying chamber at approx. 50°C.

8.1.2.1 Plastic accessories

The chemical resistance of plastic decreases with rising temperatures (see chapter 11.4 - "Resistance data").

- If solvents, acids, or alkaline solutions have been used, clean the plastic accessories thoroughly.

**WARNING**

Plastic accessories must not be greased!

8 Maintenance and service

8.1.3 Rotors

The rotors are produced with the highest precision, in order to withstand the permanent high stress from high gravitational fields.

Chemical reactions as well as stress-corrosion (combination of oscillating pressure and chemical reaction) can affect or destroy the metals. Barely detectable cracks on the surface can expand and weaken the material without any visible signs.

- Check the material regularly (at least once a month) for
 - cracks
 - visible damage of the surface
 - pressure marks
 - signs of corrosion
 - other changes.
- Check the bores of the rotors and multiple carriers.
- Replace any damaged components immediately for your own safety.

8.1.4 Glass breakage



CAUTION

In the case of glass breakage, immediately remove all glass particles (e.g. with a vacuum cleaner). Replace the rubber cushions since even thorough cleaning will not remove all glass particles.

Glass particles will damage the surface coating (e.g. anodising) of the buckets, which will then lead to corrosion.

Glass particles in the rubber cushions of the buckets will cause glass breakage again.

Glass particles on the pivot bearing of the load-bearing bolts prevent the buckets and carriers from swinging evenly, which will cause an imbalance.

Glass particles in the rotor chamber will cause metal abrasion due to the strong air circulation. This metal dust will not only pollute the rotor chamber, rotor, and materials to be centrifuged but also damage the surfaces of the accessories, rotors, and rotor chamber.

In order to completely remove the glass particles and metal dust from the rotor chamber:

- Grease the upper third of the rotor chamber with e.g. Vaseline.
- Then, let the rotor rotate for a few minutes at a moderate speed (approx. 2000 rpm). The glass and metal particles will now collect at the greased part.
- Remove the grease with the glass and metal particles with a cloth.
- If necessary, repeat this procedure.

8.2 Sterilisation and disinfection of the rotor chamber and accessories

- Use commercially-available disinfectants such as, for example, Sagrotan[®], Buraton[®], or Terralin[®] (available at chemist's shops or drugstores).
- The centrifuge and the accessories consist of various materials. A possible incompatibility must be considered.
- Before using cleaning or decontamination agents that were not recommended by us, contact the manufacturer to ensure that such a procedure will not damage the centrifuge.
- For autoclaving, consider the continuous heat resistance of the individual materials (see chapter 8.2.1 - "Autoclaving").

Please contact us if you have any queries (see chapter 7.3 - "Service contact").



DANGER

If dangerous materials (e.g. infectious and pathogenic substances) are used, the centrifuge and accessories must be disinfected.

8 Maintenance and service

8.2.1 Autoclaving

The service life of the accessories essentially depends on the frequency of autoclaving and use.

- Replace the accessories immediately when the parts show changes in colour or structure or in the occurrence of leaks etc.
- During autoclaving, the caps of the tubes must not be screwed on in order to avoid the deformation of the tubes.



NOTE

It cannot be excluded that plastic parts, e.g. lids or carriers, may deform during autoclaving.

Category	Type of accessory	Material abbreviation	121 °C 20 min	134 °C 20 min	Remarks
Rotors and lids	Aluminium rotors	AL	yes	yes	
	Polypropylen rotors	PP	no	no	
	Polycarbonate lids for angle rotors	PC	no	no	
	Polyallomer lids for angle rotors	PA	no	no	
	Polysulfone lids for angle rotors	PSU	yes	yes	100 cycles max.
Buckets and caps	Aluminium buckets	AL	yes	yes	
	Polyamide buckets	PA	no	no	13035, 13296, 13299
	Polyphenylsulfone caps	PPSU	yes	yes	100 cycles max.
	Polysulfone caps	PSU	yes	yes	100 cycles max.
Adapters	Polyallomer carriers	PA	no	no	
	Polycarbonate carriers	PC	no	no	
	Polypropylene carriers	PP	no	no	
Tubes	Stainless steel tubes and bottles	--	yes	no	
	Glass tubes	--	yes	yes	
	Polyethylene tubes	PE	no	no	
	Polyflor tubes	PF	yes	yes	100 cycles max.
	Polycarbonate tubes	PC	no	no	
	Polypropylene copolymer tubes	PPCO	yes	no	20 cycles max.
	Polystyrene tubes	PS	no	no	
Additional equipment	Stainless-steel balance weight for blood-bag systems	--	yes	no	

8.3 Service



DANGER

In the event of service work that requires the removal of the panels, there is a risk of electric shock or mechanical injury.

- Only qualified specialist personnel is authorised to perform this service work.
- Following the completion of any type of service, the qualified and specialised personnel must perform final inspection and testing in compliance with the relevant standards.

The centrifuge is subject to high mechanical stress. In order to be able to withstand this high level of stress, high-quality components were used during the production of the centrifuge. Nevertheless, wear cannot be excluded and it may not be visible from the outside. Especially the rubber parts that are – among other things – part of the motor suspension, are subject to ageing.

This is why we recommend having the centrifuge checked by the manufacturer during an inspection once per year in the operating state and once every three years in the dismantled state. Motor damping elements must be replaced after three years.

Information and appointments:

In Germany:

Contact

Sigma Laborzentrifugen GmbH

An der Unteren Söse 50

37520 Osterode (Germany)

Tel. +49 (0) 55 22 / 50 07-44 44

E-mail: support.lab@sigma-zentrifugen.de

Outside Germany:

Contact our agency in your country. All agencies are listed at www.sigma-zentrifugen.de → [Sales Partners]



- If you would like to utilise our service, please state the type of your centrifuge and its serial number.

8 Maintenance and service

8.4 Return of defective centrifuges or parts

Although we exercise great care during the production of our products, it may be necessary to return a unit or accessory to the manufacturer.

In order to ensure the quick and economical processing of returns of centrifuges, spare parts, or accessories, we require complete and extensive information concerning the process. Please fill in the following forms completely, sign them, enclose them with the return package, and send them together with the product to:

Sigma Laborzentrifugen GmbH
An der Unteren Söse 50
37520 Osterode (Germany)

1. Declaration of decontamination

As a certified company and due to the legal regulations for the protection of our employees and of the environment, we are obliged to certify the harmlessness of all incoming goods. For this purpose, we require a declaration of decontamination.

- The form must be filled in completely and signed by authorised and specialised personnel only.
- Affix the original form in a clearly visible manner to the outside of the packaging.



We will return the part/unit if no declaration of decontamination is provided!

2. Form for the return of defective parts

This form is for the product-related data. They facilitate the assignment, and they enable the quick processing of the return. If several parts are returned together in one packaging, please enclose a separate problem description for every defective part.

- A detailed problem description is necessary in order to perform the repair quickly and economically.



If the form does not include a description of the malfunction, neither a refund nor a credit note can be issued. In this case, we reserve the right to return the part/unit to you at your expense.

- Upon request, we will prepare and submit to you a cost estimate prior to performing the repair. Please confirm such cost estimate within 14 days. If the cost estimate has still not been confirmed after 4 weeks, we will return the defective part/unit. Please note that you must bear the incurred costs.

8 Maintenance and service



The defective part/unit must be packaged in a transport-safe manner. Please use the original packaging for the unit, if at all possible. If the product is dispatched to us in unsuitable packaging, you will be charged the cost for returning it to you in new packaging.

The forms can be downloaded online from www.sigma-zentrifugen.de → [Service] → [Overhaul and repair].

9 Disposal

9 Disposal

9.1 Disposal of the centrifuge



In accordance with the directive 2012/19/EU, SIGMA centrifuges are marked with the symbol shown to the left. This symbol means that it is not permissible to dispose of the unit among household waste.

- You can return these centrifuges free of cost to Sigma Laborzentrifugen GmbH.
- Ensure that the unit is decontaminated. Fill in a declaration of decontamination (see chapter 8.4 - "Return of defective centrifuges or parts").
- Comply with any other applicable local rules and regulations.

9.2 Disposal of the packaging

- Use the packaging to return the centrifuge for disposal or
- dispose of the packaging, after having separated the individual materials.
- Comply with all local rules and regulations.

10 Technical data

Manufacturer:	Sigma Laborzentrifugen GmbH An der Unteren Söse 50 37520 Osterode (Germany)
Type:	1-7
Order no.:	100011
<u>Connection requirements</u>	
Electrical connection:	see name plate
Protection class:	I
IP code:	20
Power consumption (kW):	0.06 (at 100 - 240 V / 50/60 Hz)
<u>Performance data</u>	
Max. speed (rpm):	8,000
Max. capacity (ml):	72
Max. gravitational field (x g):	6,153
Max. kinetic energy (Nm):	958
<u>Other parameters</u>	
Time range:	10 sec – 99 min 59 sec, short run, continuous run
<u>Physical data</u>	
Height (mm):	271
Height with opened lid (mm):	527
Width (mm):	310
Depth (mm):	418
Weight (kg):	13
Noise level (dB(A)):	60 (at max. speed)

10 Technical data

10.1 Ambient conditions

- The figures are valid for an ambient temperature of +23°C and a nominal voltage $\pm 10\%$.



At a nominal voltage of 100V or 200V, a tolerance of +10% / -5% applies.

- For indoor use only.
- Allowable ambient temperature +5°C to +40°C.
- Max. allowable relative humidity of air 80% from 5°C up to 31°C with a linear decrease to 50% relative humidity of air at 40°C.
- Maximum altitude 2,000 m above sea level.

10.2 Technical documentation

For environmental reasons, the comprehensive technical documentation of the centrifuge (e.g. circuit diagrams) and the safety data sheets of the manufacturers of refrigerants and lubricants are not attached to this documentation.

You can order these documents from our service department.

11 Appendix

11.1 Range of accessories

The complete list of accessories can be downloaded from www.sigma-zentrifugen.de.

11.1.1 Rotor radii

The information in the accessories table concerning the radius refers to the values of the respective rotor as shown below. The radius calculation is described in chapter 2.2.2.1 - "Speed, radius, and relative centrifugal force".

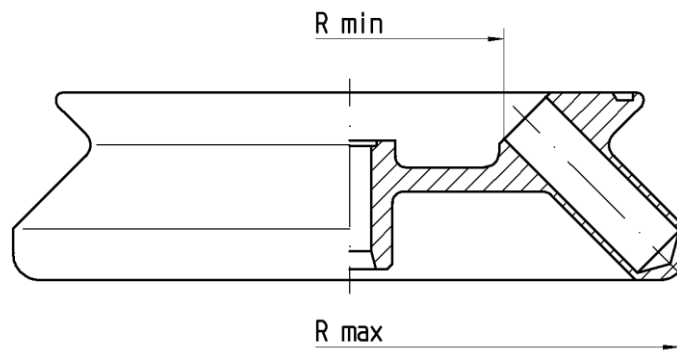

Fig. 10 Minimum and maximum radius of an angle rotor

11 Appendix

11.2 Speed-gravitational-field-diagram

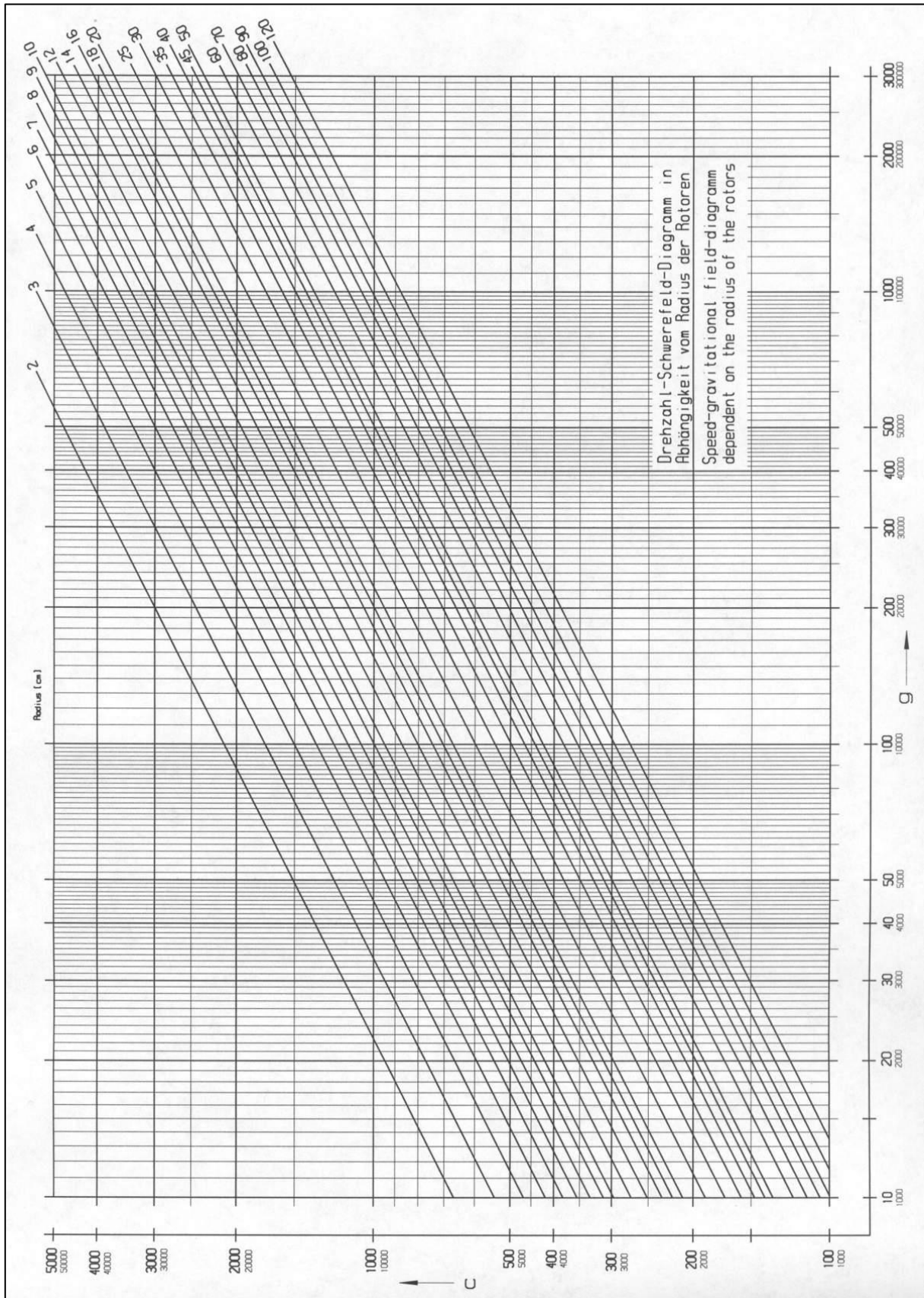

Fig. 11: Speed-gravitational-field-diagram

11.3 Table of the service life of rotors and accessories

- If no other data concerning the service life are engraved on the rotor or accessory, rotors and buckets must be checked by the manufacturer after 10 years.
- If a specification concerning the maximum number of cycles **and** a specification concerning the service life (i.e. a date) are provided, the specification that occurs first shall apply.
- After 50,000 cycles, rotors must be scrapped for safety reasons.

Rotor / bucket	Cycles	Service life ("Exp.Date")	Suitable for centrifuge	Remarks
9100	35,000		4-16S, 4-16KS, 4-16KHS, 6-16S, 6-16HS, 6-16KS, 6-16KHS	
9366	15,000		4-5KL, 4-16S, 4-16KS, 4-16KHS, 6-16S, 6-16HS, 6-16KS, 6-16KHS	
11805		10 years	8KS, 8KBS	
11806		10 years	8KS, 8KBS	
12082		7 years	1-14, 1-14K	
12083		7 years	1-14, 1-14K	
12084		7 years	1-14, 1-14K	
12085		7 years	1-14, 1-14K	
12092		5 years	1-14, 1-14K	
12093		5 years	1-14, 1-14K	
12094		5 years	1-14, 1-14K	
12096		5 years	1-14, 1-14K	
12097		5 years	1-14, 1-14K	
12134		5 years	1-16, 1-16K	
12135		5 years	1-16, 1-16K	
12137		5 years	1-16, 1-16K	
12500		7 years	6-16S, 6-16HS, 6-16KS, 6-16KHS	
12600		7 years	6-16S, 6-16HS, 6-16KS, 6-16KHS	
13035			2-7	Do not grease the load-bearing bolts of the rotor
13218	20,000		4-16S, 4-16KS, 4-16KHS, 6-16S, 6-16HS, 6-16KS, 6-16KHS	
13221	10,000		4-16S, 4-16KS, 4-16KHS, 6-16S, 6-16HS, 6-16KS, 6-16KHS	
13296	35,000	5 years	2-7, 2-16P, 2-16KL, 2-16KHL	Do not grease the load-bearing bolts of the rotor
13299		5 years	2-7, 2-16P, 2-16KL, 2-16KHL, 3-30KS, 3-30KHS	Do not grease the load-bearing bolts of the rotor
13635	25,000		6-16S, 6-16HS, 6-16KS, 6-16KHS	
13650	20,000		6-16S, 6-16HS, 6-16KS, 6-16KHS	
13845	20,000		8KS	
13850	10,000	10 years	8KS	
13860	15,000	10 years	8KBS	
91060	10,000		6-16S, 6-16HS	Special software required

11 Appendix

11.4 Resistance data



The data refer to resistance at 20°C.

- no data 1 resistant 2 practically resistant 3 partially resistant 4 not resistant	Concentration	High Density Polyethylene	Polyamide	Polycarbonate	Polyoxymethylene	Polypropylene	Polysulfone	Polyvinyl chloride, hard	Polyvinyl chloride, soft	Polytetrafluorethylene	Acrylonitrile-butadiene-caoutchouc	Aluminium	
													Medium
Acetaldehyde	C ₂ H ₄ O	40	3	2	4	2	3	4	4	-	1	4	1
Acetamide	C ₂ H ₅ NO	saturated	1	1	4	1	1	4	4	-	1	-	1
Acetone	C ₃ H ₆ O	100	1	1	4	1	1	4	4	-	1	4	1
Acrylonitrile	C ₃ H ₃ N	100	1	1	4	3	3	4	4	4	1	4	1
Allyl alcohol	C ₃ H ₆ O	96	1	3	3	2	2	2	2	4	1	1	1
Aluminium chloride	AlCl ₃	saturated	1	3	2	4	1	-	1	-	1	1	4
Aluminium sulfate	Al ₂ (SO ₄) ₃	10	1	1	1	3	1	1	1	1	1	1	1
Ammonium chloride	(NH ₄)Cl	aqueous	1	1	1	2	1	1	1	1	1	1	3
Ammonium hydroxide	NH ₃ + H ₂ O	30	1	3	4	1	1	2	1	-	1	-	1
Aniline	C ₆ H ₇ N	100	1	3	4	1	2	4	4	4	1	4	1
Anisole	C ₇ H ₈ O	100	3	4	4	1	4	4	2	-	1	4	1
Antimony trichloride	SbCl ₃	90	1	4	1	4	1	-	1	-	1	-	4
Benzaldehyde	C ₇ H ₆ O	100	1	3	4	1	1	3	4	4	1	4	1
Benzene	C ₆ H ₆	100	3	2	4	1	3	4	4	-	1	4	1
Boric acid	H ₃ BO ₃	aqueous	1	3	1	2	1	-	-	-	1	1	1
Butyl acrylate	C ₇ H ₁₂ O ₂	100	1	2	4	2	3	4	4	4	1	-	1
Butyl alcohol, normal	C ₄ H ₁₀ O	100	1	1	2	1	1	2	2	4	1	1	1
Calcium chloride	CaCl ₂	alcoholic	1	4	2	3	1	-	-	4	1	1	3
Carbon disulfide	CS ₂	100	4	3	4	2	4	4	4	4	1	3	1
Carbon tetrachloride (TETRA)	CCl ₄	100	4	4	4	2	4	4	4	4	1	3	1
Chlorine	Cl ₂	100	4	4	4	4	4	4	4	4	1	-	3
Chlorine water	Cl ₂ x H ₂ O		3	4	4	4	3	-	3	3	1	-	4
Chlorobenzene	C ₆ H ₅ Cl	100	3	4	4	1	3	4	4	4	1	4	1
Chloroform	CHCl ₃	100	3	3	4	4	3	4	4	4	1	4	3

11 Appendix

- no data 1 resistant 2 practically resistant 3 partially resistant 4 not resistant		Concentration	High Density Polyethylene	Polyamide	Polycarbonate	Polyoxymethylene	Polypropylene	Polysulfone	Polyvinyl chloride, hard	Polyvinyl chloride, soft	Polytetrafluorethylene	Acrylonitrile-butadiene-caoutchouc	Aluminium	
			Medium	Formula	[%]	HDPE	PA	PC	POM	PP	PSU	PVC	PVC	PTFE
	Chromic acid	CrO ₃	10	1	4	2	4	1	4	1	-	1	4	1
	Chromic potassium sulphate	KCr(SO ₄) ₂ x 12H ₂ O	saturated	1	2	1	3	1	-	1	-	1	-	3
	Citric acid	C ₆ H ₈ O ₇	10	1	1	1	2	1	1	1	1	1	1	1
	Citric acid	C ₆ H ₈ O ₇	50	1	3	1	2	1	-	-	-	1	1	1
	Copper sulphate	CuSO ₄ x 5H ₂ O	10	1	1	1	1	1	1	1	1	1	1	4
	Cyclohexanol	C ₆ H ₁₂ O	100	1	1	3	1	1	1	1	4	1	2	1
	Decane	C ₁₀ H ₂₂	100	-	1	2	1	3	-	-	-	1	2	1
	Diaminoethane	C ₂ H ₈ N ₂	100	1	1	3	1	1	-	3	4	1	1	1
	Diesel fuel	—	100	1	1	3	1	1	-	1	3	1	1	1
	Dimethyl formamide (DMF)	C ₃ D ₇ NO	100	1	1	4	1	1	4	3	-	1	3	1
	Dimethyl sulfoxide (DMSO)	C ₂ H ₆ SO	100	1	2	4	1	1	4	4	-	1	-	1
	Dimethylaniline	C ₈ H ₁₁ N	100	-	3	4	2	4	-	-	-	1	-	1
	Dioxane	C ₄ H ₈ O ₂	100	2	1	4	1	3	2	3	4	1	3	1
	Dipropylene glycol (mono)methyl ether	C ₄ H ₁₀ O	100	3	1	4	1	4	4	4	4	1	-	1
	Ethyl acetate	C ₄ H ₈ O ₂	100	1	1	4	1	1	4	4	4	1	4	1
	Ethylene chloride	C ₂ H ₄ Cl ₂	100	3	3	4	1	3	4	4	4	1	-	1
	Ferrous chloride	FeCl ₂	saturated	1	3	1	3	1	1	1	1	1	-	4
	Formaldehyde solution	CH ₂ O	30	1	3	1	1	1	-	-	-	1	2	1
	Formic acid	CH ₂ O ₂	100	1	4	3	4	1	3	3	1	1	2	1
	Furfural	C ₅ H ₄ O ₂	100	1	3	3	2	4	-	-	-	1	4	1
	Gasoline	C ₅ H ₁₂ - C ₁₂ H ₂₆	100	2	1	3	1	3	3	2	-	1	1	1
	Glycerol	C ₃ H ₈ O ₃	100	1	1	3	1	1	1	1	2	1	1	1
	Heptane, normal	C ₇ H ₁₆	100	2	1	1	1	2	1	2	4	1	1	1
	Hexane, n-	C ₆ H ₁₄	100	2	1	2	1	2	1	2	4	1	1	1
	Hydrogen chloride	HCl	5	1	4	1	4	1	1	1	-	1	2	4
	Hydrogen chloride	HCl	concentrated	1	4	4	4	1	1	2	3	1	4	4
	Hydrogen peroxide	H ₂ O ₂	3	1	3	1	1	1	1	1	-	1	3	3
	Hydrogen peroxide	H ₂ O ₂	30	1	4	1	4	1	1	1	-	1	3	3
	Hydrogen sulphide	H ₂ S	10	1	1	1	1	1	1	1	3	1	3	1
	Iodine, tincture of	I ₂		1	4	3	1	1	-	4	4	1	1	1

11 Appendix

- no data 1 resistant 2 practically resistant 3 partially resistant 4 not resistant	Medium	Formula	Concentration [%]	High Density Polyethylene	Polyamide	Polycarbonate	Polyoxymethylene	Polypropylene	Polysulfone	Polyvinyl chloride, hard	Polyvinyl chloride, soft	Polytetrafluorethylene	Acrylonitrile-butadiene- caoutchouc	Aluminium
				HDPE	PA	PC	POM	PP	PSU	PVC	PVC	PTFE	NBR	AL
	Isopropyl alcohol	C ₃ H ₈ O	100	1	1	1	1	1	1	1	4	1	-	2
	Lactic acid	C ₃ H ₆ O ₃	3	1	3	1	2	1	1	2	-	1	1	1
	Magnesium chloride	MgCl ₂	10	1	1	1	1	1	1	1	1	1	1	1
	Mercuric chloride	HgCl ₂	10	1	4	1	3	1	1	1	1	1	1	4
	Mercury	Hg	100	1	1	1	1	1	1	1	3	1	1	3
	Methyl acetate	C ₃ H ₆ O ₂	100	1	1	4	2	1	-	4	4	1	-	1
	Methyl alcohol	CH ₄ O	100	1	2	4	1	1	3	1	3	1	2	1
	Methyl benzene	C ₇ H ₈	100	3	1	4	1	3	4	4	4	1	4	1
	Methyl ethyl ketone (MEK)	C ₄ H ₈ O	100	1	1	4	1	1	4	4	4	1	4	1
	Methylene chloride	CH ₂ Cl ₂	100	4	3	4	3	3	4	4	4	1	-	1
	Mineral oil	—	100	1	1	1	1	1	1	1	-	1	1	1
	Nitric acid	HNO ₃	10	1	4	1	4	1	1	1	-	1	4	3
	Nitric acid	HNO ₃	100	4	4	4	4	4	-	4	-	1	4	1
	Nitrobenzene	C ₆ H ₅ NO ₂	100	3	4	4	3	2	4	4	4	1	4	1
	Oleic acid	C ₁₈ H ₃₄ O ₂	100	1	1	1	2	1	-	1	-	1	3	1
	Oxalic acid	C ₂ H ₂ O ₄ x 2H ₂ O	100	1	3	1	4	1	1	1	1	1	2	1
	Ozone	O ₃	100	3	4	1	4	3	1	1	-	1	4	2
	Petroleum	—	100	1	1	3	1	1	1	1	3	1	1	1
	Phenol	C ₆ H ₆ O	10	1	4	4	4	1	4	1	3	1	3	1
	Phenol	C ₆ H ₆ O	100	2	4	4	4	1	3	4	3	1	3	1
	Phosphoric acid	H ₃ PO ₄	20	1	4	2	4	1	-	-	-	1	2	4
	Phosphorus pentachloride	PCl ₅	100	-	4	4	4	1	-	4	4	1	-	1
	Potassium hydrogen carbonate	CHKO ₃	saturated	1	1	2	1	1	-	-	-	1	-	4
	Potassium hydroxide	KOH	30	1	1	4	3	1	1	1	1	1	-	4
	Potassium hydroxide	KOH	50	1	1	4	3	1	1	1	1	1	-	4
	Potassium nitrate	KNO ₃	10	1	1	1	1	1	-	-	-	1	1	1
	Potassium permanganate	KMnO ₄	100	1	4	1	1	1	-	1	-	1	3	1
	Pyridine	C ₅ H ₅ N	100	1	1	4	1	3	4	4	4	1	4	1
	Resorcinol	C ₆ H ₆ O ₂	5	1	4	2	3	1	4	2	-	1	-	2
	Silver nitrate	AgNO ₃	100	1	1	1	1	1	1	1	1	1	2	4

11 Appendix

- no data 1 resistant 2 practically resistant 3 partially resistant 4 not resistant		Concentration	High Density Polyethylene	Polyamide	Polycarbonate	Polyoxymethylene	Polypropylene	Polysulfone	Polyvinyl chloride, hard	Polyvinyl chloride, soft	Polytetrafluorethylene	Acrylonitrile-butadiene-caoutchouc	Aluminium
			Medium	Formula	[%]	HDPE	PA	PC	POM	PP	PSU	PVC	PVC
	Sodium bisulphite	NaHSO ₃	10	1	1	2	4	1	-	-	1	1	1
	Sodium carbonate	Na ₂ CO ₃	10	1	1	1	1	1	-	-	1	-	3
	Sodium chloride	NaCl	30	1	1	1	1	1	1	1	1	1	3
	Sodium hydroxide	NaOH	30	1	1	4	1	1	1	1	1	2	4
	Sodium hydroxide	NaOH	50	1	1	4	1	1	1	1	-	2	4
	Sodium sulfate	Na ₂ SO ₄	10	1	1	1	1	1	1	1	1	1	1
	Spirits	C ₂ H ₆ O	96	1	1	1	1	1	1	3	1	-	1
	Styrene	C ₈ H ₈	100	4	1	4	1	3	-	4	4	4	1
	Sulphuric acid	H ₂ SO ₄	6	1	4	1	4	1	1	1	-	2	3
	Sulphuric acid	H ₂ SO ₄	fuming	4	4	4	4	4	4	4	4	4	3
	Tallow	—	100	1	1	1	1	1	-	1	1	1	1
	Tetrahydrofuran (THF)	C ₄ H ₈ O	100	3	1	4	1	3	4	4	4	3	1
	Tetrahydronaphthalene	C ₁₀ H ₁₂	100	3	1	4	1	4	4	4	4	-	1
	Thionyl chloride	Cl ₂ SO	100	4	4	4	2	4	4	4	4	-	3
	Tin chloride	SnCl ₂	10	1	4	2	2	1	-	-	1	1	4
	Transformer oil	—	100	1	1	3	3	1	1	1	-	1	1
	Trichloroethane	C ₂ H ₃ Cl ₃	100	3	3	4	2	4	4	4	4	4	4
	Urea	CH ₄ N ₂ O	10	1	1	1	1	1	-	-	1	1	1
	Urine	—	100	1	1	1	1	1	-	1	1	-	2
	Vinegar	C ₂ H ₄ O ₂	10	1	4	1	1	1	1	1	1	2	1
	Vinegar	C ₂ H ₄ O ₂	90	1	4	4	4	1	3	1	4	-	1
	Wax	—	100	-	1	1		1	-	-	1	-	1
	Wines	—	100	1	1	1	2	1	1	1	1	-	4
	Xylene	C ₈ H ₁₀	100	3	1	4	1	4	4	4	4	4	1

11 Appendix

11.5 EC declaration of conformity



EC – DECLARATION OF CONFORMITY

The product named hereinafter was developed, designed, and manufactured in compliance with the relevant, fundamental safety and health requirements of the listed EC directives and norms.

In the event of modifications that were not authorised by us or if the product is used in a manner that is not in line with the intended purpose, this declaration will be rendered void.

<i>Product name:</i>	Laboratory centrifuge
<i>Product type:</i>	Sigma 1-7
<i>Order number:</i>	100011
<i>Directives:</i>	2006/42/EC Machinery Directive 2014/35/EU Low Voltage Directive 2014/30/EU EMC Directive (EU) 2015/863 RoHS Directive
<i>Normes:</i>	EN 61010-2-020:2017 EN IEC 61000-3-2:2019 EN 61000-3-3:2020 EN 61326-1:2013

Sigma Laborzentrifugen GmbH

An der Unteren Söse 50
37520 Osterode
Germany

Authorised representative
for CE matters:
Eckhard Tödteberg

Osterode, 07/04/2022



General Manager

11 Appendix

11.6 Declaration of conformity – China RoHS 2



DECLARATION OF CONFORMITY

China RoHS 2 (Administrative Measures for the Restriction of the Use of Hazardous Substances in Electrical and Electronic Products)

Laboratory centrifuge models: Sigma 1-14, 1-14K, 1-7, 1-16, 1-16K, 2-7, 2-16P, 2-16KL, 2-16KHL, 3-16L, 3-16KL, 3-18KS, 3-18KHS, 3-30KS, 3-30KHS, 4-5L, 4-5KL; 4-5KRL, 4-16S, 4-16KS, 4-16KHS, 6-16S, 6-16HS, 6-16KS, 6-16KHS, 8KS, 8KBS

Sigma Laborzentrifugen GmbH has made reasonable effort to avoid the use of hazardous substances in the products it manufactures (laboratory centrifuges).

A Product Conformity Assessment (PCA) was performed in order to determine whether the concentration of harmful substances in all homogeneous materials of the component parts is above or below the MCV limit (Maximum Concentration Value limit) as defined in GB/T 26572:

Mercury and its compounds: 0.1 % Cadmium (Cd) and its compounds: 0.01 %
 Lead (Pb) and its compounds: 0.1 % Hexavalent chromium (Cr (VI)) and its compounds: 0.1 %
 Polybrominated biphenyls (PBB): 0.1 % Polybrominated diphenyl ethers (PBDE): 0.1 %

表1 产品中有害物质的名称及含量
 Table 1: Name and content of hazardous substances in the product

部件名称 Component part (PCA)	有害物质 Hazardous substance					
	铅 Lead (Pb)	汞 Mercury (Hg)	镉 Cadmium (Cd)	六价铬 Hexavalent Chromium (Cr (VI))	多溴联苯 Poly-brominated biphenyls (PBB)	多溴二苯醚 Polybrominated diphenyl ethers (PBDE)
Electronic PCB, cables	X ¹⁾	○	○	○	○	○
Display	○	○	○	○	○	○
Housing	X ²⁾	○	○	○	○	○
Base, metal, accessories	X ²⁾	○	○	○	○	○

本表格依据SJ/T 11364的规定编制。
 This table is made according to SJ/T 11364.

11 Appendix



- O: 表示该有害物质在该部件所有均质材料中的含量均在GB/T 26572规定的限量要求以下。
Indicates that the content of the harmful substance in all homogeneous materials of the component part is below the limit as defined in GB/T 26572.)
- X: 表示该有害物质至少在该部件的某一均质材料中的含量超出GB/T 26572规定的限量要求。(企业可在此处, 根据实际情况对上表打“X”的技术原因进行进一步说明。)
Indicates that the content of the harmful substance in at least one homogeneous material of the component part exceeds the limit as defined in GB/T 26572. (Contact the manufacturer for further technical information according to the actual situation.)
- 1) Contains parts in compliance with exemptions 6c, 7c.I, 7c.II and 37 of 2011/65/EU RoHS.
- 2) Contains parts in compliance with exemptions 6a, 6b and 6c of 2011/65/EU RoHS.

Apart from the exemptions given in this table, none of the substances listed above have been intentionally added to the product or metallic coatings.

Sigma Laborzentrifugen GmbH

An der Unteren Söse 50
37520 Osterode
Germany

Osterode, 08/11/2023



M. Weigoni, Director of Procurement

11.7 UKCA declaration of conformity



UKCA – DECLARATION OF CONFORMITY

The product named hereinafter was developed, designed, and manufactured in compliance with the relevant, fundamental safety and health requirements of the listed directives and norms.

In the event of modifications that were not authorised by us or if the product is used in a manner that is not in line with the intended purpose, this declaration will be rendered void.

<i>Product name:</i>	Laboratory centrifuge
<i>Product type:</i>	Sigma 1-7
<i>Order number:</i>	100011
<i>Manufacturer:</i>	Sigma Laborzentrifugen GmbH An der Unteren Söse 50 37520 Osterode am Harz Germany
<i>Directives:</i>	Supply of Machinery (Safety) Regulations 2008 Electrical Equipment (Safety) Regulations 2016 Electromagnetic Compatibility Regulations 2016 Restriction of the Use of Certain Hazardous Substances in Electrical and Electronic Equipment Regulations 2012
<i>Normes:</i>	EN 61010-2-020:2017 EN IEC 61000-3-2:2019 EN 61000-3-3:2020 EN 61326-1:2013

UK Authorised Representative:	 SciQuip Ltd Newtown Wem Shropshire SY4 5NU
Osterode, 19/10/2022	
	
General Manager	

11 Appendix

12 Index

A	
Acceleration time	
- see also the softstart and softstop function	
.....	35
Accessories	
changes in colour.....	46
changes in structure	46
deformation of tubes	46
Leaks.....	46
Accessories, cleaning and care.....	43
Acid.....	22, 42, 43
Adapters	43
Alkaline solutions	22, 42, 43
Ambient conditions.....	52
Ambient temperature	52
Anodised coating	43
Application examples	13
Autoclaving	46
C	
Calling up stored programs	37
Capacity.....	51
CE mark in compliance with the directive	
2006/42/EC	15
Centrifugation of infectious, toxic, radioactive,	
or pathogenic substances.....	21
Centrifugation principle	13
Centrifugation with low capacity	31
Centrifuge cannot be started.....	38
Centrifuge decelerates during operation	38
Centrifuge, cleaning and care	42
Centrifuges	
- definition.....	9
Changes in colour (accessories).....	46
Changes in structure (accessories).....	46
Changing the runtime during centrifugation	
.....	34
Changing the speed/RCF value during	
centrifugation.....	33
Chemical and biological safety.....	21
Chemical resistance of plastic.....	43
Cleaning agents.....	45
Cleaning the bores of angle rotors	43
Cleaning the centrifuge	42
Closing the lid	20, 29
Communication error	40
Condensation.....	27
Contamination.....	21, 43
Continuous heat resistance.....	45
Continuous run	35
Copyright	10
Corrosion	20, 23, 31, 42, 43, 44
Cost estimate.....	48
Cracking	43
Cracks	44
Customer-provided fuses	28
D	
Damage of the surface.....	44
Dangerous goods.....	22
Dangerous materials.....	45
Date of manufacture	12
Deceleration time	
- see also the softstart and softstop function	
.....	35
Declaration of conformity	10, 61
Declaration of decontamination.....	48, 50
Decontamination agent	43, 45
Deformation of tubes (accessories).....	46
Density.....	12, 22
Different service life of rotors and accessories	
.....	23, 55
Dimensions	25
Direct hazard to the life and health.....	16
Directive 2002/96/EC	50
Disinfectants	45
Disinfection of the rotor chamber and	
accessories	45
Disposal of the centrifuge.....	50
Disposal of the packaging	50
Documentation.....	10
E	
Earth conductor check	24
EC declaration of conformity	10, 61
EEPROM error.....	40

Index

Electrical connection	51	L	
Electrical safety	20	Layout of the centrifuge.....	11
Emergency lid release	39	Leaks (accessories	46
Error correction	38	Lid cannot be opened	38
Error messages	38	Lid error	40
Explanation of the symbols and notes.....	16	Lid is not closed correctly.....	38
Explosive substances	21	Lid lock device	23
F		Lid lock has not released	38
Fatal error	38	Lid lock is not closed correctly.....	38
Fire preventions	21	Lid seal sticks	38
Form for the return of defective parts	48	M	
Functional and operating elements	11	Mains power switch off.....	38
G		Mains voltage.....	20
General conditions	9	Maintenance	42
General malfunctions	38	Malfunction	38
Glass breakage.....	44	Malfunctions and error correction.....	38
Glass particles	44	Manual release of the lid lock.....	39
Gravitational field	51	Manufacturer.....	51
Grease for load-bearing bolts.....	42	Marking of the unit	15
H		Measures in the event of hazards and accidents	24
Hazard warnings.....	9, 30, 31	Mechanical safety	20
Highly corrosive substances	21	Mode of operation	13
I		Motor error	40
Imbalance	31	Motor shaft.....	42
Imbalance error.....	40	N	
Importance of the operating manual.....	9	Name plate	12
Important information	16	No indication on the display	38
Infectious substances	45	No power in the mains supply	38
Inflammable substances	21	Noise level	51
Informal safety instructions	19	Nominal voltage	12
Initial start-up	29	Notes on safety and hazards	9
Inspection by the manufacturer	47	Notes on transport	25
Installation of a rotor	30	O	
Installation of accessories	31	Online download of forms	49
Installation of rotors and accessories	30	Opening the lid.....	29
Installation site	27	Operating personnel	18
Intended use	9	Operating voltage.....	27
Interrupting a centrifugation run	33	Operational safety.....	43
Interrupting a deceleration process	33	Overseas shipping	25
IP code	51	P	
K		Packaging	26
Kinetic energy	12, 51	Parameter error	40

Pathogenic substances	21, 42, 45	Safety, chemical and biological	21
Plastic accessories, cleaning and care.....	43	Safety, electrical	20
Potential hazard to the life and health	16	Safety, mechanical.....	20
Potentially hazardous situation.....	16	Safety-conscious work	17
Power consumption	12, 51	Saving the current settings.....	37
Power cord is not plugged in.....	38	Scope of supply	10
Power supply	27	Serial number	12, 41, 47
Pressure marks.....	44	Service.....	47
Prevention of accidents.....	9	Service contact	41
Problem description	48	Service life	42
Process error	40	Service life of rotors and accessories... 23, 55	
Programs	37	Service life of the accessories.....	46
Protection class	27, 51	Service work	47
Q		Set-up and connection	27
Qualified electrician.....	18	Short run.....	34
Quick run	34	Softstart and softstop function.....	35
R		Solvents.....	22, 42, 43
Radioactive substances	21, 42	Spare part enquiries.....	41
Radius	14	Specialised personnel.....	18
RCF	33	Speed	12, 14, 33, 51
Relative centrifugal force (RCF).....	14, 33	Speed-gravitational-field-diagram	54
Remove glass particles and metal dust from the rotor chamber	44	Speedometer error.....	40
Removing a rotor	30	Spincontrol Basic	32
Requirements concerning the personnel....	18	Standards and regulations	10
Responsibility of the operator.....	17	Standstill monitoring system	24
Return of centrifuges, spare parts, or accessories	48	Starting a centrifugation run	33
Return of defective parts	48	Sterilisation of the rotor chamber and accessories	45
Rotor chamber	42	Storage and transport	25
Rotor radii	53	Storage conditions	25
Rotor wrench	30	Stress-corrosion	
Rotors and accessories with a different service life	23, 55	see	
Rotors, cleaning and care	44	corrosion	44
Runtime	34	Structural changes.....	21
S		Supply voltage	27
Safety area	22	Switching the centrifuge off	37
Safety devices	23	System check	24
Safety distance	20	System error	40
Safety instructions.....	9, 30, 31	T	
Safety instructions concerning the centrifugation process	22	Table of error codes.....	40
Safety of rotors and accessories	23	Table of rotors and accessories with a different service life	23, 55
Safety range	22, 27	Technical data	51
		Technical documentation	52
		Temperature error.....	40

Index

Temperature value cannot be reached.....	38	Units of protection class I	27
Thermal stress	42	User interface	32
Time range.....	51	UV radiation	27, 42
Toxic substances	21, 42	V	
Transport safety device.....	26	Vents	27
Type.....	12, 51	W	
Type of connection.....	27	Warranty and liability.....	9
Type of the centrifuge	41, 47	Wear	47
U		Weight	25
UKCA declaration of conformity	65		